



HERRAJES
DE **ANDALUCÍA**

INTHER

Kit correderas



INTHER
^



KC

KIT
CORREDERAS

HERRAJES
PARA PROYECTOS TÉCNICOS

06.4 KIT CORREDERAS

KIT DESL. G500T COND.



Págs

302

KIT DESL G500T LLAVE



Págs

303

KIT 2 Y 1 G500T



Págs

304

KIT INOX



Págs

305

KIT DESL. 101/102 COND.



Págs

306

KIT DESL. 103/104 LLAVE



Págs

307

KIT COND.



Págs

308

KIT LLAVE



Págs

309

KIT 2 Y 1



Págs

310





Cerraduras Puertas Correderas

- Inther aporta a los sistemas de cierre para puertas correderas, una amplia gama de productos.
- Sistemas como el **Desl 101/102 y G500T**, son auténticas novedades por su **sistema patentado** de cierre. El accionamiento se realiza a través de su sistema frontal.
- Se incluye también como novedad, **los kits en acero inoxidable 304**.



INTHER
^

KC
KIT CORREDERAS





Kit Desl. G500T Cond.



Kit Desl. G500T Llave



Kit Inox.



Kit Desl. 101/102 Cond.



Kit Desl. 103/104 Llave



Kit Cond.



Kit Llave



Kit 2 y 1

Kit Correderas

KIT DESL. G500T COND.

INTHER



PATENTADO

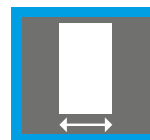

Grosor 34/50 mm.



Patentado

Características técnicas

- Diseño moderno y minimalista.
- Novedoso sistema de ayuda para el cierre de la puerta.
- Caja extremadamente compacta para optimizar el mecanizado.
- Alta fiabilidad y accionamiento suave.
- Incluye plantilla de montaje del cerradero y cajetín.
- Productos disponible en terminación cuadrada y redonda.

Código	Descripción	Tipo	Acabado	Set
15573	Kit Desl. G500T Cond.	C/C	CM	1/40
15572	Kit Desl. G500T Cond.	C/R	CM	1/40
15576	Kit Desl. G500T Cond.	C/C	NE	1/40
15575	Kit Desl. G500T Cond.	C/R	NE	1/40
15577	Kit Desl. G500T Cond.	C/R	BL	1/40
15574	Kit Desl. G500T Cond.	C/R	LP	1/40

Plano

Sistema Tradicional

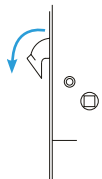

Sistema Desl.

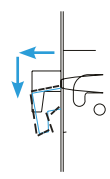

Agujero entrado

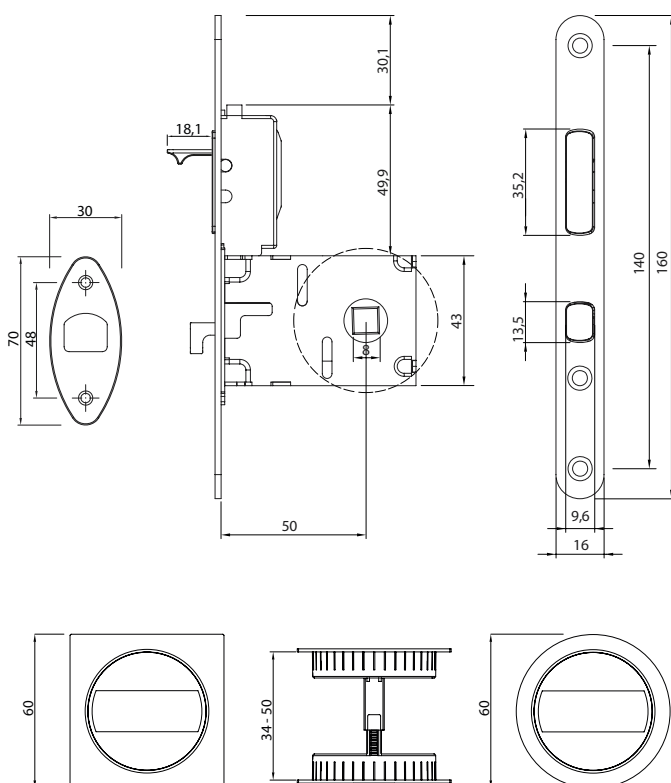
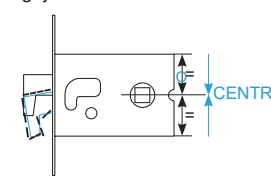

Descarga la ficha técnica en www.inther.es

Kit Correderas

KIT DESL. G500T LLAVE

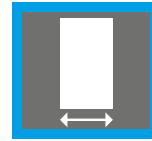

Grosor 34/50 mm.



Patentado



PATENTADO

Características técnicas

- Diseño moderno y minimalista.
- Novedoso sistema de ayuda para el cierre de la puerta.
- Caja extremadamente compacta para optimizar el mecanizado.
- Alta fiabilidad y accionamiento suave.
- Incluye plantilla de montaje del cerradero y cajetín.
- Productos disponible en terminación cuadrada y redonda.

Código	Descripción	Tipo	Acabado	Set
15579	Kit Desl. G500T Llave	C/C	CM	1/40
15578	Kit Desl. G500T Llave	C/R	CM	1/40
15600	Kit Desl. G500T Llave	C/C	NE	1/40
15599	Kit Desl. G500T Llave	C/R	NE	1/40
15598	Kit Desl. G500T Llave	C/R	LP	1/40

Plano

* No incluye cilindro

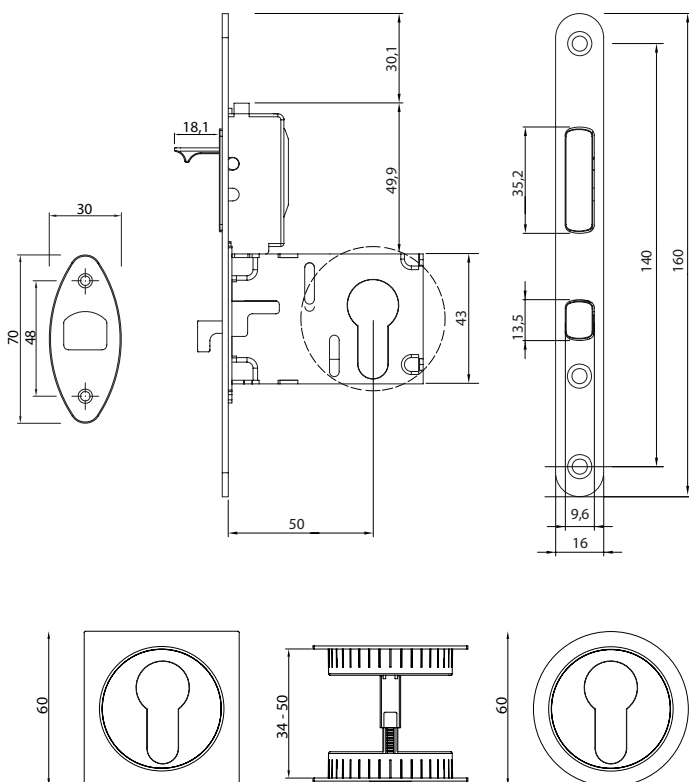
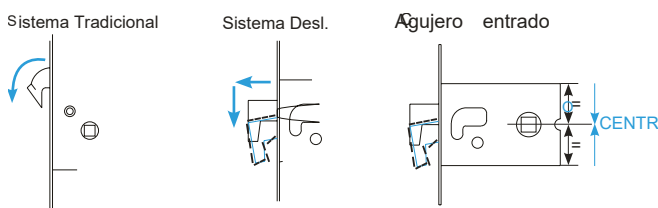

Descarga la ficha técnica en www.inther.es



Canto cuadrado (CC)



Canto redondo (CR)

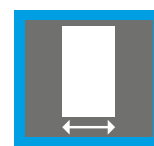

Grosor 35 >

Características técnicas

- Diseño moderno y minimalista.
- Novedoso sistema de ayuda para el cierre de la puerta.
- Caja extremadamente compacta para optimizar el mecanizado.
- Alta fiabilidad y accionamiento suave.
- Incluye plantilla de montaje del cerradero y cajetín.
- Productos disponible en terminación cuadrada y redonda.

Canto cuadrado

Código	Descripción	Tipo	Acabado	Set
16115	Tirador 2 y 1 G5T	C/C	CM	1/40
16116	Tirador 2 y 1 G5T	C/C	NS	1/40
16117	Tirador 2 y 1 G5T	C/C	NE	1/40
16118	Tirador 2 y 1 G5T	C/C	LP	1/40

Canto redondo

Código	Descripción	Tipo	Acabado	Set
15994	Tirador 2 y 1 G5T	C/R	CM	1/40
15995	Tirador 2 y 1 G5T	C/R	NS	1/40
15996	Tirador 2 y 1 G5T	C/R	NE	1/40
15997	Tirador 2 y 1 G5T	C/R	LP	1/40

Plano

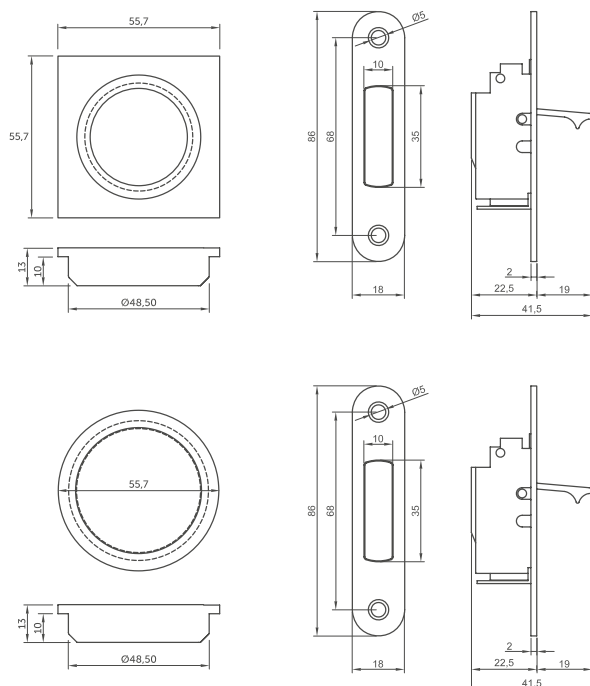

CR

Descarga la ficha técnica en www.inther.es

Kit Correderas

KIT INOX

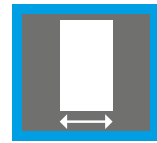

Grosor 35-40 mm.

Características técnicas

- Kit corredera en acero Inoxidable AISI 304
- Diseño minimalista.
- Productos disponible en terminación cuadrada y redonda.

Plano

Código	Descripción	Tipo	Acabado	Set
37292	Kit corredera COND 304 35/40	C/C	INOX	1/40
37291	Kit corredera COND 304 35/40	C/R	INOX	1/40

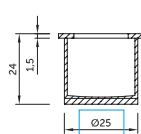
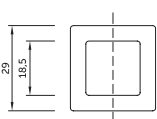
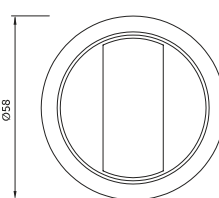
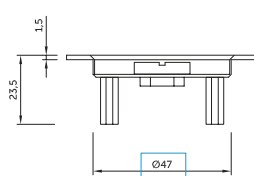
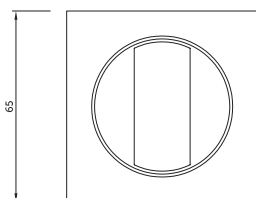
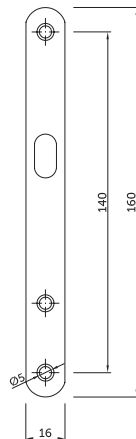
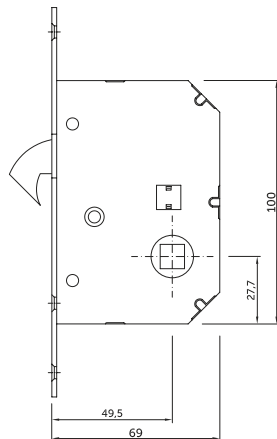
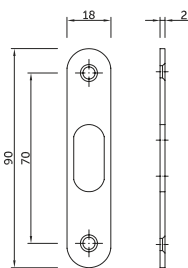

Descarga la ficha técnica en www.inther.es

Kit Correderas

KIT DESL.101/102 COND.

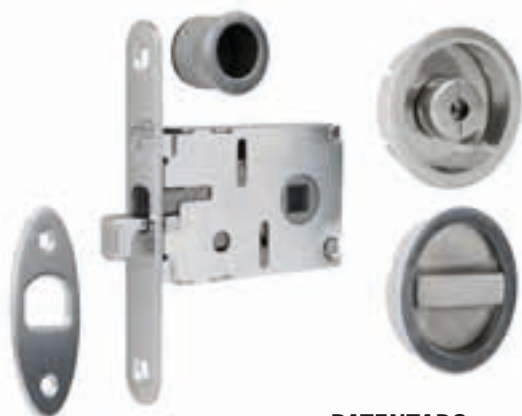

PATENTADO

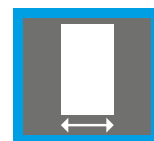

Grosor 35/45 mm.



Patentado

Características técnicas

- Diseño moderno y minimalista.
- Caja extremadamente compacta para optimizar el mecanizado.
- Alta fiabilidad y accionamiento suave.
- Incluye plantilla de montaje del cerradero y cajetín.
- Productos disponible en terminación cuadrada y redonda.

Plano

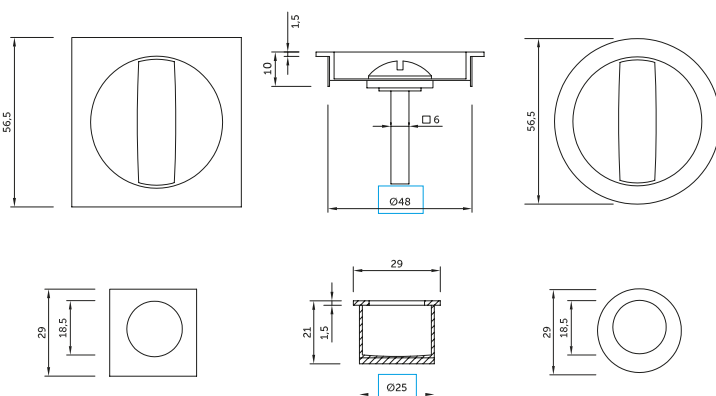
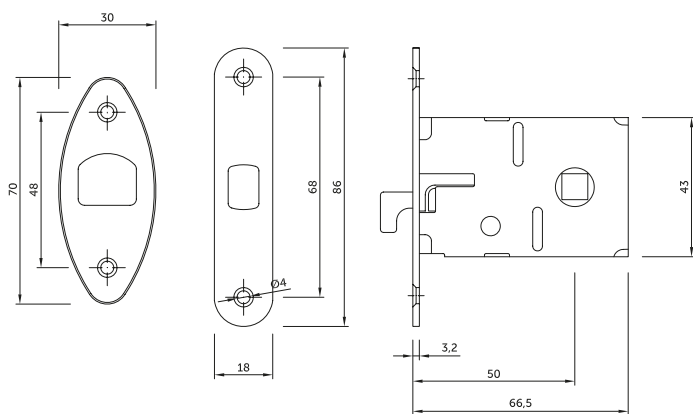
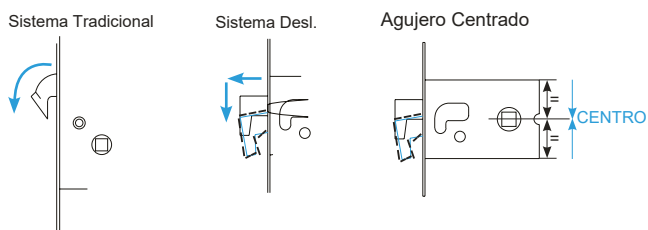

Código	Descripción	Tipo	Acabado	Set
15550	Kit Desl. 101 Cond.	C/C	NS	1/40
15552	Kit Desl. 101 Cond.	C/C	LP	1/40
15555	Kit Desl. 101 Cond.	C/C	NE	1/40
15557	Kit Desl. 101 Cond.	C/C	BL	1/40
15559	Kit Desl. 101 Cond.	C/C	LS	1/40
15561	Kit Desl. 101 Cond.	C/C	CR	1/40
15219	Kit Desl. 101 Cond.	C/C	CM	1/40
15551	Kit Desl. 102 Cond.	C/R	NS	1/40
15553	Kit Desl. 102 Cond.	C/R	LP	1/40
15554	Kit Desl. 102 Cond.	C/R	CS	1/40
15556	Kit Desl. 102 Cond.	C/R	NE	1/40
15558	Kit Desl. 102 Cond.	C/R	BL	1/40
15560	Kit Desl. 102 Cond.	C/R	LS	1/40
15562	Kit Desl. 102 Cond.	C/R	CR	1/40
15220	Kit Desl. 102 Cond.	C/R	CM	1/40



Descarga la ficha técnica en www.inther.es

Kit Correderas

KIT DESL.101/102 LLAVE



PATENTADO

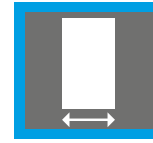

Grosor 35/45 mm.



Patentado

Características técnicas

- Diseño moderno y minimalista.
- Caja extremadamente compacta para optimizar el mecanizado.
- Alta fiabilidad y accionamiento suave.
- Incluye plantilla de montaje del cerradero y cajetin.
- Productos disponible en terminación cuadrada y redonda.

Plano

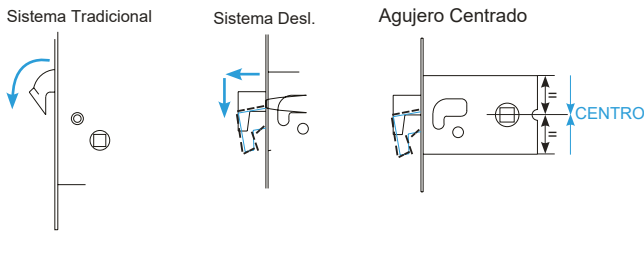

Código	Descripción	Tipo	Acabado	Set
15565	Kit Desl. 103 Llave	C/C	NS	1/40
15567	Kit Desl. 103 Llave	C/C	LP	1/40
13815	Kit Desl. 103 Llave	C/C	CM	1/40
15566	Kit Desl. 104 Llave	C/R	NS	1/40
15568	Kit Desl. 104 Llave	C/R	LP	1/40
15569	Kit Desl. 104 Llave	C/R	CS	1/40
13813	Kit Desl. 104 Llave	C/R	CM	1/40

* No incluye cilindro

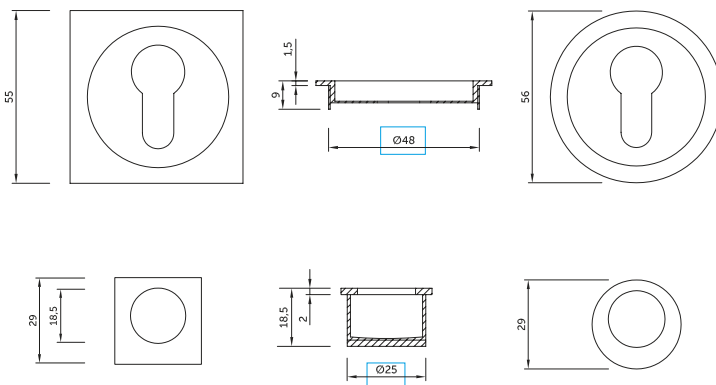
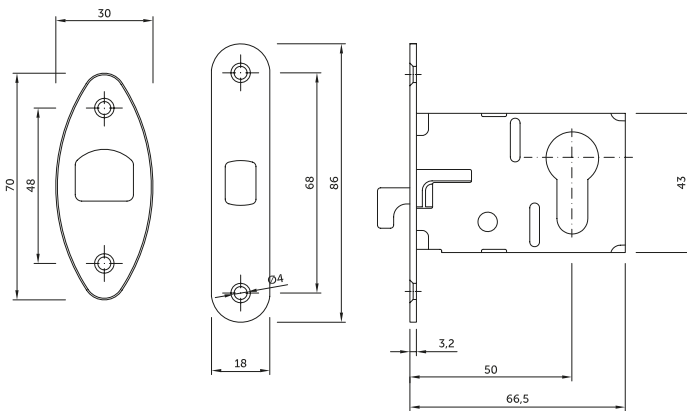

Descarga la ficha técnica en www.inther.es

Kit Correderas

KIT COND.

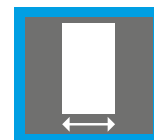

Grosor regulable
34 - 45 mm.

Características técnicas

- Kit corredera standard.
- Productos disponible en terminación cuadrada y redonda.

Código	Descripción	Tipo	Acabado	Set
CE01586	Kit corredera Cond. Cuadrada	C/C	NS	1/40
3666RNS	Kit corredera Cond. Redonda	C/R	NS	1/40
3666RCR	Kit corredera Cond. Redonda	C/R	CR	1/40
CE00368	Kit corredera Cond. Cuadrada	C/C	LP	1/40
3666RLP	Kit corredera Cond. Redonda	C/R	LP	1/40
CE01587	Kit corredera Cond. Cuadrada	C/C	LS	1/40
3666RLS	Kit corredera Cond. Redonda	C/R	LS	1/40
3666RCM	Kit corredera Cond. Redonda	C/R	CM	1/40
3666RCU	Kit corredera Cond. Redonda	C/R	CS	1/40
SVKITRNE	Kit corredera Cond. Redonda	C/R	NE	1/40

Plano

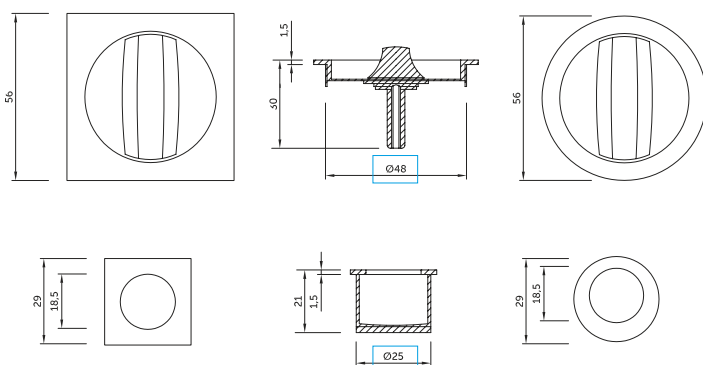
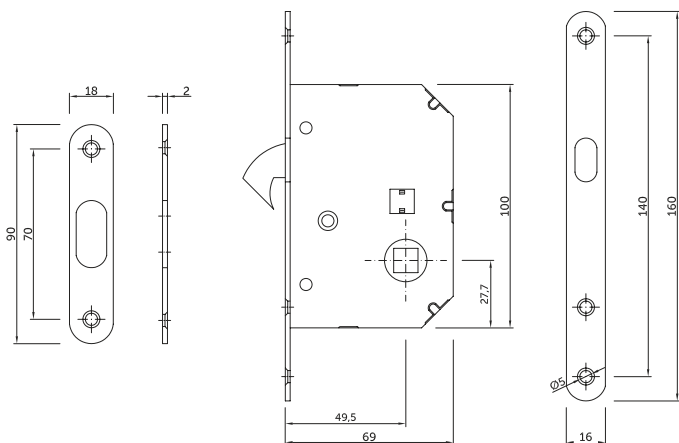
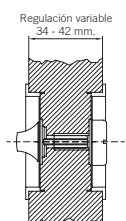

Descarga la ficha técnica en www.inther.es

Kit Correderas

KIT LLAVE

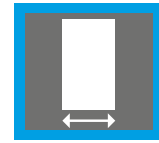

Grosor regulable
34 - 45 mm.

Características técnicas

- Kit corredera standard
- Incluye cilindro de 20x20 mm.
- Productos disponible en terminación cuadrada y redonda.

Plano

Código	Descripción	Tipo	Acabado	Set
12746	Kit corredera Llave	C/C	NS	1/40
12742	Kit corredera Llave	C/R	NS	1/40
12747	Kit corredera Llave	C/C	LP	1/40
12743	Kit corredera Llave	C/R	LP	1/40
12748	Kit corredera Llave	C/C	CM	1/40
12744	Kit corredera Llave	C/R	CM	1/40
12745	Kit corredera Llave	C/R	CS	1/40

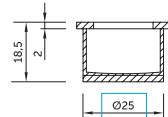
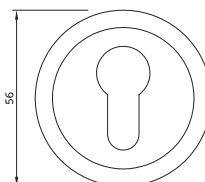
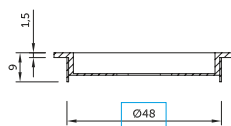
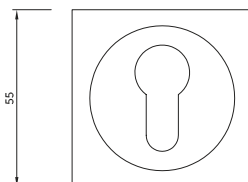
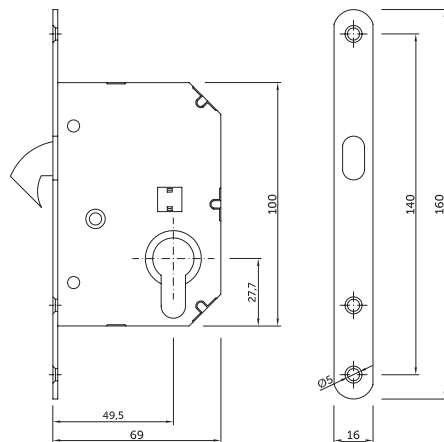
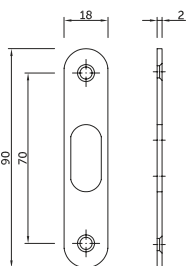

Descarga la ficha técnica en www.inther.es



Canto cuadrado (CC)

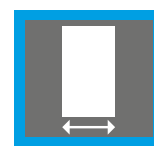

Grosor 35 >

Características técnicas

- Kit corredera standard.



Canto redondo (CR)

Canto cuadrado

Código	Descripción	Tipo	Acabado	Set
05415	Tirador 2 y 1	C/C	NS	1/40
50104	Tirador 2 y 1	C/C	CR	1/40
05378	Tirador 2 y 1	C/C	LP	1/40
05380	Tirador 2 y 1	C/C	LS	1/40
05377	Tirador 2 y 1	C/C	CM	1/40

Canto redondo

Código	Descripción	Tipo	Acabado	Set
06717	Tirador 2 y 1	C/R	NS	1/40
60110	Tirador 2 y 1 BORJA	C/R	NS	1/40
06706	Tirador 2 y 1	C/R	LP	1/40
60111	Tirador 2 y 1 BORJA	C/R	LP	1/40
06715	Tirador 2 y 1	C/R	LS	1/40
06538	Tirador 2 y 1	C/R	CM	1/40
06707	Tirador 2 y 1	C/R	CS	1/40

Plano

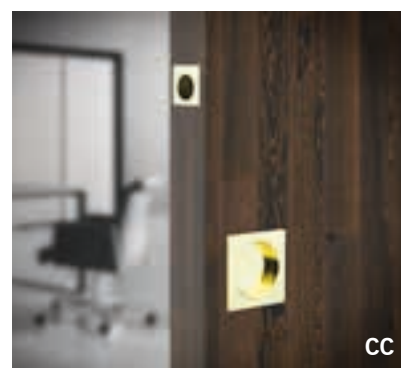
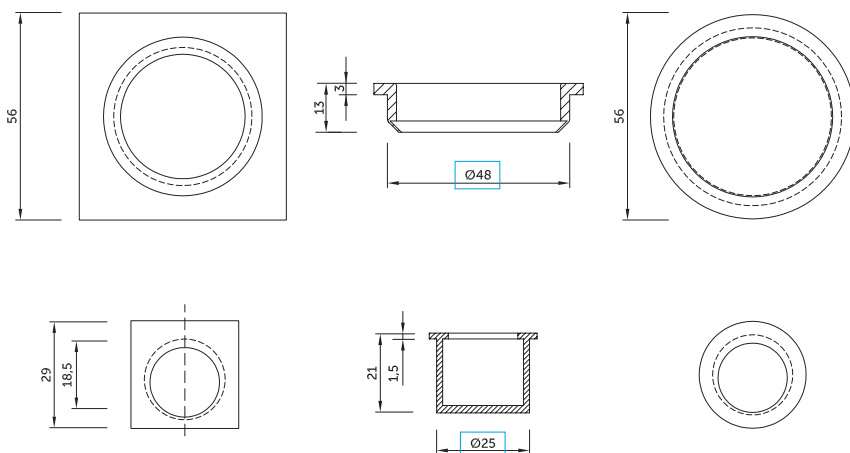

CC



CR

Descarga la ficha técnica en www.inther.es

ACCEDE A NUESTRA
TIENDA ONLINE



www.herrajesandalucia.com



www.herrajesandalucia.com

AVDA LA INDUSTRIA 15
POL.CRTA AMARILLA
C.P. 41007 Sevilla
Telf 954998540

SIERRA ATALAYA, 29
P.I.LA JUAIDA
C.P. 04240 Viator (Almería)
Telf 950306098