

Catálogo General

Catalogue Général

General Catalog

General Katalog

Herrajes para muebles / Garnitures pour meubles / Furniture fittings / Möbelbeschläge



Referencias y páginas
Références et pages
References and pages
Referenzen und Seiten

| | | | | | | | | | | | | | |
|------|-----|------|-------|------|-------------|------|-------|------|----------|------|----------|-------|-----|
| 231 | 120 | 3271 | 73 | 5625 | 103 | 7006 | 70 | 7483 | 57 | 7951 | 70 | 8810 | 68 |
| 232 | 120 | 3272 | 73 | 5626 | 103 | 7007 | 70 | 7491 | 88 | 7952 | 70 | 8820 | 68 |
| 1000 | 116 | 3281 | 64 | 5627 | 103 | 7008 | 70 | 7492 | 88 | 7953 | 70 | 8830 | 68 |
| 1001 | 116 | 3282 | 64 | 5628 | 103 | 7009 | 70 | 7501 | 71 | 7954 | 70 | 8841 | 89 |
| 1002 | 116 | 3500 | 33/65 | 5629 | 103 | 7010 | 70 | 7502 | 71 | 7991 | 67 | 8842 | 89 |
| 1003 | 116 | 3510 | 33/65 | 5981 | 40 | 7011 | 70 | 7503 | 71 | 7992 | 67 | 8851 | 58 |
| 1004 | 116 | 3511 | 33/65 | 5982 | 40 | 7012 | 70 | 7504 | 71 | 8010 | 69 | 8852 | 58 |
| 1005 | 117 | 3512 | 33/65 | 5983 | 40 | 7013 | 70 | 7505 | 71 | 8080 | 54 | 8871 | 86 |
| 1006 | 117 | 3530 | 63 | 6100 | 16/35 | 7014 | 70 | 7506 | 71 | 8090 | 56 | 8921 | 71 |
| 1007 | 117 | 3531 | 63 | 6111 | 16/35 | 7015 | 70 | 7511 | 111 | 8101 | 39 | 8922 | 71 |
| 1008 | 117 | 3532 | 63 | 6112 | 16/35 | 7016 | 70 | 7512 | 111 | 8102 | 39 | 9062 | 72 |
| 1009 | 117 | 3533 | 63 | 6130 | 79 | 7017 | 70 | 7513 | 111 | 8103 | 39 | 9063 | 72 |
| 102A | 118 | 3541 | 45 | 6131 | 79 | 7018 | 70 | 7520 | 55 | 8130 | 38 | 9090 | 41 |
| 102B | 118 | 3542 | 45 | 6132 | 79 | 7019 | 70 | 7521 | 55 | 8141 | 82 | 9381 | 41 |
| 102C | 118 | 3560 | 65 | 6141 | 82 | 7020 | 55 | 7531 | 30 | 8142 | 82 | 9382 | 41 |
| 102D | 118 | 3561 | 65 | 6142 | 82 | 7021 | 55 | 7532 | 30 | 8151 | 25/43 | 9383 | 41 |
| 102E | 118 | 3562 | 65 | 6150 | 80 | 7022 | 55 | 7541 | 38 | 8152 | 25 | 9390 | 44 |
| 1020 | 116 | 3600 | 65 | 6151 | 80 | 7023 | 55 | 7542 | 38 | 8161 | 25/32/43 | 9391 | 44 |
| 1021 | 116 | 3701 | 72 | 6152 | 80 | 7024 | 55 | 7543 | 38 | 8162 | 25/32 | 9501 | 96 |
| 1022 | 116 | 3702 | 72 | 6160 | 83 | 7025 | 55 | 7552 | 68 | 8171 | 25/32 | 9502 | 96 |
| 1023 | 116 | 3703 | 72 | 6161 | 83 | 7026 | 55 | 7553 | 68 | 8172 | 25/32 | 9531 | 96 |
| 1024 | 116 | 3710 | 48 | 6162 | 83 | 7031 | 61 | 7554 | 68 | 8191 | 87 | 9532 | 96 |
| 1025 | 117 | 3720 | 47 | 6170 | 81 | 7032 | 61 | 7561 | 84 | 8192 | 87 | 9533 | 96 |
| 1026 | 117 | 3730 | 47 | 6171 | 81 | 7051 | 66 | 7562 | 84 | 8321 | 69 | 9551 | 96 |
| 1027 | 117 | 3740 | 47 | 6190 | 18 | 7052 | 66 | 7570 | 29/34 | 8322 | 69 | 9552 | 96 |
| 1028 | 117 | 3750 | 46 | 6191 | 18 | 7061 | 67 | 7571 | 29/34 | 8323 | 69 | 9651 | 96 |
| 1029 | 117 | 3801 | 73 | 6200 | 19 | 7081 | 67 | 7572 | 29/34 | 8324 | 69 | 9652 | 96 |
| 1030 | 118 | 3802 | 73 | 6201 | 19 | 7082 | 67 | 7581 | 85 | 8351 | 69 | 9681 | 96 |
| 1101 | 114 | 3900 | 73 | 6210 | 19 | 7121 | 67 | 7582 | 85 | 8352 | 69 | 9682 | 96 |
| 1102 | 114 | 3921 | 73 | 6211 | 19 | 7122 | 67 | 7590 | 49 | 8353 | 69 | 9700 | 95 |
| 1103 | 114 | 3922 | 73 | 6231 | 15/33 | 7131 | 60 | 7610 | 71 | 8354 | 69 | 9770 | 95 |
| 1104 | 114 | 3930 | 73 | 6232 | 15/33 | 7132 | 60 | 7611 | 71 | 8361 | 71 | 9771 | 95 |
| 1105 | 114 | 3940 | 72 | 6521 | 78 | 7140 | 60 | 7612 | 71 | 8362 | 71 | 9772 | 95 |
| 1106 | 115 | 5001 | 72 | 6751 | 31 | 7150 | 43/66 | 7613 | 71 | 8363 | 71 | 9821 | 94 |
| 1107 | 115 | 5002 | 72 | 6752 | 31 | 7191 | 87 | 7614 | 71 | 8461 | 69 | 9822 | 94 |
| 1108 | 115 | 5101 | 72 | 6761 | 28/33/42/77 | 7192 | 87 | 7651 | 53 | 8462 | 69 | 9831 | 94 |
| 1109 | 115 | 5102 | 72 | 6762 | 28/33/77 | 7241 | 57 | 7652 | 53 | 8463 | 69 | 9832 | 94 |
| 1801 | 26 | 5201 | 72 | 6763 | 28/33/42/77 | 7242 | 57 | 7653 | 53 | 8471 | 69 | 9841 | 94 |
| 1802 | 26 | 5202 | 72 | 6764 | 28/33/77 | 7251 | 91 | 7661 | 35/37/77 | 8472 | 69 | 9842 | 94 |
| 1803 | 26 | 5221 | 72 | 6765 | 28/33/42/77 | 7252 | 91 | 7662 | 35/37/77 | 8473 | 69 | 9851 | 94 |
| 1810 | 26 | 5222 | 72 | 6770 | 24 | 7281 | 66 | 7663 | 35/37/77 | 8491 | 88 | 9852 | 94 |
| 1820 | 27 | 5601 | 100 | 6771 | 24 | 7282 | 66 | 7681 | 52 | 8521 | 78 | 9912 | 97 |
| 1830 | 27 | 5602 | 100 | 6772 | 24 | 7291 | 66 | 7682 | 52 | 8561 | 84 | 9913 | 97 |
| 2000 | 112 | 5603 | 100 | 6781 | 22/35/77 | 7292 | 66 | 7683 | 52 | 8562 | 84 | 9932 | 97 |
| 2101 | 109 | 5604 | 101 | 6782 | 22/35/77 | 7321 | 59 | 7684 | 52 | 8581 | 85 | 9933 | 97 |
| 2102 | 109 | 5605 | 101 | 6791 | 23/33 | 7322 | 59 | 7691 | 36 | 8651 | 91 | 9952 | 97 |
| 2111 | 108 | 5606 | 101 | 6792 | 23/33 | 7371 | 89 | 7692 | 36 | 8652 | 91 | 9953 | 97 |
| 2112 | 108 | 5607 | 101 | 6801 | 21 | 7372 | 89 | 7693 | 36 | 8653 | 91 | 9982 | 97 |
| 2201 | 109 | 5608 | 101 | 6802 | 21 | 7381 | 58 | 7694 | 36 | 8661 | 69 | 9983 | 97 |
| 2202 | 109 | 5611 | 102 | 6803 | 21 | 7382 | 58 | 7751 | 31 | 8671 | 66 | 9991 | 97 |
| 2211 | 108 | 5612 | 102 | 6811 | 20/32/42/76 | 7411 | 66 | 7810 | 71 | 8672 | 66 | 9992 | 97 |
| 2212 | 108 | 5613 | 102 | 6812 | 20/32/42/76 | 7412 | 66 | 7811 | 71 | 8673 | 66 | 9993 | 97 |
| 2810 | 113 | 5614 | 102 | 6821 | 17/34/42 | 7421 | 86 | 7812 | 71 | 8701 | 66 | ED-15 | 120 |
| 2840 | 113 | 5615 | 102 | 6822 | 17/34/42 | 7422 | 86 | 7813 | 71 | 8702 | 66 | M-45 | 119 |
| 2850 | 113 | 5616 | 102 | 6831 | 14/33/43 | 7461 | 54 | 7814 | 71 | 8711 | 67 | T-14 | 120 |
| 2860 | 113 | 5617 | 102 | 6832 | 14/33/43 | 7462 | 54 | 7830 | 90 | 8712 | 67 | T-21 | 120 |
| 2870 | 107 | 5618 | 102 | 7000 | 70 | 7463 | 54 | 7861 | 62/71 | 8721 | 67 | T-25 | 120 |
| 2880 | 106 | 5619 | 102 | 7001 | 70 | 7471 | 56/76 | 7862 | 62/71 | 8722 | 67 | T-31 | 120 |
| 3251 | 73 | 5621 | 103 | 7002 | 70 | 7472 | 56/76 | 7921 | 71 | 8731 | 67 | T-35 | 120 |
| 3252 | 73 | 5622 | 103 | 7003 | 70 | 7473 | 56/76 | 7922 | 71 | 8732 | 67 | T-40 | 120 |
| 3261 | 73 | 5623 | 103 | 7004 | 70 | 7481 | 57 | 7923 | 71 | 8790 | 69 | T-60 | 120 |
| 3262 | 73 | 5624 | 103 | 7005 | 70 | 7482 | 57 | 7950 | 70 | 8800 | 59 | | |

Información sobre las medidas

Informations sur les mesures
Information about measures
Informationen über die Maße

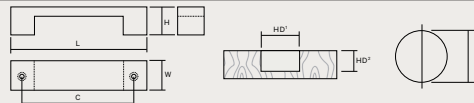

ESTAMP[®]
Quality knobs and handles

Catálogo General

Catalogue Général

General Catalog

General Katalog

Herrajes para muebles / Garnitures pour meubles / Furniture fittings / Möbelbeschläge



J. JOSÉ VERGÉS S.A.
1 9 2 8

Catálogo General

Catalogue Général

General Catalog

General Katalog

Herrajes para muebles / Garnitures pour meubles / Furniture fittings / Möbelbeschläge



Wave
P. 39



Fuji
P. 20



| | |
|---------|------------------------------------------------------------------------------------------------|
| 4-11 | Presentación <i>Présentation</i> Presentation <i>Präsentation</i> |
| 12-49 | Vanguardista <i>Avant-gardiste</i> Cutting-edge <i>Avantgardistisch</i> |
| 50-73 | Contemporáneo <i>Contemporain</i> Contemporary <i>Zeitgenössisch</i> |
| 74-91 | Rústico <i>Rustique</i> Rustic <i>Rustikal</i> |
| 92-97 | Clásico <i>Classique</i> Classic <i>Klassisch</i> |
| 98-103 | Infantil <i>Enfants</i> Children <i>Kinder</i> |
| 104-118 | Complementos <i>Compléments</i> Complements <i>Ergänzungen</i> |
| 119-120 | Accesorios <i>Accessoires</i> Accessories <i>Zubehör</i> |

90 años de continua evolución

90 ans de continue évolution

90 years in constant evolution

90 Jahre kontinuierlicher Evolution

Presentación / Présentation / Presentation / Präsentation

En Estamp cumplimos 90 años. Casi un siglo en el que hemos fabricado y vendido millones de artículos en todo el mundo.

Nada de esto hubiera sido posible sin la inestimable cooperación de todos y cada uno de nuestros colaboradores, dentro y fuera de nuestra empresa. Tampoco sin la creatividad y el acierto de nuestros diseñadores y la colaboración de nuestros proveedores. Es por eso que hoy queremos agradecer a todos ellos que nos hayan acompañado durante este largo viaje, e invitarles a que sigan haciéndolo durante muchos más.

Chez Estamp, nous avons 90 ans. Presque un siècle dans lequel nous avons fabriqué et vendu millions d'articles dans le monde entier.

Rien de cela aurait été possible sans l'inestimable coopération de tous et chacun de nos collaborateurs, dans et hors de notre entreprise. Aussi sans la créativité et le succès de nos designers et avec la collaboration de nos fournisseurs. C'est pour cela qu'aujourd'hui nous voulons remercier à tous ceux qui nous ont accompagnés pendant ce long voyage et les inviter à continuer de le faire pendant beaucoup plus.

At Estamp we celebrate our 90th birthday. Nearly a century during which we have manufactured and sold millions of articles worldwide.

This would not have been possible without the valuable co-operation of each and every one of our teammates, inside and outside our company. Nor without the creativity and the success of our designers and the co-operation of our suppliers. So today we wish to thank them all for walking beside us during this long journey, and to invite them to go on doing so for may more years to come.

Bei Estamp feiern wir 90 jähriges Jubiläum. Fast ein Jahrhundert, in dem wir Millionen Artikel hergestellt und weltweit verkauft haben.

All dies wäre nicht möglich gewesen ohne die schätzbare Zusammenarbeit mit jedem einzelnen Mitarbeiter, innerhalb und außerhalb unseres Unternehmens, und überdies der Kreativität und dem Geschick unserer Designer sowie der Beteiligung unserer Lieferanten. Deshalb möchten wir uns heute bei allen bedanken, die uns auf dieser langen Reise begleitet haben und Sie einladen, dies noch für viele weitere Jahre zu tun.



Edge
P. 30



Calidad y perfección

Qualité et perfection

Quality and perfection

Qualität und Perfektion

La calidad y perfección siempre han sido nuestra divisa y la clave de nuestro éxito, por eso la hemos hecho extensiva a todos nuestros ámbitos de actividad, tanto de producción como humanos.

La qualité et la perfection ont été toujours notre devise et la clé de notre succès, pour cela nous l'avons étendue à tous nos cadres d'activité tant en production comme humains.

Quality and perfection have always been our trademark and the key to our success. This is why we have extended them to all our areas of activity, as much in production as in human resources.

Qualität und Perfektion sind seit jeher unser Motto und der Schlüssel unseres Erfolges. Aus diesem Grund haben wir es auf alle Tätigkeitsbereiche ausgedehnt, sowohl in der Produktion als auch das Personal betreffend.

Ergonomía aplicada

Ergonomie appliquée

Applied ergonomics

Angewandte Ergonomie

En Estamp sabemos que la ergonomía es importante, y por eso nos volcamos en darles a nuestros herrajes el mejor de los diseños y una funcionalidad óptima.

Chez Estamp, nous savons que l'ergonomie est importante et par cela nous donnons à nos garnitures le meilleur des designs et une fonctionnalité optimale.

At Estamp we know how important ergonomics are, and that is why we strive to give our hardware the best of designs and optimal functionality.

Bei Estamp wissen wir, daß Ergonomie wichtig ist. Deshalb streben wir an, mit unseren Beschlägen bestes Design und optimale Funktionalität anzubieten.

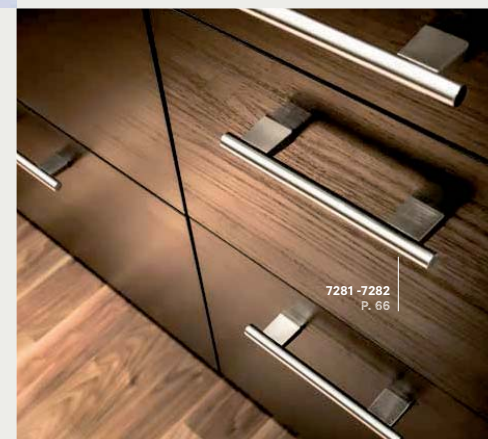

7281-7282
P. 61



J. José Vergés
Management team



7031-7032
P. 61



Nature
P. 44



Tecnología, Experiencia y Talento
Technologie, Expérience et Talent
 Technology, Expertise and Talent
 Technologie, Erfahrung und Talent

Tres elementos imprescindibles para concebir y producir más de 1.500 artículos de formas puras de alta calidad y acabados perfectos.

Trois éléments indispensables pour concevoir et produire plus de 1.500 articles de formes pures de haute qualité et de finitions parfaites.

Three essential elements to conceive and produce more than 1.500 articles in pure forms of high quality and perfect finishes.

Drei wesentliche Elemente zur Schaffung und Herstellung von mehr als 1500 Artikeln reiner Formen in hoher Qualität und mit perfekten Oberflächen.



Proceso Productivo
Procès productif
 Production process
 Produktionsprozess



El medio ambiente: nuestro compromiso
L'environnement : notre objectif
 Environment is our aim
 Umweltschutz: unser Ziel

Expertos en fabricar con la mejor calidad y el máximo respeto al medioambiente.

Experts dans la fabrication avec la plus haute qualité et maximum de respect pour l'environnement.

Experts in manufacturing with the highest quality and maximum respect for the environment.

Experten bei der Herstellung in hochwertiger Qualität und maximalem Respekt für die Umwelt.



Un mundo de posibilidades

Un monde de possibilités

A world of possibilities

Eine Vielfalt an Möglichkeiten

Presentación / Présentation / Presentation / Präsentation

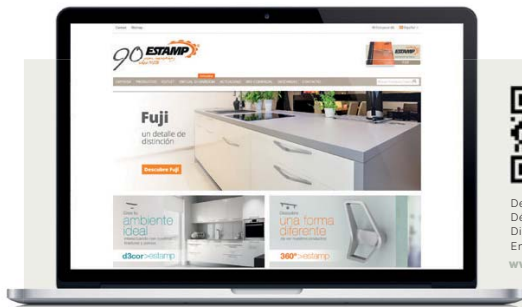

Descubra las últimas novedades
 Découvrez les dernières nouvelles
 Discover the latest news
 Entdecken Sie die neuesten Nachrichten
www.verges.com



Marketing y Merchandising

Marketing et Merchandising

Marketing and Merchandising

Marketing und Merchandising

En Estamp disponemos de un amplio equipo profesional dedicado al trato con el distribuidor para asesorarle de las mejores opciones comerciales para su punto de venta. Ponemos a su alcance una amplia variedad de herramientas que le ayudarán a conocer y, a la vez, dar a conocer mejor nuestros productos.

Chez Estamp, nous disposons d'une large équipe professionnelle dédiée au traitement avec le distributeur pour leur conseiller les meilleures options commerciales pour leur point de vente. Nous avons à leur disposition une vaste variété d'outils qui lui aideront à connaître et en même temps, donner à connaître mieux nos produits.

At Estamp we have a large professional team dedicated to deal with the distributor, to advise them of the best commercial options for their point of sale. We put at their disposal a wide variety of tools that will help you to know our product and, at the same time, make it better known.

Bei Estamp haben wir ein vielgestaltiges Team, das mit den Vertreibern in Verbindung steht. Es berät sie über die beste kommerzielle Option für Ihre Verkaufsabteilung. Ihnen steht eine breitgefächerte Vielfalt an Instrumenten zur Verfügung, die Ihnen helfen, unsere Produkte besser kennen zu lernen und gleichzeitig bekannter zu machen.



Síguenos en Facebook.
 Suivez nous sur Facebook.
 Follow us on Facebook.
 Finde uns auf Facebook.

www.facebook.com/jjosevergesa.estamp



La sencillez de las formas

La simplicité des formes

The simplicity of forms

Die Einfachheit der Formen

Presentación / Présentation / Presentation / Präsentation

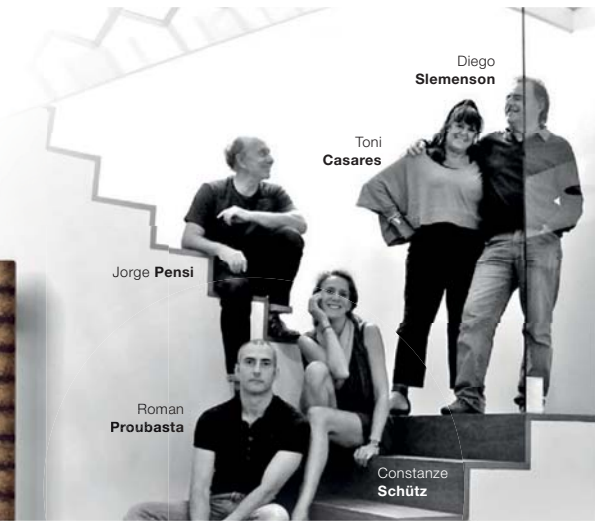

| | | | | | |
|------------------------------|-----------------------------------|------------------------------|-----------------------------|----------------------------------|------------------------------|
| Rivet Alexis Vivet | ProFlex Josep J. Teruel | Ways Jorge Navarro | Tube Alexis Vivet | ProFab Josep J. Teruel | Cell Jorge Navarro |
|------------------------------|-----------------------------------|------------------------------|-----------------------------|----------------------------------|------------------------------|

Diseñadores
Designers
Designers
Designer



Post
Alexis Vivet

Creando tendencias *En créant des tendances* Creating trends *Trends setzen*

Afamados y experimentados diseñadores, innovan día a día para crear piezas únicas y nuevas colecciones.
Renommés et expérimentés designers innovent jour à jour pour créer de pièces uniques et de nouvelles collections.
Renowned and experienced designers innovate every day to create unique pieces and new collections.
Renommierte und erfahrene Designer innovieren Tag für Tag, um einzigartige Stücke und neue Kollektionen zu kreieren.



Circle
Jorge Pensi Design Studio

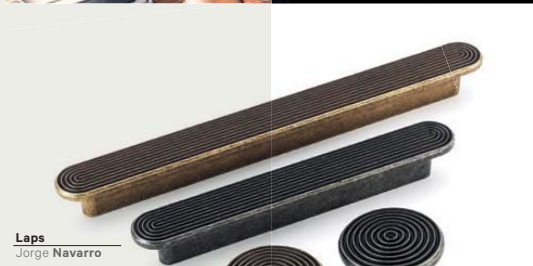

Laps
Jorge Navarro

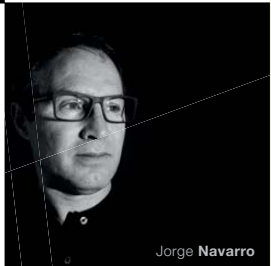

Jorge Navarro



Josep J. Teruel



ProFit
Josep J. Teruel



Vanguardista

Avant-gardiste

Cutting-edge

Avantgardistisch

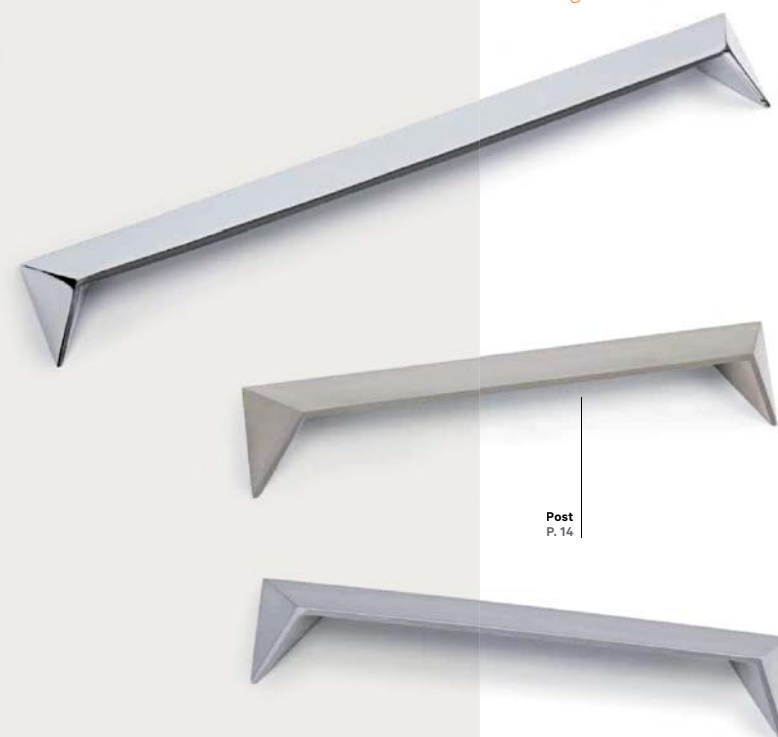

Post
P. 14

Vanguardista / Avant-gardiste / Cutting-edge / Avantgardistisch

Post 6831-6832

zamak / zamak / zamak / Zamak

| | C | L | W | H | D |
|---------|-----|-----|----|----|---|
| 6831--- | 192 | 213 | 31 | 20 | |
| 6832--- | 128 | 149 | 31 | 20 | |

acabado / finition / finish / Oberfläche

---038 ---400 ---800

ver más / voir plus / see more / siehe mehr

Black & White Collection / P. 33

Graphite & Dull Gold Collection / P. 43

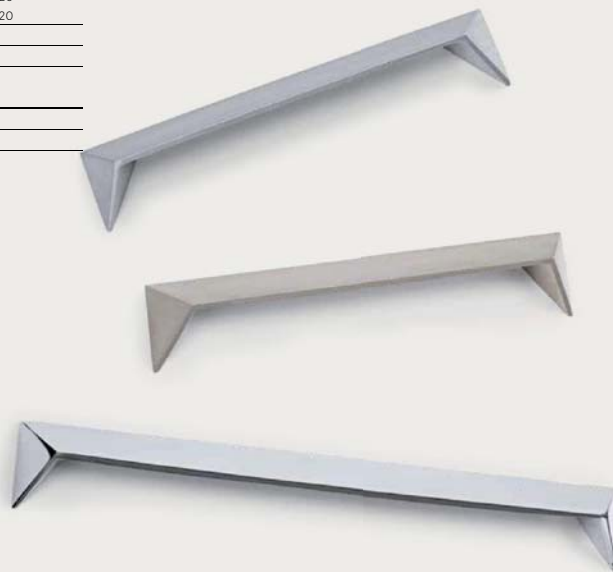

Vanguardista / Avant-gardiste / Cutting-edge / Avantgardistisch

Elbow 6231-6232

zamak / zamak / zamak / Zamak

| | C | L | W | H | D |
|---------|-----|-----|----|----|---|
| 6231--- | 192 | 208 | 20 | 30 | |
| 6232--- | 128 | 144 | 20 | 30 | |

acabado / finition / finish / Oberfläche

---038

ver más / voir plus / see more / siehe mehr

Black & White Collection / P. 33



Vanguardista / Avant-gardiste / Cutting-edge / Avantgardistisch

Circle 6111-6112

zamak / zamak / zamak / Zamak

| | C | L | W | H | D |
|---------|----|----|----|----|---|
| 6111--- | 32 | 40 | 8 | 40 | |
| 6112--- | 25 | 8 | 27 | | |

acabado / finition / finish / Oberfläche

---038 ---400 ---800

ver más / voir plus / see more / siehe mehr

Black & White Collection / P. 35



Circle 6100

zamak / zamak / zamak / Zamak

| | C | L | W | H | D |
|---------|----|----|----|----|---|
| 6100--- | 32 | 40 | 11 | 28 | |

acabado / finition / finish / Oberfläche

---038 ---400 ---800

ver más / voir plus / see more / siehe mehr

Black & White Collection / P. 35



Vanguardista / Avant-gardiste / Cutting-edge / Avantgardistisch



Fluid 6821-6822

zamak / zamak / zamak / Zamak

| | C | L | W | H | D |
|---------|---------|-----|------------|-------|---|
| 6821--- | 320/288 | 363 | 7,60/12,80 | 33,80 | |
| 6822--- | 224/192 | 236 | 7,60/12,80 | 28,80 | |

acabado / finition / finish / Oberfläche

---038 ---400 ---800

ver más / voir plus / see more / siehe mehr

Black & White Collection / P. 34

Graphite & Dull Gold Collection / P. 42



Flexo 6191

| | | | | | |
|------------------------------------------|-----|-----|----|----|---|
| zamac / zamak / zamak / Zamak | | | | | |
| | C | L | W | H | D |
| 6191--- | 160 | 186 | 24 | 29 | |
| acabado / finition / finish / Oberfläche | | | | | |
| ----811 ----812 | | | | | |



Flexo 6190

| | | | | | |
|------------------------------------------|----|----|----|---|---|
| zamac / zamak / zamak / Zamak | | | | | |
| | C | L | W | H | D |
| 6190--- | 49 | 24 | 25 | | |
| acabado / finition / finish / Oberfläche | | | | | |
| ----811 ----812 | | | | | |



Tube 6201

| | | | | | |
|------------------------------------------|-----|-----|----|----|---|
| zamac / zamak / zamak / Zamak | | | | | |
| | C | L | W | H | D |
| 6201--- | 192 | 212 | 14 | 34 | |
| acabado / finition / finish / Oberfläche | | | | | |
| ----831 ----836 | | | | | |



Tube 6200

| | | | | | |
|------------------------------------------|---|---|---|----|----|
| zamac / zamak / zamak / Zamak | | | | | |
| | C | L | W | H | D |
| 6200--- | | | | 33 | 19 |
| acabado / finition / finish / Oberfläche | | | | | |
| ----831 ----836 | | | | | |



Rivet 6211

| | | | | | |
|------------------------------------------|-----|-----|----|----|---|
| zamac / zamak / zamak / Zamak | | | | | |
| | C | L | W | H | D |
| 6211--- | 160 | 186 | 22 | 28 | |
| acabado / finition / finish / Oberfläche | | | | | |
| ----811 ----812 | | | | | |



Rivet 6210

| | | | | | |
|------------------------------------------|---|----|----|----|---|
| zamac / zamak / zamak / Zamak | | | | | |
| | C | L | W | H | D |
| 6210--- | | 56 | 20 | 30 | |
| acabado / finition / finish / Oberfläche | | | | | |
| ----811 ----812 | | | | | |



INDUSTRIAL
COLLECTION

QUALITY IN EVOLUTION



Vanguardista / Avant-gardiste / Cutting-edge / Avantgardistisch

Fuji 6811-6812

zamak / zamak / zamak / Zamak

| | C | L | W | H | D |
|---------|-----|-----|----|----|---|
| 6811--- | 224 | 320 | 20 | 32 | |
| 6812--- | 160 | 230 | 20 | 32 | |

acabado / finition / finish / Oberfläche

----038 ----400 ----800

ver más / voir plus / see more / siehe mehr

Black & White Collection / P. 32

Graphite & Dull Gold Collection / P. 42

Neo Rustik Collection / P. 76



Vanguardista / Avant-gardiste / Cutting-edge / Avantgardistisch

Scoop 6801-6803

zamak / zamak / zamak / Zamak

| | C | L | H | W | D |
|---------|-----|-----|------|---|---|
| 6801--- | 224 | 320 | 45,5 | | |
| 6802--- | 160 | 240 | 45,5 | | |
| 6803--- | 32 | 72 | 45,5 | | |

acabado / finition / finish / Oberfläche

----038 ----400 ----800



Grosor máximo frontal cajón: 22 mm
 Grosseur maximale frontal tirair: 22 mm
 Maximum width drawer front: 22 mm
 Dicke maximal front schublade: 22 mm



Vanguardista / Avant-gardiste / Cutting-edge / Avantgardistisch



Lips 6781-6782

zamak / zamak / zamak / Zamak

| | C | L | W | H | D |
|---------|-----|-----|----|---|---|
| 6781--- | 224 | 320 | 45 | | |
| 6782--- | 160 | 240 | 45 | | |

acabado / finition / finish / Oberfläche

----038 ----400 ----800

ver más / voir plus / see more / siehe mehr

Black & White Collection / P. 35

Neo Rustik Collection / P. 77

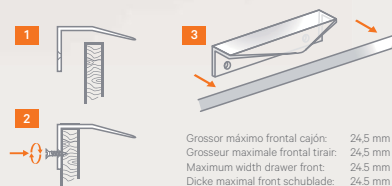

Grosor máximo frontal cajón: 24,5 mm
 Grosseur maximale frontal tirair: 24,5 mm
 Maximum width drawer front: 24,5 mm
 Dicke maximal front schublade: 24,5 mm



Vanguardista / Avant-gardiste / Cutting-edge / Avantgardistisch

Arch 6791-6792

zamak / zamak / zamak / Zamak

| | C | L | W | H | D |
|---------|-----|-----|----|---|---|
| 6791--- | 192 | 270 | 20 | | |
| 6792--- | 128 | 206 | 20 | | |

acabado / finition / finish / Oberfläche

----038 ----800

ver más / voir plus / see more / siehe mehr

Black & White Collection / P. 33





Angle 6770

zamak / zamak / zamak / Zamak

| | C | L | W | H | D |
|------------------------------------------|-----|-----|-----|-----|---|
| 6770--- | 224 | 245 | 37 | 21 | |
| acabado / finition / finish / Oberfläche | | | | | |
| ---- | 021 | 038 | 400 | 800 | |

Angle 6771

zamak / zamak / zamak / Zamak

| | C | L | W | H | D |
|------------------------------------------|-----|-----|-----|-----|---|
| 6771--- | 192 | 213 | 37 | 21 | |
| acabado / finition / finish / Oberfläche | | | | | |
| ---- | 021 | 038 | 400 | 800 | |

Angle 6772

zamak / zamak / zamak / Zamak

| | C | L | W | H | D |
|------------------------------------------|-----|-----|-----|-----|---|
| 6772--- | 192 | 213 | 37 | 21 | |
| acabado / finition / finish / Oberfläche | | | | | |
| ---- | 021 | 038 | 400 | 800 | |



Mini 8151-8152

zamak / zamak / zamak / Zamak

| | C | L | W | H | D |
|------------------------------------------|-----|-----|-----|-----|---|
| 8151--- | | 25 | 25 | 28 | |
| 8152--- | | 15 | 15 | 24 | |
| acabado / finition / finish / Oberfläche | | | | | |
| ---- | 021 | 038 | 400 | 800 | |

ver más / voir plus / see more / siehe mehr

Graphite & Dull Gold Collection / P. 43



Mini 8161-8162

zamak / zamak / zamak / Zamak

| | C | L | W | H | D |
|------------------------------------------|-----|-----|-----|-----|----|
| 8161--- | | | | 28 | 25 |
| 8162--- | | | | 24 | 15 |
| acabado / finition / finish / Oberfläche | | | | | |
| ---- | 021 | 038 | 400 | 800 | |

ver más / voir plus / see more / siehe mehr

Black & White Collection / P. 32

Graphite & Dull Gold Collection / P. 43

Mini 8171-8172

zamak / zamak / zamak / Zamak

| | C | L | W | H | D |
|------------------------------------------|-----|-----|-----|-----|---|
| 8171--- | | 34 | 14 | 28 | |
| 8172--- | | 27 | 11 | 24 | |
| acabado / finition / finish / Oberfläche | | | | | |
| ---- | 021 | 038 | 400 | 800 | |

ver más / voir plus / see more / siehe mehr

Black & White Collection / P. 32



Vanguardista / Avant-gardiste / Cutting-edge / Avantgardistisch

Vanguardista / Avant-gardiste / Cutting-edge / Avantgardistisch

ProFit 1801-1803

aluminio / aluminium / aluminium / Aluminium

| | C | L | W | H | D |
|---------|---------|-----|----|----|---|
| 1801--- | 288/320 | 341 | 10 | 31 | |
| 1802--- | 192/224 | 245 | 10 | 31 | |
| 1803--- | 128/160 | 180 | 10 | 31 | |

acabado / finition / finish / Oberfläche

----038 ----800

ProFlex 1810

aluminio / aluminium / aluminium / Aluminium

| | C | L | W | H | D |
|---------|---------|-----|-------|----|---|
| 1810--- | 192/224 | 247 | 26/10 | 32 | |

acabado / finition / finish / Oberfläche

----038 ----800

ProFlat 1820

aluminio / aluminium / aluminium / Aluminium

| | C | L | W | H | D |
|---------|---------|-----|-------|----|---|
| 1820--- | 192/224 | 247 | 24/10 | 32 | |

acabado / finition / finish / Oberfläche

----038 ----800

ProFab 1830

aluminio / aluminium / aluminium / Aluminium

| | C | L | W | H | D |
|---------|---------|-----|-------|----|---|
| 1830--- | 192/224 | 247 | 20/11 | 31 | |

acabado / finition / finish / Oberfläche

----038 ----800

PROFESSIONAL
COLLECTION

QUALITY IN EVOLUTION

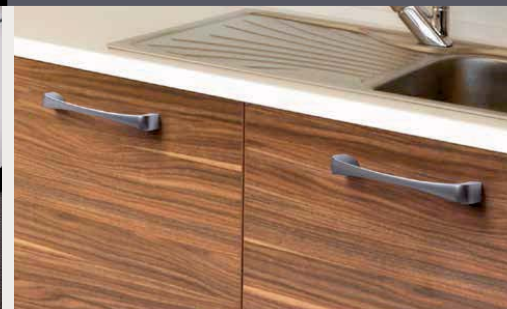

Vanguardista / Avant-gardiste / Cutting-edge / Avantgardistisch

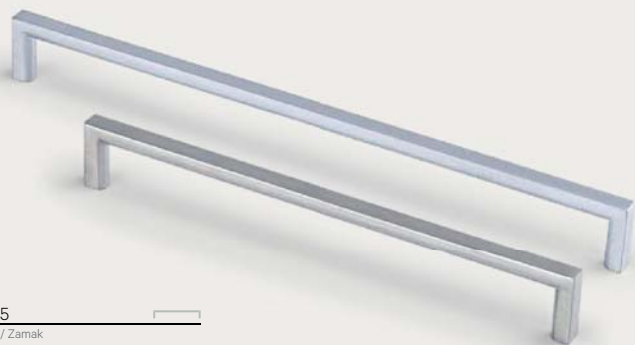

Basic 6761-6765

zamak / zamak / zamak / Zamak

| | C | L | W | H | D |
|---------|-----|-----|---|----|---|
| 6761--- | 320 | 328 | 8 | 28 | |
| 6762--- | 256 | 264 | 8 | 28 | |
| 6763--- | 192 | 200 | 8 | 28 | |
| 6764--- | 160 | 168 | 8 | 28 | |
| 6765--- | 128 | 136 | 8 | 28 | |

zamak / zamak / zamak / Zamak

---038 ---800

ver más / voir plus / see more / siehe mehr

Black & White Collection / P. 33

Graphite & Dull Gold Collection / P. 42

Neo Rustik Collection / P. 77

Vanguardista / Avant-gardiste / Cutting-edge / Avantgardistisch

I-spazio 7570

zamak / zamak / zamak / Zamak

| | C | L | W | H | D | a | b | c |
|---------|-----|-----|---|----|---|----|-----|-----|
| 7570--- | 192 | 260 | 8 | 32 | | 22 | 108 | 130 |

I-spazio 7571-7572

zamak / zamak / zamak / Zamak

| | C | L | W | H | D | a | b | c |
|---------|-----|-----|---|----|---|----|-----|----|
| 7571--- | 192 | 260 | 8 | 32 | | 76 | 108 | 76 |
| 7572--- | 128 | 200 | 8 | 32 | | 56 | 88 | 56 |

acabado / finition / finish / Oberfläche

---021 ---038 ---400 ---800

ver más / voir plus / see more / siehe mehr

Black & White Collection / P. 34

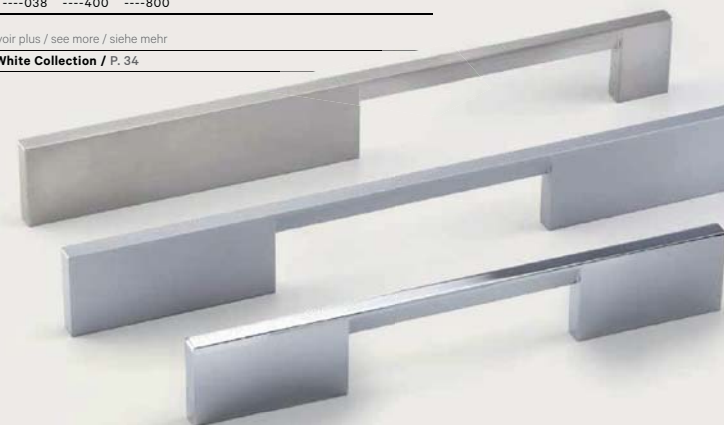

Vanguardista / Avant-gardiste / Cutting-edge / Avantgardistisch

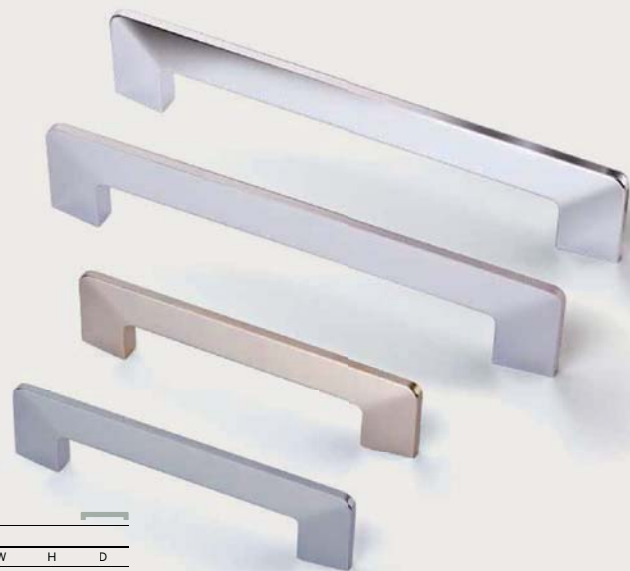

Edge 7531-7532

zamak / zamak / zamak / Zamak

| | C | L | W | H | D |
|---------|-----|-----|---|----|---|
| 7531--- | 160 | 188 | 9 | 35 | |
| 7532--- | 96 | 124 | 8 | 30 | |

acabado / finition / finish / Oberfläche

----021 ----038 ----400 ----800



Vanguardista / Avant-gardiste / Cutting-edge / Avantgardistisch

Jazz 6751-6752-7751

zamak / zamak / zamak / Zamak

| | C | L | W | H | D |
|---------|-----|-----|----|----|---|
| 6751--- | 288 | 332 | 25 | 29 | |
| 6752--- | 224 | 268 | 25 | 29 | |
| 7751--- | 160 | 204 | 25 | 29 | |

acabado / finition / finish / Oberfläche

----021 ----038 ----400 ----800



QUALITY IN EVOLUTION

BLACK & WHITE

COLLECTION

Mini 8161-8162

zamak / zamak / zamak / Zamak

| | C | L | W | H | D |
|------------------------------------------|---|---|---|----|----|
| 8161--- | | | | 28 | 25 |
| 8162--- | | | | 24 | 15 |
| acabado / finition / finish / Oberfläche | | | | | |
| ----032 ----292 | | | | | |

ver más / voir plus / see more / siehe mehr

Graphite & Dull Gold Collection / P. 43

P. 25



Mini 8171-8172

zamak / zamak / zamak / Zamak

| | C | L | W | H | D |
|------------------------------------------|---|----|----|----|---|
| 8171--- | | 34 | 14 | 28 | |
| 8172--- | | 27 | 11 | 24 | |
| acabado / finition / finish / Oberfläche | | | | | |
| ----032 ----292 | | | | | |

ver más / voir plus / see more / siehe mehr

P. 25

Fuji 6811-6812

zamak / zamak / zamak / Zamak

| | C | L | W | H | D |
|------------------------------------------|-----|-----|----|----|---|
| 6811--- | 224 | 320 | 20 | 32 | |
| 6812--- | 160 | 230 | 20 | 32 | |
| acabado / finition / finish / Oberfläche | | | | | |
| ----032 ----292 | | | | | |

ver más / voir plus / see more / siehe mehr

Graphite & Dull Gold Collection / P. 42

Neo Rustik Collection / P. 76

P. 20



Post 6831-6832

zamak / zamak / zamak / Zamak

| | C | L | W | H | D |
|------------------------------------------|-----|-----|----|----|---|
| 6831--- | 192 | 213 | 31 | 20 | |
| 6832--- | 128 | 149 | 31 | 20 | |
| acabado / finition / finish / Oberfläche | | | | | |
| ----032 ----292 | | | | | |

ver más / voir plus / see more / siehe mehr

Graphite & Dull Gold Collection / P. 43

P. 14



Stylus 3500-3512

zamak / zamak / zamak / Zamak

| | C | L | D | HD ¹ | HD ² |
|------------------------------------------|---|---|----|-----------------|-----------------|
| 3500--- | | | 65 | 60 | 11 |
| 3510--- | | | 49 | 45 | 11 |
| 3511--- | | | 40 | 35 | 11 |
| 3512--- | | | 30 | 26 | 11 |
| acabado / finition / finish / Oberfläche | | | | | |
| ----032 ----292 | | | | | |

ver más / voir plus / see more / siehe mehr

P. 65

Vanguardista / Avant-gardiste / Cutting-edge / Avantgardistisch

Basic 6761-6765

zamak / zamak / zamak / Zamak

| | C | L | W | H | D |
|-------------------------------|-----|-----|---|----|---|
| 6761--- | 320 | 328 | 8 | 28 | |
| 6762--- | 256 | 264 | 8 | 28 | |
| 6763--- | 192 | 200 | 8 | 28 | |
| 6764--- | 160 | 168 | 8 | 28 | |
| 6765--- | 128 | 136 | 8 | 28 | |
| zamak / zamak / zamak / Zamak | | | | | |
| ----032 ----292 | | | | | |

ver más / voir plus / see more / siehe mehr

Graphite & Dull Gold Collection / P. 42

Neo Rustik Collection / P. 77

P. 28

Elbow 6231-6232

zamak / zamak / zamak / Zamak

| | C | L | W | H | D |
|------------------------------------------|-----|-----|----|----|---|
| 6231--- | 192 | 208 | 20 | 30 | |
| 6232--- | 128 | 144 | 20 | 30 | |
| acabado / finition / finish / Oberfläche | | | | | |
| ----032 ----292 | | | | | |

ver más / voir plus / see more / siehe mehr

P. 15

Arch 6791-6792

zamak / zamak / zamak / Zamak

| | C | L | W | H | D |
|------------------------------------------|-----|-----|----|---|---|
| 6791--- | 192 | 320 | 20 | | |
| 6792--- | 128 | 240 | 20 | | |
| acabado / finition / finish / Oberfläche | | | | | |
| ----032 ----292 | | | | | |

ver más / voir plus / see more / siehe mehr

P. 23



I-spazio 7570

| zamac / zamak / zamak / Zamak | | | | | | | | |
|-------------------------------|-----|-----|---|----|---|----|-----|-----|
| | C | L | W | H | D | a | b | c |
| 7570--- | 192 | 260 | 8 | 32 | | 22 | 108 | 130 |

I-spazio 7571-7572

| zamac / zamak / zamak / Zamak | | | | | | | | |
|-------------------------------|-----|-----|---|----|---|----|-----|----|
| | C | L | W | H | D | a | b | c |
| 7571--- | 192 | 260 | 8 | 32 | | 76 | 108 | 76 |
| 7572--- | 128 | 200 | 8 | 32 | | 56 | 88 | 56 |

acabado / finition / finish / Oberfläche

----032 ----292

ver más / voir plus / see more / siehe mehr

P. 29

Fluid 6821-6822

| zamac / zamak / zamak / Zamak | | | | | |
|-------------------------------|---------|-----|------------|-------|---|
| | C | L | W | H | D |
| 6821--- | 320/288 | 363 | 7,60/12,80 | 33,80 | |
| 6822--- | 224/192 | 263 | 7,60/12,80 | 28,80 | |

acabado / finition / finish / Oberfläche

----032 ----292

ver más / voir plus / see more / siehe mehr

Graphite & Dull Gold Collection / P. 42

P. 17

Synthesis 7661-7663

| zamac / zamak / zamak / Zamak | | | | | |
|-------------------------------|-----|-----|----|----|---|
| | C | L | W | H | D |
| 7661--- | 192 | 230 | 44 | 24 | |
| 7662--- | 96 | 135 | 44 | 24 | |
| 7663--- | 32 | 71 | 44 | 24 | |

acabado / finition / finish / Oberfläche

----032 ----292

ver más / voir plus / see more / siehe mehr

Neo Rustik Collection / P. 77

P. 37

Circle 6100

| zamac / zamak / zamak / Zamak | | | | | |
|-------------------------------|----|----|----|----|---|
| | C | L | W | H | D |
| 6100--- | 32 | 40 | 11 | 28 | |

acabado / finition / finish / Oberfläche

----032 ----292

ver más / voir plus / see more / siehe mehr

P. 16

Circle 6111-6112

| zamac / zamak / zamak / Zamak | | | | | |
|-------------------------------|----|----|---|----|---|
| | C | L | W | H | D |
| 6111--- | 32 | 40 | 8 | 40 | |
| 6112--- | | 25 | 8 | 27 | |

acabado / finition / finish / Oberfläche

----032 ----292

ver más / voir plus / see more / siehe mehr

P. 16

Lips 6781-6782

| zamac / zamak / zamak / Zamak | | | | |
|-------------------------------|-----|-----|----|---|
| | C | L | W | D |
| 6781--- | 224 | 320 | 45 | |
| 6782--- | 160 | 240 | 45 | |

acabado / finition / finish / Oberfläche

----032 ----292

ver más / voir plus / see more / siehe mehr

Neo Rustik Collection / P. 77

P. 22

BLACK&WHITE
COLLECTION

QUALITY IN EVOLUTION



Vanguardista / Avant-gardiste / Cutting-edge / Avantgardistisch

Dual 7691-7693

zamak / zamak / zamak / Zamak

| | C | L | W | H | D |
|------------------------------------------|-----|------|-----|------|-----|
| 7691--- | 192 | 201 | 10 | 26 | |
| 7692--- | 160 | 169 | 10 | 26 | |
| 7693--- | 128 | 137 | 10 | 26 | |
| acabado / finition / finish / Oberfläche | | | | | |
| ---- | 038 | ---- | 400 | ---- | 800 |



Dual 7694

zamak / zamak / zamak / Zamak

| | C | L | W | H | D |
|------------------------------------------|-----|------|-----|------|-----|
| 7694--- | 16 | 26 | 10 | 26 | |
| acabado / finition / finish / Oberfläche | | | | | |
| ---- | 038 | ---- | 400 | ---- | 800 |



Vanguardista / Avant-gardiste / Cutting-edge / Avantgardistisch

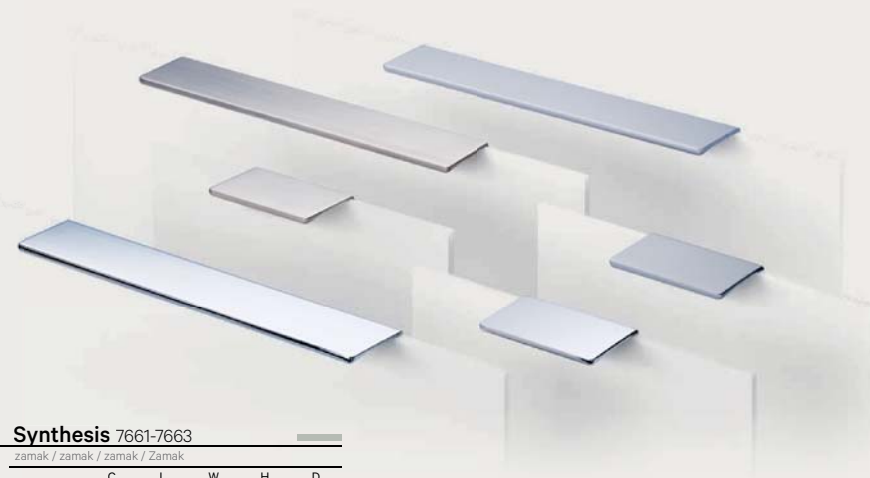

Synthesis 7661-7663

zamak / zamak / zamak / Zamak

| | C | L | W | H | D |
|------------------------------------------|-----|------|-----|------|-----|
| 7661--- | 192 | 230 | 44 | 24 | |
| 7662--- | 96 | 135 | 44 | 24 | |
| 7663--- | 32 | 71 | 44 | 24 | |
| acabado / finition / finish / Oberfläche | | | | | |
| ---- | 021 | ---- | 038 | ---- | 400 |

ver más / voir plus / see more / siehe mehr

Black & White Collection / P. 35

Neo Rustik Collection / P. 77



Align 7541-7543

zamak / zamak / zamak / Zamak

| | C | L | W | H | D |
|---------|-----|-----|---|---|---|
| 7541--- | 224 | 252 | 9 | | |
| 7542--- | 192 | 208 | 9 | | |
| 7543--- | 128 | 157 | 9 | | |

acabado / finition / finish / Oberfläche

----021 ----038 ----400 ----800

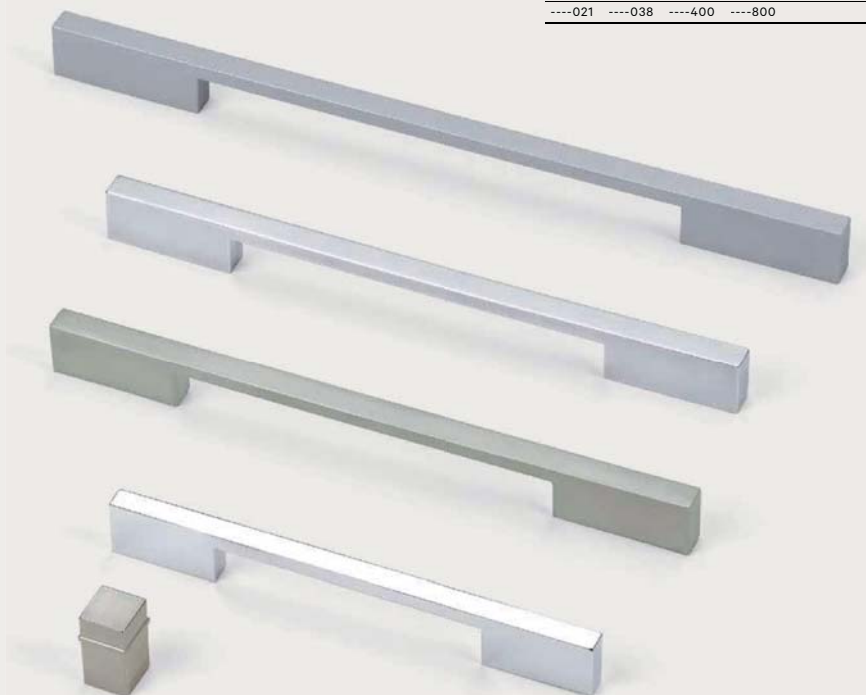

Align 8130

zamak / zamak / zamak / Zamak

| | C | L | W | H | D |
|---------|---|----|----|---|---|
| 8130--- | | 15 | 15 | | |

acabado / finition / finish / Oberfläche

----038 ----400 ----800

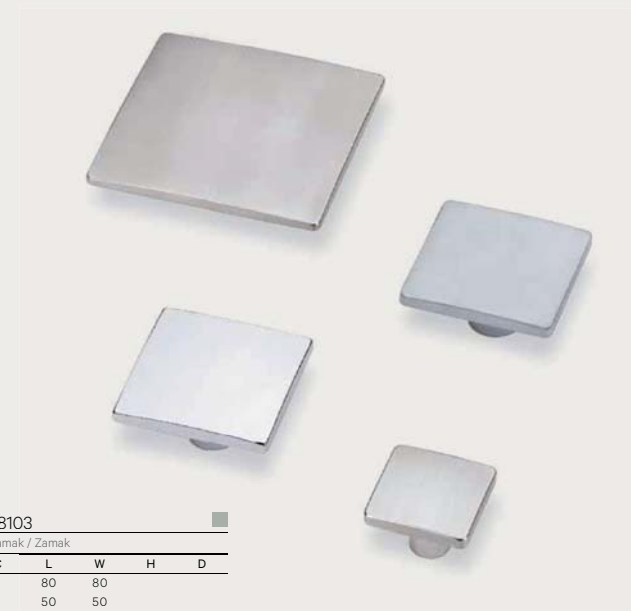

Wave 8101-8103

zamak / zamak / zamak / Zamak

| | C | L | W | H | D |
|---------|---|----|----|---|---|
| 8101--- | | 80 | 80 | | |
| 8102--- | | 50 | 50 | | |
| 8103--- | | 32 | 32 | | |

acabado / finition / finish / Oberfläche

----021 ----038 ----400 ----800



Vanguardista / Avant-gardiste / Cutting-edge / Avantgardistisch

Acrylic 5981-5982

metacrilato-zamak / methacrylate-zamak / methacrylate-zamak / Methacrylat-Zamak

| | C | L | W | H | D |
|------------------------------------------|---------|------|-----|------|-----|
| 5981--- | 192-160 | 240 | 28 | 27 | |
| 5982--- | 128-96 | 175 | 28 | 27 | |
| acabado / finition / finish / Oberfläche | | | | | |
| ---- | 302 | ---- | 333 | ---- | 369 |

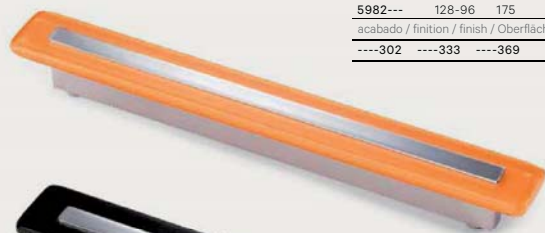

Acrylic 5983

metacrilato-zamak / methacrylate-zamak / methacrylate-zamak / Methacrylat-Zamak

| | C | L | W | H | D |
|------------------------------------------|-----|------|-----|------|-----|
| 5983--- | 16 | 65 | 28 | 27 | |
| acabado / finition / finish / Oberfläche | | | | | |
| ---- | 302 | ---- | 333 | ---- | 369 |



Vanguardista / Avant-gardiste / Cutting-edge / Avantgardistisch

Symbiosis 9381-9383

madera-zamak / bois-zamak / wood-zamak / Holz-Zamak

| | C | L | W | H | D |
|------------------------------------------|-----|------|-----|------|---|
| 9381--- | 192 | 208 | 12 | 29 | |
| 9382--- | 160 | 176 | 12 | 29 | |
| 9383--- | 128 | 144 | 12 | 29 | |
| acabado / finition / finish / Oberfläche | | | | | |
| ---- | 800 | ---- | 815 | ---- | |



Symbiosis 9090

madera-zamak / bois-zamak / wood-zamak / Holz-Zamak

| | C | L | W | H | D |
|------------------------------------------|-----|------|-----|------|---|
| 9090--- | | 21 | 21 | 29 | |
| acabado / finition / finish / Oberfläche | | | | | |
| ---- | 800 | ---- | 815 | ---- | |





Fluid 6821-6822

zamak / zamak / zamak / Zamak

acabado / finition / finish / Oberfläche

| | C | L | W | H | D | ---- | 250 | ---- | 750 |
|---------|---------|-----|-----------|-------|---|------|-----|------|-----|
| 6821--- | 320/288 | 363 | 760/12,80 | 33,80 | | | | | |
| 6822--- | 224/192 | 236 | 760/12,80 | 28,80 | | | | | |

ver más / voir plus / see more / siehe mehr

Black & White Collection / P. 34

P. 17

Fuji 6811-6812

zamak / zamak / zamak / Zamak

acabado / finition / finish / Oberfläche

| | C | L | W | H | D | ---- | 250 | ---- | 750 |
|---------|-----|-----|----|----|---|------|-----|------|-----|
| 6811--- | 224 | 320 | 20 | 32 | | | | | |
| 6812--- | 160 | 230 | 20 | 32 | | | | | |

ver más / voir plus / see more / siehe mehr

Black & White Collection / P. 32

Neo Rustik Collection / P. 76

P. 20

Basic 6761-6763-6765

zamak / zamak / zamak / Zamak

acabado / finition / finish / Oberfläche

| | C | L | W | H | D | ---- | 250 | ---- | 750 |
|---------|-----|-----|---|----|---|------|-----|------|-----|
| 6761--- | 320 | 328 | 8 | 28 | | | | | |
| 6763--- | 192 | 200 | 8 | 28 | | | | | |
| 6765--- | 128 | 136 | 8 | 28 | | | | | |

ver más / voir plus / see more / siehe mehr

Black & White Collection / P. 33

Neo Rustik Collection / P. 77

P. 28



Metal 7150

zamak / zamak / zamak / Zamak

acabado / finition / finish / Oberfläche

| | C | L | W | H | D | ---- | 250 | ---- | 750 |
|---------|----|-----|----|---|---|------|-----|------|-----|
| 7150--- | 96 | 152 | 20 | | | | | | |

ver más / voir plus / see more / siehe mehr

P. 66

Post 6831-6832

zamak / zamak / zamak / Zamak

acabado / finition / finish / Oberfläche

| | C | L | W | H | D | ---- | 250 | ---- | 750 |
|---------|-----|-----|----|----|---|------|-----|------|-----|
| 6831--- | 192 | 213 | 31 | 20 | | | | | |
| 6832--- | 128 | 149 | 31 | 20 | | | | | |

ver más / voir plus / see more / siehe mehr

Black & White Collection / P. 33

P. 14

Mini 8151

zamak / zamak / zamak / Zamak

acabado / finition / finish / Oberfläche

| | C | L | W | H | D | ---- | 250 | ---- | 750 |
|---------|---|----|----|----|---|------|-----|------|-----|
| 8151--- | | 25 | 25 | 28 | | | | | |

ver más / voir plus / see more / siehe mehr

P. 25

Mini 8161

zamak / zamak / zamak / Zamak

acabado / finition / finish / Oberfläche

| | C | L | W | H | D | ---- | 250 | ---- | 750 |
|---------|---|---|----|----|---|------|-----|------|-----|
| 8161--- | | | 28 | 25 | | | | | |

ver más / voir plus / see more / siehe mehr

Black & White Collection / P. 32

P. 25



GRAPHITE
COLLECTION

WRITING THE TREND

DULLGOLD
COLLECTION



Nature 9391

madera / bois / wood / Holz

| | C | L | W | H | D |
|------------------------------------------|-----|------|-----|----|---|
| 9391--- | 192 | 240 | 30 | 22 | |
| acabado / finition / finish / Oberfläche | | | | | |
| ---- | 046 | ---- | 047 | | |

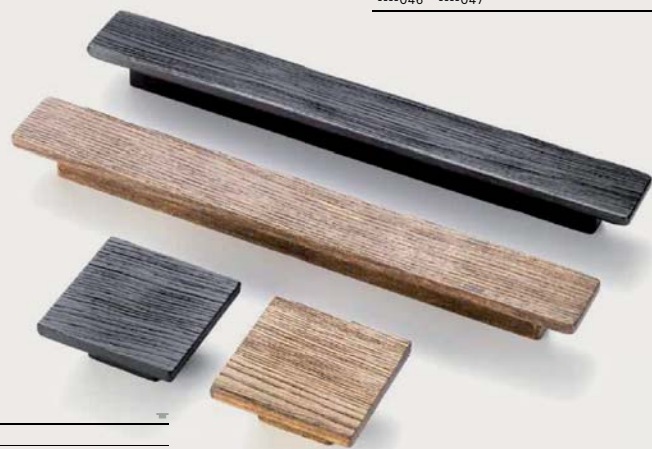

Nature 9390

madera / bois / wood / Holz

| | C | L | W | H | D |
|------------------------------------------|-----|------|-----|----|---|
| 9390--- | 16 | 55 | 55 | 22 | |
| acabado / finition / finish / Oberfläche | | | | | |
| ---- | 046 | ---- | 047 | | |



Slim 3541-3542

zamak / zamak / zamak / Zamak

| | C | L | W | HD' | HD² |
|------------------------------------------|-----|------|-----|--------|------|
| 3541--- | | 240 | 25 | 235x20 | 10,7 |
| 3542--- | | 150 | 25 | 145x20 | 10,7 |
| acabado / finition / finish / Oberfläche | | | | | |
| ---- | 038 | ---- | 800 | | |



Vanguardista / Avant-gardiste / Cutting-edge / Avantgardistisch

Straight 3750

zamak / zamak / zamak / Zamak

| | C | L | W | HD ¹ | HD ² |
|------------------------------------------|-----|-----|----|-----------------|-----------------|
| 3750--- | 192 | 202 | 55 | 199x52 | 14 |
| acabado / finition / finish / Oberfläche | | | | | |
| ----800 | | | | | |



Vanguardista / Avant-gardiste / Cutting-edge / Avantgardistisch

Seize 3730

zamak / zamak / zamak / Zamak

| | C | L | H | HD ¹ | HD ² |
|------------------------------------------|-----|-----|----|-----------------|-----------------|
| 3730--- | 170 | 180 | 25 | 157x19 | 18 |
| acabado / finition / finish / Oberfläche | | | | | |
| ----021 | | | | | |



vista posterior / face arrière
rear face / Rückansicht

Seize 3720

zamak / zamak / zamak / Zamak

| | C | L | H | HD ¹ | HD ² |
|------------------------------------------|-----|-----|----|-----------------|-----------------|
| 3720--- | 160 | 180 | 50 | 175x45 | 16 |
| acabado / finition / finish / Oberfläche | | | | | |
| ----021 ----038 ----400 ----800 | | | | | |

Seize 3740

zamak / zamak / zamak / Zamak

| | C | L | H | HD ¹ | HD ² |
|------------------------------------------|-----|-----|----|-----------------|-----------------|
| 3740--- | 160 | 180 | 45 | 168x40 | 16 |
| acabado / finition / finish / Oberfläche | | | | | |
| ----021 | | | | | |

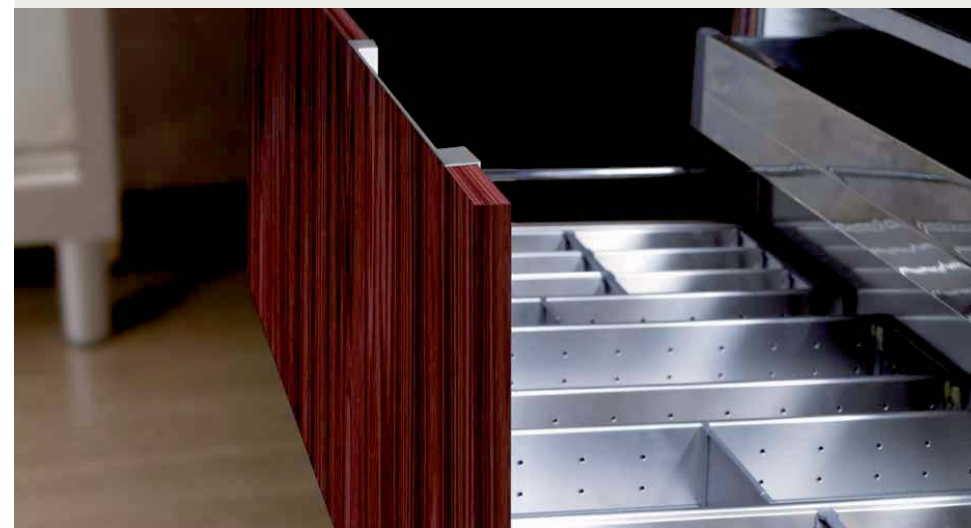

Vanguardista / Avant-gardiste / Cutting-edge / Avantgardistisch



Scene 3710

| | | | | | |
|------------------------------------------|-----|---------|---------|-----------------|-----------------|
| zamac / zamak / zamak / Zamak | | | | | |
| | C | L | W | HD ¹ | HD ² |
| 3710--- | 64 | 80 | 80 | 76x76 | 14 |
| acabado / finition / finish / Oberfläche | | | | | |
| ---- | 038 | ----100 | ----400 | ---- | 800 |



Vanguardista / Avant-gardiste / Cutting-edge / Avantgardistisch

Wing 7590

| | | | | | |
|------------------------------------------|-----|---------|---------|---------|---------|
| zamac / zamak / zamak / Zamak | | | | | |
| | C | L | W | H | D |
| 7590--- | 16 | 98 | 39 | 23 | |
| acabado / finition / finish / Oberfläche | | | | | |
| ---- | 021 | ----038 | ----292 | ----400 | ----800 |





Contemporáneo

Contemporain
Contemporary
Zeitgenössisch



Alustyle
P. 55

Contemporáneo / Contemporain / Contemporary / Zeitgenössisch

Stripe 7681-7684

zamak / zamak / zamak / Zamak

| | C | L | W | H | D |
|---------|-----|-----|----|----|---|
| 7681--- | 192 | 238 | 25 | 27 | |
| 7682--- | 160 | 195 | 24 | 27 | |
| 7683--- | 128 | 153 | 23 | 27 | |
| 7684--- | 96 | 120 | 22 | 27 | |

acabado / finition / finish / Oberfläche

----021 ----038 ----400 ----800



Contemporáneo / Contemporain / Contemporary / Zeitgenössisch

Smooth 7651-7653

zamak / zamak / zamak / Zamak

| | C | L | W | H | D |
|---------|-----|-----|----|----|---|
| 7651--- | 224 | 232 | 30 | 28 | |
| 7652--- | 192 | 200 | 30 | 28 | |
| 7653--- | 160 | 168 | 30 | 28 | |

acabado / finition / finish / Oberfläche

----038 ----400



Contemporáneo / Contemporain / Contemporary / Zeitgenössisch

Block 7461-7463

zamak / zamak / zamak / Zamak

| | C | L | W | H | D |
|---------|-----|-----|----|---|---|
| 7461--- | 160 | 197 | 21 | | |
| 7462--- | 128 | 161 | 19 | | |
| 7463--- | 96 | 129 | 18 | | |

acabado / finition / finish / Oberfläche

----021 ----038 ----400 ----800

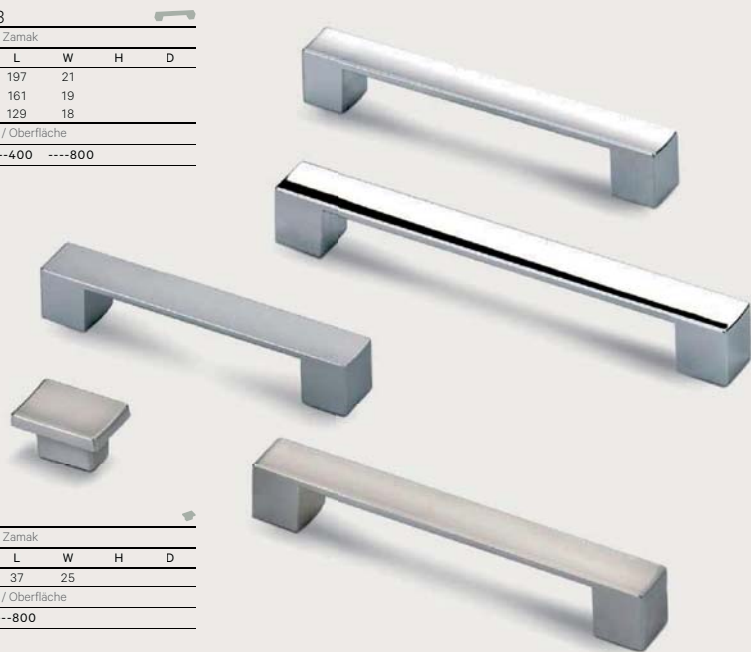

Block 8080

zamak / zamak / zamak / Zamak

| | C | L | W | H | D |
|---------|----|----|----|---|---|
| 8080--- | 16 | 37 | 25 | | |

acabado / finition / finish / Oberfläche

----038 ----400 ----800



Contemporáneo / Contemporain / Contemporary / Zeitgenössisch

Alustyle 7020-7026-7520-7521

aluminio / aluminium / aluminium / Aluminium

| | C | L | W | H | D |
|---------|-----|-----|----|----|---|
| 7020--- | 448 | 462 | 14 | 35 | |
| 7021--- | 384 | 398 | 14 | 35 | |
| 7022--- | 288 | 302 | 14 | 35 | |
| 7023--- | 224 | 238 | 14 | 35 | |
| 7024--- | 192 | 206 | 14 | 35 | |
| 7025--- | 160 | 174 | 14 | 35 | |
| 7026--- | 128 | 142 | 14 | 35 | |
| 7520--- | 832 | 846 | 14 | 35 | |
| 7521--- | 640 | 654 | 14 | 35 | |

acabado / finition / finish / Oberfläche

---018



Contemporáneo / Contemporain / Contemporary / Zeitgenössisch

Square 7471-7473

zamak / zamak / zamak / Zamak

| | C | L | W | H | D |
|---------|-----|-----|----|---|---|
| 7471--- | 128 | 146 | 12 | | |
| 7472--- | 96 | 114 | 11 | | |
| 7473--- | 64 | 81 | 10 | | |

acabado / finition / finish / Oberfläche

----021 ----038 ----400 ----800

ver más / voir plus / see more / siehe mehr

Neo Rustik Collection / P. 76

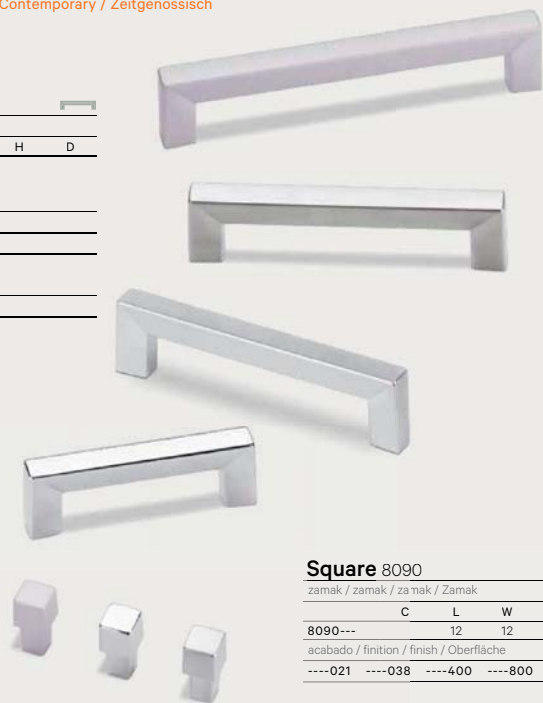

Square 8090

zamak / zamak / zamak / Zamak

| | C | L | W | H | D |
|---------|---|----|----|---|---|
| 8090--- | | 12 | 12 | | |

acabado / finition / finish / Oberfläche

----021 ----038 ----400 ----800



Contemporáneo / Contemporain / Contemporary / Zeitgenössisch

Cubic 7481-7483

zamak / zamak / zamak / Zamak

| | C | L | W | H | D |
|---------|----|-----|----|---|---|
| 7481--- | 96 | 115 | 12 | | |
| 7482--- | 64 | 85 | 11 | | |
| 7483--- | 32 | 55 | 10 | | |

acabado / finition / finish / Oberfläche

----021 ----038 ----400 ----800



Metal 7241-7242

zamak / zamak / zamak / Zamak

| | C | L | W | H | D |
|---------|-----|-----|----|---|---|
| 7241--- | 192 | 200 | 20 | | |
| 7242--- | 160 | 168 | 20 | | |

acabado / finition / finish / Oberfläche

----021 ----038 ----400 ----800



Contemporáneo / Contemporain / Contemporary / Zeitgenössisch

Metal 8851-8852

zamak / zamak / zamak / Zamak

| | C | L | W | H | D |
|------------------------------------------|-----|------|-----|------|-----|
| 8851--- | | 50 | 35 | | |
| 8852--- | | 35 | 24 | | |
| acabado / finition / finish / Oberfläche | | | | | |
| ---- | 038 | ---- | 400 | ---- | 800 |



Metal 7381-7382

zamak / zamak / zamak / Zamak

| | C | L | W | H | D |
|------------------------------------------|-----|------|-----|------|-----|
| 7381--- | 128 | 200 | 19 | | |
| 7382--- | 96 | 160 | 17 | | |
| acabado / finition / finish / Oberfläche | | | | | |
| ---- | 021 | ---- | 038 | ---- | 400 |
| ---- | | | | ---- | 800 |

Contemporáneo / Contemporain / Contemporary / Zeitgenössisch

Metal 7321-7322

zamak / zamak / zamak / Zamak

| | C | L | W | H | D |
|------------------------------------------|-----|------|-----|------|-----|
| 7321--- | 192 | 208 | 24 | | |
| 7322--- | 160 | 176 | 24 | | |
| acabado / finition / finish / Oberfläche | | | | | |
| ---- | 021 | ---- | 038 | ---- | 400 |
| ---- | | | | ---- | 800 |



Metal 8800

zamak / zamak / zamak / Zamak

| | C | L | W | H | D |
|------------------------------------------|-----|------|-----|------|-----|
| 8800--- | | 30 | 22 | | |
| acabado / finition / finish / Oberfläche | | | | | |
| ---- | 021 | ---- | 038 | ---- | 400 |
| ---- | | | | ---- | 800 |



Contemporáneo / Contemporain / Contemporary / Zeitgenössisch



Metal 7140

zamak / zamak / zamak / Zamak

| | C | L | W | H | D |
|---------|----|----|----|---|---|
| 7140--- | 32 | 53 | 19 | | |

acabado / finition / finish / Oberfläche

| | | | | | | | | | | | | | |
|------|-----|------|-----|------|-----|------|-----|------|-----|------|-----|------|-----|
| ---- | 021 | ---- | 032 | ---- | 038 | ---- | 100 | ---- | 400 | ---- | 500 | ---- | 800 |
|------|-----|------|-----|------|-----|------|-----|------|-----|------|-----|------|-----|



Metal 7131-7132

zamak / zamak / zamak / Zamak

| | C | L | W | H | D |
|---------|-----|-----|----|---|---|
| 7131--- | 128 | 165 | 20 | | |
| 7132--- | 96 | 130 | 16 | | |

acabado / finition / finish / Oberfläche

| | | | | | | | | | | | | | |
|------|-----|------|-----|------|-----|------|-----|------|-----|------|-----|------|-----|
| ---- | 021 | ---- | 032 | ---- | 038 | ---- | 100 | ---- | 400 | ---- | 500 | ---- | 800 |
|------|-----|------|-----|------|-----|------|-----|------|-----|------|-----|------|-----|



Contemporáneo / Contemporain / Contemporary / Zeitgenössisch



Metal 7031-7032

zamak / zamak / zamak / Zamak

| | C | L | W | H | D |
|---------|-----|-----|----|---|---|
| 7031--- | 128 | 160 | 14 | | |
| 7032--- | 96 | 126 | 13 | | |

acabado / finition / finish / Oberfläche

| | | | | | | | | | | | | | | | |
|------|-----|------|-----|------|-----|------|-----|------|-----|------|-----|------|-----|------|-----|
| ---- | 030 | ---- | 038 | ---- | 100 | ---- | 400 | ---- | 800 | ---- | 807 | ---- | 831 | ---- | 836 |
|------|-----|------|-----|------|-----|------|-----|------|-----|------|-----|------|-----|------|-----|

Contemporáneo / Contemporain / Contemporary / Zeitgenössisch



Metal 7861-7862

zamak / zamak / zamak / Zamak

| | C | L | W | H | D |
|---------|-----|-----|---|---|----|
| 7861--- | 128 | 164 | | | 10 |
| 7862--- | 96 | 124 | | | 9 |

acabado / finition / finish / Oberfläche

----002 ----021 ----033 ----038 ----100 ----400 ----500 ----800

ver más / voir plus / see more / siehe mehr

P. 71

Contemporáneo / Contemporain / Contemporary / Zeitgenössisch



Push 3530-3533

zamak / zamak / zamak / Zamak

| | C | L | D | HD ¹ | HD ² |
|---------|---|---|------|-----------------|-----------------|
| 3530--- | | | 74,7 | 69,5 | 11,1 |
| 3531--- | | | 63,8 | 59,5 | 11,3 |
| 3532--- | | | 49 | 44,5 | 10,9 |
| 3533--- | | | 39,8 | 34,8 | 11,2 |

acabado / finition / finish / Oberfläche

----038 ----800



Contemporáneo / Contemporain / Contemporary / Zeitgenössisch

Up 3281

zamak / zamak / zamak / Zamak

| | C | L | W | H | D |
|------------------------------------------|-----|-----|-----|-----|-----|
| 3281--- | 64 | 90 | 10 | 50 | |
| acabado / finition / finish / Oberfläche | | | | | |
| ---- | 002 | 038 | 400 | 500 | 800 |

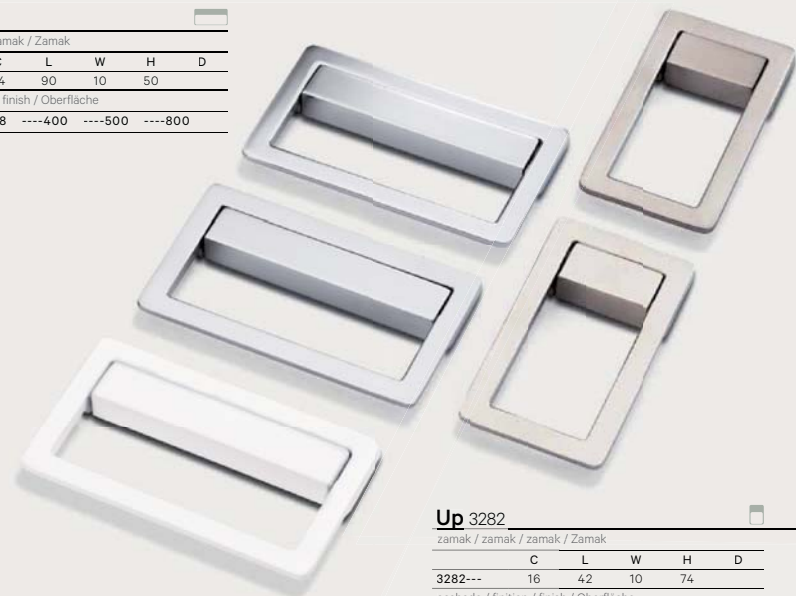

Up 3282

zamak / zamak / zamak / Zamak

| | C | L | W | H | D |
|------------------------------------------|-----|-----|-----|-----|-----|
| 3282--- | 16 | 42 | 10 | 74 | |
| acabado / finition / finish / Oberfläche | | | | | |
| ---- | 002 | 038 | 400 | 500 | 800 |



Contemporáneo / Contemporain / Contemporary / Zeitgenössisch

Stylus 3560-3562-3600

zamak / zamak / zamak / Zamak

| | C | L | W | HD ¹ | HD ² |
|---------|----|----|-------|-----------------|-----------------|
| 3600--- | 64 | 64 | 60x60 | 11 | |
| 3560--- | 50 | 50 | 45x45 | 11 | |
| 3561--- | 39 | 39 | 35x35 | 11 | |
| 3562--- | 29 | 29 | 26x26 | 11 | |

acabado / finition / finish / Oberfläche

----038 ----100 ----400 ----800



Stylus 3500-3510-3512

zamak / zamak / zamak / Zamak

| | C | L | D | HD ¹ | HD ² |
|---------|---|---|----|-----------------|-----------------|
| 3500--- | | | 65 | 60 | 11 |
| 3510--- | | | 49 | 45 | 11 |
| 3511--- | | | 40 | 35 | 11 |
| 3512--- | | | 30 | 26 | 11 |

acabado / finition / finish / Oberfläche

----002 ----038 ----100 ----400 ----800

ver más / voir plus / see more / siehe mehr

Black & White Collection / P. 33



Metal 7051-7052

| zamak / zamak / zamak / Zamak | | acabado / finition / finish / Oberfläche | | | |
|-------------------------------|-----|------------------------------------------|----|---|---------------------------------|
| C | L | W | H | D | ---- |
| 7051--- | 128 | 148 | 16 | | ----038 ----100 ----400 ----800 |
| 7052--- | 96 | 112 | 13 | | |



Metal 8671-8673

| zamak / zamak / zamak / Zamak | | acabado / finition / finish / Oberfläche | | | |
|-------------------------------|----|------------------------------------------|---|---|---------------------------------|
| C | L | W | H | D | ---- |
| 8671--- | 34 | 22 | | | ----038 ----100 ----400 ----800 |
| 8672--- | 31 | 20 | | | |
| 8673--- | 25 | 17 | | | |



Metal 7411-7412

| zamak / zamak / zamak / Zamak | | acabado / finition / finish / Oberfläche | | | |
|-------------------------------|-----|------------------------------------------|----|---|---------|
| C | L | W | H | D | ---- |
| 7411--- | 160 | 192 | 22 | | ----038 |
| 7412--- | 128 | 153 | 21 | | |



Metal 7291-7292

| zamak / zamak / zamak / Zamak | | acabado / finition / finish / Oberfläche | | | |
|-------------------------------|----|------------------------------------------|----|---|-----------------------------------------|
| C | L | W | H | D | ---- |
| 7291--- | 64 | 81 | 12 | | ----021 ----038 ----400 ----500 ----800 |
| 7292--- | 32 | 48 | 12 | | |



Metal 7281-7282

| zamak / zamak / zamak / Zamak | | acabado / finition / finish / Oberfläche | | | |
|-------------------------------|-----|------------------------------------------|----|---|-----------------|
| C | L | W | H | D | ---- |
| 7281--- | 192 | 242 | 12 | | ----038 ----400 |
| 7282--- | 128 | 178 | 12 | | |



Metal 7150

| zamak / zamak / zamak / Zamak | | acabado / finition / finish / Oberfläche | | | |
|-------------------------------|----|------------------------------------------|----|---|-----------------------------------------|
| C | L | W | H | D | ---- |
| 7150--- | 96 | 152 | 20 | | ----021 ----038 ----400 ----500 ----800 |

ver más / voir plus / see more / siehe mehr
Graphite & Dull Gold Collection / P. 43



Metal 8701-8702

| zamak / zamak / zamak / Zamak | | acabado / finition / finish / Oberfläche | | | |
|-------------------------------|----|------------------------------------------|---------|---------|-----------------------------------------|
| H | D | ---- | ---- | ---- | ---- |
| 8701--- | 35 | ----002 | ----030 | ----038 | ----100 ----400 ----800 ----831 ----836 |
| 8702--- | 30 | | | | |



Metal 8711-8712

| zamak / zamak / zamak / Zamak | | acabado / finition / finish / Oberfläche | | | |
|-------------------------------|----|------------------------------------------|---|---|-----------------|
| C | L | W | H | D | ---- |
| 8711--- | 37 | 30 | | | ----038 ----800 |
| 8712--- | 32 | 26 | | | |



Metal 7121-7122

| zamak / zamak / zamak / Zamak | | acabado / finition / finish / Oberfläche | | | |
|-------------------------------|-----|------------------------------------------|----|---|---------|
| C | L | W | H | D | ---- |
| 7121--- | 128 | 163 | 23 | | ----038 |
| 7122--- | 96 | 129 | 20 | | |



Metal 8731-8732

| zamak / zamak / zamak / Zamak | | acabado / finition / finish / Oberfläche | | | |
|-------------------------------|---|------------------------------------------|---|----|---------|
| C | L | W | H | D | ---- |
| 8731--- | | | | 35 | ----038 |
| 8732--- | | | | 30 | |



Metal 7081-7082

| zamak / zamak / zamak / Zamak | | acabado / finition / finish / Oberfläche | | | |
|-------------------------------|-----|------------------------------------------|----|---|---------|
| C | L | W | H | D | ---- |
| 7081--- | 128 | 142 | 15 | | ----038 |
| 7082--- | 96 | 107 | 13 | | |



Metal 7061

| zamak / zamak / zamak / Zamak | | acabado / finition / finish / Oberfläche | | | |
|-------------------------------|----|------------------------------------------|---|----|---------------------------------|
| C | L | W | H | D | ---- |
| 7061--- | 96 | 130 | | 11 | ----032 ----038 ----100 ----800 |



Metal 7991-7992

| zamak / zamak / zamak / Zamak | | acabado / finition / finish / Oberfläche | | | |
|-------------------------------|----|------------------------------------------|---|---|-----------------------------------------|
| C | L | W | H | D | ---- |
| 7991--- | 96 | 111 | 7 | | ----021 ----038 ----100 ----400 ----500 |
| 7992--- | 64 | 76 | 6 | | |

Metal 8721-8722

| latón / laiton / brass / Messing | | acabado / finition / finish / Oberfläche | | | |
|----------------------------------|---|------------------------------------------|---|----|---------------------------------|
| C | L | W | H | D | ---- |
| 8721--- | | | | 18 | ----021 ----038 ----100 ----400 |
| 8722--- | | | | 13 | |





Metal 7552-7553

| zamak / zamak / zamak / Zamak | | | | | | acabado / finition / finish / Oberfläche | | | | | | | |
|-------------------------------|----|-----|----|---|---|------------------------------------------|-----|------|-----|------|-----|------|-----|
| | C | L | W | H | D | ---- | 002 | ---- | 033 | ---- | 100 | ---- | 400 |
| 7552--- | 96 | 108 | 10 | | | | | | | | | | |
| 7553--- | 70 | 80 | 9 | | | | | | | | | | |



Metal 7554

| zamak / zamak / zamak / Zamak | | | | | | acabado / finition / finish / Oberfläche | | | | | | | |
|-------------------------------|----|----|---|---|---|------------------------------------------|-----|------|-----|------|-----|------|-----|
| | C | L | W | H | D | ---- | 002 | ---- | 033 | ---- | 100 | ---- | 400 |
| 7554--- | 32 | 42 | 9 | | | | | | | | | | |



Metal 8830

| zamak / zamak / zamak / Zamak | | | | | | acabado / finition / finish / Oberfläche | | | | | | | |
|-------------------------------|---|----|----|---|---|------------------------------------------|-----|------|-----|------|-----|------|-----|
| | C | L | W | H | D | ---- | 021 | ---- | 038 | ---- | 400 | ---- | 800 |
| 8830--- | | 30 | 19 | | | | | | | | | | |



Metal 8810

| latón / laiton / brass / Messing | | | | | | acabado / finition / finish / Oberfläche | | | | | | | |
|----------------------------------|---|---|---|---|----|------------------------------------------|-----|------|-----|--|--|--|--|
| | C | L | W | H | D | ---- | 021 | ---- | 038 | | | | |
| 8810--- | | | | | 16 | | | | | | | | |



Metal 8820

| latón / laiton / brass / Messing | | | | | | acabado / finition / finish / Oberfläche | | | | | | | |
|----------------------------------|---|---|---|---|----|------------------------------------------|-----|------|-----|--|--|--|--|
| | C | L | W | H | D | ---- | 021 | ---- | 038 | | | | |
| 8820--- | | | | | 16 | | | | | | | | |

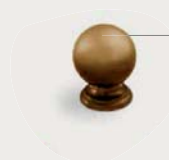

Metal 8351-8354

| zamak / zamak / zamak / Zamak | | | | | | acabado / finition / finish / Oberfläche | | | | | | | |
|-------------------------------|---|---|---|---|----|------------------------------------------|-----|------|-----|------|-----|------|-----|
| | C | L | W | H | D | ---- | 100 | ---- | 400 | ---- | 800 | ---- | 900 |
| 8351--- | | | | | 33 | | | | | | | | |
| 8352--- | | | | | 28 | | | | | | | | |
| 8353--- | | | | | 24 | | | | | | | | |
| 8354--- | | | | | 18 | | | | | | | | |



Metal 8321-8324

| zamak / zamak / zamak / Zamak | | | | | | acabado / finition / finish / Oberfläche | | | | | | | |
|-------------------------------|---|---|---|---|----|------------------------------------------|-----|------|-----|------|-----|------|-----|
| | C | L | W | H | D | ---- | 038 | ---- | 100 | ---- | 400 | ---- | 800 |
| 8321--- | | | | | 33 | | | | | | | | |
| 8322--- | | | | | 28 | | | | | | | | |
| 8323--- | | | | | 24 | | | | | | | | |
| 8324--- | | | | | 18 | | | | | | | | |



Metal 8010

| zamak / zamak / zamak / Zamak | | | | | | acabado / finition / finish / Oberfläche | | | | | | | | | |
|-------------------------------|---|---|---|---|----|------------------------------------------|-----|------|-----|------|-----|------|-----|------|-----|
| | C | L | W | H | D | ---- | 002 | ---- | 021 | ---- | 033 | ---- | 100 | ---- | 400 |
| 8010--- | | | | | 12 | | | | | | | | | | |



Metal 8790

| zamak / zamak / zamak / Zamak | | | | | | acabado / finition / finish / Oberfläche | | | | | | | |
|-------------------------------|---|---|---|---|----|------------------------------------------|-----|------|-----|------|-----|--|--|
| | C | L | W | H | D | ---- | 021 | ---- | 038 | ---- | 400 | | |
| 8790--- | | | | | 20 | | | | | | | | |



Metal 8471-8473

| zamak / zamak / zamak / Zamak | | | | | | acabado / finition / finish / Oberfläche | | | | | | | |
|-------------------------------|---|---|---|---|----|------------------------------------------|-----|------|-----|------|-----|------|-----|
| | C | L | W | H | D | ---- | 100 | ---- | 102 | ---- | 400 | ---- | 900 |
| 8471--- | | | | | 35 | | | | | | | | |
| 8472--- | | | | | 30 | | | | | | | | |
| 8473--- | | | | | 25 | | | | | | | | |



Metal 8461-8463

| zamak / zamak / zamak / Zamak | | | | | | acabado / finition / finish / Oberfläche | | | | | | | |
|-------------------------------|---|---|---|---|----|------------------------------------------|-----|------|-----|------|-----|--|--|
| | C | L | W | H | D | ---- | 100 | ---- | 805 | ---- | 900 | | |
| 8461--- | | | | | 35 | | | | | | | | |
| 8462--- | | | | | 30 | | | | | | | | |
| 8463--- | | | | | 25 | | | | | | | | |



Metal 8661

| zamak / zamak / zamak / Zamak | | | | | | acabado / finition / finish / Oberfläche | | | | | | | |
|-------------------------------|---|---|---|---|----|------------------------------------------|-----|------|-----|--|--|--|--|
| | C | L | W | H | D | ---- | 038 | ---- | 100 | | | | |
| 8661--- | | | | | 35 | | | | | | | | |



Acero Inox 7950-7954

| acero inoxidable-zamak / acier inox-zamak / stainless steel-zamak / Rostfreier Stahl-Zamak | | | | | acabado / finition / finish / Oberfläche |
|--------------------------------------------------------------------------------------------|-----|-----|---|----|------------------------------------------|
| C | L | W | H | D | ---- |
| 7950--- | 448 | 470 | | 12 | ---- |
| 7951--- | 320 | 342 | | 12 | ---- |
| 7952--- | 224 | 246 | | 12 | ---- |
| 7953--- | 160 | 182 | | 12 | ---- |
| 7954--- | 128 | 150 | | 12 | ---- |

acabado / finition / finish / Oberfläche
----031



Acero Inox 7000-7009

| acero inoxidable-zamak / acier inox-zamak / stainless steel-zamak / Rostfreier Stahl-Zamak | | | | | acabado / finition / finish / Oberfläche |
|--------------------------------------------------------------------------------------------|------|------|---|----|------------------------------------------|
| C | L | W | H | D | ---- |
| 7000--- | 1280 | 1310 | | 14 | ---- |
| 7001--- | 896 | 926 | | 14 | ---- |
| 7002--- | 672 | 702 | | 14 | ---- |
| 7003--- | 448 | 478 | | 14 | ---- |
| 7004--- | 384 | 414 | | 14 | ---- |
| 7005--- | 288 | 318 | | 14 | ---- |
| 7006--- | 224 | 254 | | 14 | ---- |
| 7007--- | 192 | 222 | | 14 | ---- |
| 7008--- | 160 | 190 | | 14 | ---- |
| 7009--- | 128 | 158 | | 14 | ---- |

acabado / finition / finish / Oberfläche
----031



Acero Inox 7010-7019

| acero inoxidable / acier inox / stainless steel / Rostfreier Stahl | | | | | acabado / finition / finish / Oberfläche |
|--------------------------------------------------------------------|------|------|---|----|------------------------------------------|
| C | L | W | H | D | ---- |
| 7010--- | 1280 | 1330 | | 12 | ---- |
| 7011--- | 896 | 946 | | 12 | ---- |
| 7012--- | 672 | 722 | | 12 | ---- |
| 7013--- | 448 | 498 | | 12 | ---- |
| 7014--- | 384 | 434 | | 12 | ---- |
| 7015--- | 288 | 338 | | 12 | ---- |
| 7016--- | 224 | 274 | | 12 | ---- |
| 7017--- | 192 | 242 | | 12 | ---- |
| 7018--- | 160 | 210 | | 12 | ---- |
| 7019--- | 128 | 178 | | 12 | ---- |

acabado / finition / finish / Oberfläche
----031

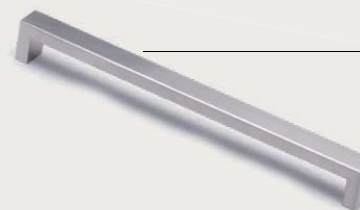

Unix 7501-7506

| acero inoxidable / acier inox / stainless steel / Rostfreier Stahl | | | | | acabado / finition / finish / Oberfläche |
|--------------------------------------------------------------------|-----|-----|----|----|------------------------------------------|
| C | L | W | H | D | ---- |
| 7501--- | 320 | 333 | 25 | 38 | ---- |
| 7502--- | 288 | 301 | 25 | 38 | ---- |
| 7503--- | 256 | 269 | 25 | 38 | ---- |
| 7504--- | 224 | 237 | 25 | 38 | ---- |
| 7505--- | 192 | 205 | 25 | 38 | ---- |
| 7506--- | 160 | 173 | 25 | 38 | ---- |

acabado / finition / finish / Oberfläche
----031

ver más / voir plus / see more / siehe mehr
P. 111



Acero Inox 7921-7923

| acero inoxidable / acier inox / stainless steel / Rostfreier Stahl | | | | | acabado / finition / finish / Oberfläche |
|--------------------------------------------------------------------|-----|-----|---|----|------------------------------------------|
| C | L | W | H | D | ---- |
| 7921--- | 160 | 200 | | 10 | ---- |
| 7922--- | 128 | 166 | | 10 | ---- |
| 7923--- | 96 | 132 | | 10 | ---- |

acabado / finition / finish / Oberfläche
----031

Acero Inox 8921-8922

| acero inoxidable / acier inox / stainless steel / Rostfreier Stahl | | | | | acabado / finition / finish / Oberfläche |
|--------------------------------------------------------------------|---|---|---|----|------------------------------------------|
| C | L | W | H | D | ---- |
| 8921--- | | | | 18 | ---- |
| 8922--- | | | | 13 | ---- |

acabado / finition / finish / Oberfläche
----031



Acero Inox 7610-7614-7810-7814

| acero inoxidable / acier inox / stainless steel / Rostfreier Stahl | | | | | acabado / finition / finish / Oberfläche |
|--------------------------------------------------------------------|-----|-----|------|----|------------------------------------------|
| C | L | W | H | D | ---- |
| 7610--- | 288 | 298 | 26 | 10 | ---- |
| 7611--- | 192 | 202 | 25,5 | 10 | ---- |
| 7612--- | 160 | 170 | 25,5 | 10 | ---- |
| 7613--- | 128 | 138 | 25,5 | 10 | ---- |
| 7614--- | 96 | 106 | 25 | 10 | ---- |
| 7810--- | 192 | 200 | 21 | 8 | ---- |
| 7811--- | 160 | 168 | 21 | 8 | ---- |
| 7812--- | 128 | 136 | 21 | 8 | ---- |
| 7813--- | 96 | 104 | 21 | 8 | ---- |
| 7814--- | 64 | 72 | 21 | 8 | ---- |

acabado / finition / finish / Oberfläche
----031 ----037

Acero Inox 8361-8363

| acero inoxidable / acier inox / stainless steel / Rostfreier Stahl | | | | | acabado / finition / finish / Oberfläche |
|--------------------------------------------------------------------|---|---|---|----|------------------------------------------|
| C | L | W | H | D | ---- |
| 8361--- | | | | 30 | ---- |
| 8362--- | | | | 25 | ---- |
| 8363--- | | | | 20 | ---- |

acabado / finition / finish / Oberfläche
----031 ----037

Acero Inox 7861-7862

| acero inoxidable / acier inox / stainless steel / Rostfreier Stahl | | | | | acabado / finition / finish / Oberfläche |
|--------------------------------------------------------------------|-----|-----|---|----|------------------------------------------|
| C | L | W | H | D | ---- |
| 7861--- | 128 | 145 | | 10 | ---- |
| 7862--- | 96 | 110 | | 10 | ---- |

acabado / finition / finish / Oberfläche
----031

ver más / voir plus / see more / siehe mehr
P. 62





Poli-dur 5101-5102

| | | | | | |
|-------------------------------------------------------------------|---|---|---|----|------------------------------------------|
| poli-dur-zamak / poli-dur-zamak / poli-dur-zamak / Poli-dur-Zamak | | | | | acabado / finition / finish / Oberfläche |
| C | L | W | H | D | ----102 ----133 |
| 5101--- | | | | 34 | |
| 5102--- | | | | 28 | |



Poli-dur 5001-5002

| | | | | | |
|-------------------------------------------|---|---|---|----|------------------------------------------|
| poli-dur / poli-dur / poli-dur / Poli-dur | | | | | acabado / finition / finish / Oberfläche |
| C | L | W | H | D | ----002 ----033 |
| 5001--- | | | | 34 | |
| 5002--- | | | | 28 | |



Poli-dur 5221-5222

| | | | | | |
|-------------------------------------------|---|---|---|----|------------------------------------------|
| poli-dur / poli-dur / poli-dur / Poli-dur | | | | | acabado / finition / finish / Oberfläche |
| C | L | W | H | D | ----002 ----033 |
| 5221--- | | | | 37 | |
| 5222--- | | | | 32 | |



Poli-dur 5201-5202

| | | | | | |
|-------------------------------------------------------------------|---|---|---|----|------------------------------------------|
| poli-dur-zamak / poli-dur-zamak / poli-dur-zamak / Poli-dur-Zamak | | | | | acabado / finition / finish / Oberfläche |
| C | L | W | H | D | ----002 ----033 |
| 5201--- | | | | 34 | |
| 5202--- | | | | 28 | |



Madera 9062-9063

| | | | | | |
|-----------------------------|---|---|---|----|------------------------------------------|
| madera / bois / wood / Holz | | | | | acabado / finition / finish / Oberfläche |
| C | L | W | H | D | ----014 ----015 ----016 ----025 ----035 |
| 9062--- | | | | 40 | |
| 9063--- | | | | 30 | |



Inlay 3701-3703

| | | | | | |
|-------------------------------|-----|----|-----------------|-----------------|------------------------------------------|
| zamak / zamak / zamak / Zamak | | | | | acabado / finition / finish / Oberfläche |
| C | L | W | HD ¹ | HD ² | ----038 ----100 ----400 ----800 |
| 3701--- | 145 | 50 | 139x40 | 11 | |
| 3702--- | 113 | 42 | 110x35 | 11 | |
| 3703--- | 83 | 36 | 78x26 | 11 | |



Placa 3940

| | | | | | |
|-------------------------------|----|-----|----|---|------------------------------------------|
| zamak / zamak / zamak / Zamak | | | | | acabado / finition / finish / Oberfläche |
| C | L | W | H | D | ----021 ----038 ----805 ----807 ----836 |
| 3940--- | 64 | 130 | 34 | | |



Placa 3261

| | | | | | |
|-------------------------------|----|----|---|---|------------------------------------------|
| zamak / zamak / zamak / Zamak | | | | | acabado / finition / finish / Oberfläche |
| C | L | W | H | D | ----002 ----038 ----100 ----500 ----800 |
| 3261--- | 80 | 35 | | | |



Placa 3262

| | | | | | |
|-------------------------------|----|----|---|---|------------------------------------------|
| zamak / zamak / zamak / Zamak | | | | | acabado / finition / finish / Oberfläche |
| C | L | W | H | D | ----002 ----038 ----100 ----500 ----800 |
| 3262--- | 36 | 36 | | | |



Placa 3251

| | | | | | |
|-------------------------------|----|----|---|---|------------------------------------------|
| zamak / zamak / zamak / Zamak | | | | | acabado / finition / finish / Oberfläche |
| C | L | W | H | D | ----112 ----413 |
| 3251--- | 70 | 40 | | | |



Placa 3252

| | | | | | |
|-------------------------------|----|----|---|---|------------------------------------------|
| zamak / zamak / zamak / Zamak | | | | | acabado / finition / finish / Oberfläche |
| C | L | W | H | D | ----112 ----413 |
| 3252--- | 35 | 35 | | | |



Placa 3271

| | | | | | |
|-------------------------------|----|----|---|---|------------------------------------------|
| zamak / zamak / zamak / Zamak | | | | | acabado / finition / finish / Oberfläche |
| C | L | W | H | D | ----100 ----200 ----500 |
| 3271--- | 82 | 38 | | | |



Placa 3272

| | | | | | |
|-------------------------------|----|----|---|---|------------------------------------------|
| zamak / zamak / zamak / Zamak | | | | | acabado / finition / finish / Oberfläche |
| C | L | W | H | D | ----100 ----200 ----500 |
| 3272--- | 38 | 50 | | | |



Placa 3921-3922

| | | | | | |
|-------------------------------|-----|----|-----------------|-----------------|-------------------------------------------------|
| zamak / zamak / zamak / Zamak | | | | | acabado / finition / finish / Oberfläche |
| C | L | W | HD ¹ | HD ² | ----002 ----038 ----100 ----400 ----800 ----831 |
| 3921--- | 150 | 40 | 103x26 | 11 | |
| 3922--- | 110 | 36 | 69x26 | 11 | |



Placa 3801-3802

| | | | | | |
|--------------------------------------------------------|-----|----|-----------------|-----------------|------------------------------------------|
| latón-hierro / laiton-fer / brass-iron / messing-eisen | | | | | acabado / finition / finish / Oberfläche |
| C | L | W | HD ¹ | HD ² | ----112 ----403 ----413 |
| 3801--- | 115 | 42 | 93x32 | 13 | |
| 3802--- | 80 | 36 | 67x27 | 13 | |



Placa 3900

| | | | | | |
|-------------------------------|----|-----|-----------------|-----------------|------------------------------------------|
| zamak / zamak / zamak / Zamak | | | | | acabado / finition / finish / Oberfläche |
| C | L | W | HD ¹ | HD ² | ----112 ----413 |
| 3900--- | 96 | 110 | 40 | 104x30 | 12 |



Placa 3930

| | | | | | |
|-------------------------------|----|-----|-----------------|-----------------|------------------------------------------|
| zamak / zamak / zamak / Zamak | | | | | acabado / finition / finish / Oberfläche |
| C | L | W | HD ¹ | HD ² | ----112 ----413 |
| 3930--- | 96 | 110 | 40 | 88x30 | 12 |



Rústico
Rustique
Rustic
Rustikal



Provence
P. 78

Rústico / Rustique / Rustic / Rustikal

Square 7471-7473

zamak / zamak / zamak / Zamak

| | C | L | W | H | D |
|---------|-----|-----|----|---|---|
| 7471--- | 128 | 146 | 12 | | |
| 7472--- | 96 | 114 | 11 | | |
| 7473--- | 64 | 81 | 10 | | |

acabado / finition / finish / Oberfläche
 ----808 ----831 ----836

ver más / voir plus / see more / siehe mehr
 P. 56

Fuji 6811-6812

zamak / zamak / zamak / Zamak

| | C | L | W | H | D |
|---------|-----|-----|----|----|---|
| 6811--- | 224 | 320 | 20 | 32 | |
| 6812--- | 160 | 230 | 20 | 32 | |

acabado / finition / finish / Oberfläche
 ----808 ----831 ----836

ver más / voir plus / see more / siehe mehr
Black & White Collection / P. 32
Graphite & Dull Gold Collection / P. 42
 P. 20

NEORUSTIK
 COLLECTION

QUALITY IN EVOLUTION



Lips 6781-6782

zamak / zamak / zamak / Zamak

| | C | L | W | H | D |
|---------|-----|-----|----|---|---|
| 6781--- | 224 | 320 | 45 | | |
| 6782--- | 160 | 240 | 45 | | |

acabado / finition / finish / Oberfläche
 ----808 ----831 ----836

ver más / voir plus / see more / siehe mehr
Black & White Collection / P. 35
 P. 22

Rústico / Rustique / Rustic / Rustikal

Synthesis 7661-7663

zamak / zamak / zamak / Zamak

| | C | L | W | H | D |
|---------|-----|-----|----|----|---|
| 7661--- | 192 | 230 | 44 | 24 | |
| 7662--- | 96 | 135 | 44 | 24 | |
| 7663--- | 32 | 71 | 44 | 24 | |

acabado / finition / finish / Oberfläche
 ----808 ----831 ----836

ver más / voir plus / see more / siehe mehr
Black & White Collection / P. 35
 P. 37

Basic 6761-6765

zamak / zamak / zamak / Zamak

| | C | L | W | H | D |
|---------|-----|-----|---|----|---|
| 6761--- | 320 | 328 | 8 | 28 | |
| 6762--- | 256 | 264 | 8 | 28 | |
| 6763--- | 192 | 200 | 8 | 28 | |
| 6764--- | 160 | 168 | 8 | 28 | |
| 6765--- | 128 | 136 | 8 | 28 | |

acabado / finition / finish / Oberfläche
 ----808 ----831 ----836

ver más / voir plus / see more / siehe mehr
Black & White Collection / P. 33
Graphite & Dull Gold Collection / P. 42
 P. 28

Rústico / Rustique / Rustic / Rustikal

Provence 6521

zamak / zamak / zamak / Zamak

| | C | L | W | H | D |
|------------------------------------------|-----|------|-----|------|-----|
| 6521--- | 96 | 154 | 22 | 30 | |
| acabado / finition / finish / Oberfläche | | | | | |
| ---- | 805 | ---- | 825 | ---- | 831 |



Provence 8521

zamak / zamak / zamak / Zamak

| | C | L | W | H | D |
|------------------------------------------|-----|------|-----|------|-----|
| 8521--- | | | | 24 | 36 |
| acabado / finition / finish / Oberfläche | | | | | |
| ---- | 805 | ---- | 825 | ---- | 831 |



Rústico / Rustique / Rustic / Rustikal

Laps 6131-6132

zamak / zamak / zamak / Zamak

| | C | L | W | H | D |
|------------------------------------------|-----|------|-----|------|-----|
| 6131--- | 192 | 222 | 22 | 21 | |
| 6132--- | 128 | 159 | 22 | 21 | |
| acabado / finition / finish / Oberfläche | | | | | |
| ---- | 100 | ---- | 400 | ---- | 500 |
| ---- | | | | 831 | 836 |



Laps 6130

zamak / zamak / zamak / Zamak

| | C | L | W | H | D |
|------------------------------------------|-----|------|-----|------|-----|
| 6130--- | | | | 23 | 45 |
| acabado / finition / finish / Oberfläche | | | | | |
| ---- | 100 | ---- | 400 | ---- | 500 |
| ---- | | | | 831 | 836 |



Rústico / Rustique / Rustic / Rustikal



Rough 6150

zamak / zamak / zamak / Zamak

| | C | L | W | H | D |
|------------------------------------------|---------|---------|---------|---|---|
| 6150--- | 42 | 42 | 25 | | |
| acabado / finition / finish / Oberfläche | | | | | |
| ----400 | ----500 | ----831 | ----836 | | |

Rough 6151-6152

zamak / zamak / zamak / Zamak

| | C | L | W | H | D |
|------------------------------------------|---------|---------|---------|----|---|
| 6151--- | 128 | 169 | 25 | 27 | |
| 6152--- | 96 | 127 | 23 | 26 | |
| acabado / finition / finish / Oberfläche | | | | | |
| ----400 | ----500 | ----831 | ----836 | | |



Rústico / Rustique / Rustic / Rustikal

Ways 6170

zamak / zamak / zamak / Zamak

| | C | L | W | H | D |
|------------------------------------------|---------|---------|---------|----|----|
| 6170--- | | | | 25 | 45 |
| acabado / finition / finish / Oberfläche | | | | | |
| ----400 | ----500 | ----831 | ----836 | | |



Ways 6171

zamak / zamak / zamak / Zamak

| | C | L | W | H | D |
|------------------------------------------|---------|---------|---------|----|---|
| 6171--- | 128 | 136 | 22 | 27 | |
| acabado / finition / finish / Oberfläche | | | | | |
| ----400 | ----500 | ----831 | ----836 | | |



Rústico / Rustique / Rustic / Rustikal



Cell 8141-8142

zamak / zamak / zamak / Zamak

| | C | L | W | H | D |
|---------|----|----|----|---|---|
| 8141--- | 38 | 38 | 24 | | |
| 8142--- | 32 | 32 | 23 | | |

acabado / finition / finish / Oberfläche

| | | | | | | | | | |
|------|-----|------|-----|------|-----|------|-----|------|-----|
| ---- | 100 | ---- | 400 | ---- | 500 | ---- | 831 | ---- | 836 |
|------|-----|------|-----|------|-----|------|-----|------|-----|

Cell 6141-6142

zamak / zamak / zamak / Zamak

| | C | L | W | H | D |
|---------|-----|-----|----|----|---|
| 6141--- | 128 | 167 | 25 | 26 | |
| 6142--- | 96 | 131 | 22 | 25 | |

acabado / finition / finish / Oberfläche

| | | | | | | | | | |
|------|-----|------|-----|------|-----|------|-----|------|-----|
| ---- | 100 | ---- | 400 | ---- | 500 | ---- | 831 | ---- | 836 |
|------|-----|------|-----|------|-----|------|-----|------|-----|



Rústico / Rustique / Rustic / Rustikal

Cross 6161-6162

zamak / zamak / zamak / Zamak

| | C | L | W | H | D |
|---------|-----|-----|----|----|---|
| 6161--- | 128 | 136 | 30 | 27 | |
| 6162--- | 96 | 104 | 28 | 27 | |

acabado / finition / finish / Oberfläche

| | | | | | | | |
|------|-----|------|-----|------|-----|------|-----|
| ---- | 400 | ---- | 500 | ---- | 831 | ---- | 836 |
|------|-----|------|-----|------|-----|------|-----|



Cross 6160

zamak / zamak / zamak / Zamak

| | C | L | W | H | D |
|---------|----|----|----|---|---|
| 6160--- | 60 | 24 | 23 | | |

acabado / finition / finish / Oberfläche

| | | | | | | | |
|------|-----|------|-----|------|-----|------|-----|
| ---- | 400 | ---- | 500 | ---- | 831 | ---- | 836 |
|------|-----|------|-----|------|-----|------|-----|



Rústico / Rustique / Rustic / Rustikal

Spiral 7561-7562

zamak / zamak / zamak / Zamak

| | C | L | W | H | D |
|---------|-----|-----|----|----|---|
| 7561--- | 128 | 172 | 15 | 29 | |
| 7562--- | 96 | 130 | 13 | 28 | |

acabado / finition / finish / Oberfläche

| | | | | | | | | | | | |
|------|-----|------|-----|------|-----|------|-----|------|-----|------|-----|
| ---- | 100 | ---- | 500 | ---- | 810 | ---- | 825 | ---- | 831 | ---- | 836 |
|------|-----|------|-----|------|-----|------|-----|------|-----|------|-----|



Spiral 8561-8562

zamak / zamak / zamak / Zamak

| | C | L | W | H | D |
|---------|----|----|----|---|---|
| 8561--- | 32 | 21 | 25 | | |
| 8562--- | 28 | 18 | 22 | | |

acabado / finition / finish / Oberfläche

| | | | | | | | | | | | |
|------|-----|------|-----|------|-----|------|-----|------|-----|------|-----|
| ---- | 100 | ---- | 500 | ---- | 810 | ---- | 825 | ---- | 831 | ---- | 836 |
|------|-----|------|-----|------|-----|------|-----|------|-----|------|-----|



Rústico / Rustique / Rustic / Rustikal

Rope 7581-7582

zamak / zamak / zamak / Zamak

| | C | L | W | H | D |
|---------|-----|-----|----|----|---|
| 7581--- | 128 | 150 | 15 | 30 | |
| 7582--- | 96 | 114 | 13 | 27 | |

acabado / finition / finish / Oberfläche

| | | | | | | | | | | | |
|------|-----|------|-----|------|-----|------|-----|------|-----|------|-----|
| ---- | 100 | ---- | 500 | ---- | 810 | ---- | 825 | ---- | 831 | ---- | 836 |
|------|-----|------|-----|------|-----|------|-----|------|-----|------|-----|



Rope 8581

zamak / zamak / zamak / Zamak

| | C | L | W | H | D |
|---------|---|---|---|----|----|
| 8581--- | | | | 23 | 34 |

acabado / finition / finish / Oberfläche

| | | | | | | | | | | | |
|------|-----|------|-----|------|-----|------|-----|------|-----|------|-----|
| ---- | 100 | ---- | 500 | ---- | 810 | ---- | 825 | ---- | 831 | ---- | 836 |
|------|-----|------|-----|------|-----|------|-----|------|-----|------|-----|



Rústico / Rustique / Rustic / Rustikal

Rustic 8871

zamak / zamak / zamak / Zamak

| | C | L | W | H | D |
|---------|---|---|---|---|----|
| 8871--- | | | | | 30 |

acabado / finition / finish / Oberfläche

| | | | | | |
|---------|---------|---------|---------|---------|---------|
| ----805 | ----807 | ----808 | ----809 | ----831 | ----836 |
|---------|---------|---------|---------|---------|---------|



Rustic 7421-7422

zamak / zamak / zamak / Zamak

| | C | L | W | H | D |
|---------|----|-----|----|---|---|
| 7421--- | 96 | 120 | 14 | | |
| 7422--- | 64 | 81 | 11 | | |

acabado / finition / finish / Oberfläche

| | | | | | |
|---------|---------|---------|---------|---------|---------|
| ----805 | ----807 | ----808 | ----809 | ----831 | ----836 |
|---------|---------|---------|---------|---------|---------|

Rústico / Rustique / Rustic / Rustikal

Chess 7191-7192

zamak / zamak / zamak / Zamak

| | C | L | W | H | D |
|---------|-----|-----|---|---|---|
| 7191--- | 128 | 161 | | | |
| 7192--- | 96 | 136 | | | |

acabado / finition / finish / Oberfläche

| | | | | | |
|---------|---------|---------|---------|---------|---------|
| ----100 | ----500 | ----810 | ----825 | ----831 | ----836 |
|---------|---------|---------|---------|---------|---------|



Chess 8191-8192

zamak / zamak / zamak / Zamak

| | C | L | W | H | D |
|---------|---|----|----|---|---|
| 8191--- | | 34 | 34 | | |
| 8192--- | | 29 | 29 | | |

acabado / finition / finish / Oberfläche

| | | | | | |
|---------|---------|---------|---------|---------|---------|
| ----100 | ----500 | ----810 | ----825 | ----831 | ----836 |
|---------|---------|---------|---------|---------|---------|



Rústico / Rustique / Rustic / Rustikal

Reed 7491-7492

zamak / zamak / zamak / Zamak

| | C | L | W | H | D |
|------------------------------------------|-----|-----|-----|-----|---------|
| 7491--- | 128 | 163 | | | |
| 7492--- | 96 | 128 | | | |
| acabado / finition / finish / Oberfläche | | | | | |
| ---- | 100 | 500 | 810 | 825 | 831 836 |



Reed 8491

zamak / zamak / zamak / Zamak

| | C | L | W | H | D |
|------------------------------------------|-----|-----|-----|-----|---------|
| 8491--- | | 35 | 30 | | |
| acabado / finition / finish / Oberfläche | | | | | |
| ---- | 100 | 500 | 810 | 825 | 831 836 |



Rústico / Rustique / Rustic / Rustikal

Rustic 8841-8842

zamak / zamak / zamak / Zamak

| | C | L | W | H | D |
|------------------------------------------|-----|-----|-----|-----|-----|
| 8841--- | | | | | 34 |
| 8842--- | | | | | 28 |
| acabado / finition / finish / Oberfläche | | | | | |
| ---- | 038 | 808 | 809 | 831 | 836 |



Rustic 7371-7372

zamak / zamak / zamak / Zamak

| | C | L | W | H | D |
|------------------------------------------|-----|-----|-----|-----|-----|
| 7371--- | 128 | 178 | 22 | | |
| 7372--- | 96 | 137 | 20 | | |
| acabado / finition / finish / Oberfläche | | | | | |
| ---- | 038 | 808 | 809 | 831 | 836 |

Rustic 7830

zamak / zamak / zamak / Zamak

| | C | L | W | H | D |
|---------|----|-----|---|---|----|
| 7830--- | 96 | 110 | | | 11 |

acabado / finition / finish / Oberfläche

---100 ---102 ----831 ----836 ----900



Rustic 7251-7252

zamak / zamak / zamak / Zamak

| | C | L | W | H | D |
|---------|-----|-----|----|---|---|
| 7251--- | 128 | 149 | 20 | | |
| 7252--- | 96 | 117 | 18 | | |

acabado / finition / finish / Oberfläche

---038 ---100 ----805 ----831 ----836



Rustic 8651-8653

zamak / zamak / zamak / Zamak

| | C | L | W | H | D |
|---------|---|---|---|---|----|
| 8651--- | | | | | 35 |
| 8652--- | | | | | 30 |
| 8653--- | | | | | 25 |

acabado / finition / finish / Oberfläche

100 831 836 ----900

Clásico
Classique
Classic
Klassisch



Porcelana
P. 94

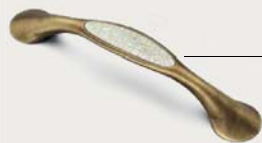

Porcelana 9821-9822

| | | | | | | | | | |
|------------------------------------------------------------------------|-----|-----|----|---|------------------------------------------|------|-----|------|-----|
| porcelana-zamak / porcelaine-zamak / porcelain-zamak / Porzellan-Zamak | | | | | acabado / finition / finish / Oberfläche | | | | |
| | C | L | W | H | D | ---- | 805 | ---- | 831 |
| 9821--- | 128 | 178 | 22 | | | | | | |
| 9822--- | 96 | 137 | 20 | | | | | | |



Porcelana 9770

| | | | | | | | | | | | | | |
|------------------------------------------------------------------------|----|-----|---|---|------------------------------------------|------|-----|------|-----|------|-----|------|-----|
| porcelana-zamak / porcelaine-zamak / porcelain-zamak / Porzellan-Zamak | | | | | acabado / finition / finish / Oberfläche | | | | | | | | |
| | C | L | W | H | D | ---- | 109 | ---- | 831 | ---- | 836 | ---- | 909 |
| 9770--- | 96 | 110 | | | 15 | | | | | | | | |



Porcelana 9831-9832

| | | | | | | | | | |
|------------------------------------------------------------------------|---|---|---|---|------------------------------------------|------|-----|------|-----|
| porcelana-zamak / porcelaine-zamak / porcelain-zamak / Porzellan-Zamak | | | | | acabado / finition / finish / Oberfläche | | | | |
| | C | L | W | H | D | ---- | 805 | ---- | 831 |
| 9831--- | | | | | 34 | | | | |
| 9832--- | | | | | 28 | | | | |



Porcelana 9771-9772

| | | | | | | | | | | | | | |
|------------------------------------------------------------------------|---|---|---|---|------------------------------------------|------|-----|------|-----|------|-----|------|-----|
| porcelana-zamak / porcelaine-zamak / porcelain-zamak / Porzellan-Zamak | | | | | acabado / finition / finish / Oberfläche | | | | | | | | |
| | C | L | W | H | D | ---- | 109 | ---- | 831 | ---- | 836 | ---- | 909 |
| 9771--- | | | | | 37 | | | | | | | | |
| 9772--- | | | | | 30 | | | | | | | | |



Porcelana 9841-9842

| | | | | | | | | | |
|------------------------------------------------------------------------|-----|-----|----|---|------------------------------------------|------|-----|--|--|
| porcelana-zamak / porcelaine-zamak / porcelain-zamak / Porzellan-Zamak | | | | | acabado / finition / finish / Oberfläche | | | | |
| | C | L | W | H | D | ---- | 831 | | |
| 9841--- | 128 | 178 | 22 | | | | | | |
| 9842--- | 96 | 137 | 20 | | | | | | |



Porcelana 9700

| | | | | | | | | | | | |
|------------------------------------------------------------------------|----|-----|---|---|------------------------------------------|------|-----|------|-----|------|-----|
| porcelana-zamak / porcelaine-zamak / porcelain-zamak / Porzellan-Zamak | | | | | acabado / finition / finish / Oberfläche | | | | | | |
| | C | L | W | H | D | ---- | 102 | ---- | 836 | ---- | 902 |
| 9700--- | 96 | 110 | | | 15 | | | | | | |



Porcelana 9851-9852

| | | | | | | | | | |
|------------------------------------------------------------------------|---|---|---|---|------------------------------------------|------|-----|--|--|
| porcelana-zamak / porcelaine-zamak / porcelain-zamak / Porzellan-Zamak | | | | | acabado / finition / finish / Oberfläche | | | | |
| | C | L | W | H | D | ---- | 831 | | |
| 9851--- | | | | | 34 | | | | |
| 9852--- | | | | | 28 | | | | |





Porcelana 9651-9652

porcelana / porcelaine / porcelain / Porzellan

acabado / finition / finish / Oberfläche

| | C | L | W | H | D | |
|---------|---|---|---|---|---|----|
| 9651--- | | | | | | 38 |
| 9652--- | | | | | | 32 |



Porcelana 9681-9682

porcelana / porcelaine / porcelain / Porzellan

acabado / finition / finish / Oberfläche

| | C | L | W | H | D | |
|---------|---|---|---|---|---|----|
| 9681--- | | | | | | 38 |
| 9682--- | | | | | | 32 |



Porcelana 9531-9533

porcelana-zamak / porcelaine-zamak / porcelain-zamak / Porzellan-Zamak

acabado / finition / finish / Oberfläche

| | C | L | W | H | D | |
|---------|---|---|---|---|---|----|
| 9531--- | | | | | | 37 |
| 9532--- | | | | | | 30 |
| 9533--- | | | | | | 25 |



Porcelana 9501-9502

porcelana-zamak / porcelaine-zamak / porcelain-zamak / Porzellan-Zamak

acabado / finition / finish / Oberfläche

| | C | L | W | H | D | |
|---------|---|---|---|---|---|----|
| 9501--- | | | | | | 37 |
| 9502--- | | | | | | 30 |



Porcelana 9551-9552

porcelana-zamak / porcelaine-zamak / porcelain-zamak / Porzellan-Zamak

acabado / finition / finish / Oberfläche

| | C | L | W | H | D | |
|---------|---|---|---|---|---|----|
| 9551--- | | | | | | 37 |
| 9552--- | | | | | | 30 |



Cristal 9991-9993

cristal-latón / cristal-laiton / crystal-brass / Kristall-Messing

acabado / finition / finish / Oberfläche

| | C | L | W | H | D | |
|---------|---|---|---|---|---|----|
| 9991--- | | | | | | 35 |
| 9992--- | | | | | | 30 |
| 9993--- | | | | | | 25 |



Cristal 9932-9933

cristal "strass"-latón / cristal "strass"-laiton / "strass" crystal-brass / "Strass" Kristall-Messing

acabado / finition / finish / Oberfläche

| | C | L | W | H | D | |
|---------|---|---|---|---|---|----|
| 9932--- | | | | | | 30 |
| 9933--- | | | | | | 20 |

1 Made with Swarovski® elements



Cristal 9952-9953

cristal "strass"-latón / cristal "strass"-laiton / "strass" crystal-brass / "Strass" Kristall-Messing

acabado / finition / finish / Oberfläche

| | C | L | W | H | D | |
|---------|---|---|---|---|---|----|
| 9952--- | | | | | | 30 |
| 9953--- | | | | | | 25 |

1 Made with Swarovski® elements



Cristal 9912-9913

cristal-latón / cristal-laiton / crystal-brass / Kristall-Messing

acabado / finition / finish / Oberfläche

| | C | L | W | H | D | |
|---------|---|---|---|---|---|----|
| 9912--- | | | | | | 30 |
| 9913--- | | | | | | 25 |



Cristal 9982-9983

cristal-latón / cristal-laiton / crystal-brass / Kristall-Messing

acabado / finition / finish / Oberfläche

| | C | L | W | H | D | |
|---------|---|---|---|---|---|----|
| 9982--- | | | | | | 30 |
| 9983--- | | | | | | 25 |





Infantil
Enfants
Children
Kinder



Junior
P. 101



Junior 5601

aluminio y resina poliéster / aluminium et résine polyester / aluminium and polyester resin / Aluminium und Polyesterharz

acabado / finition / finish / Oberfläche

| C | L | W | H | D |
|---------|----|----|----|---|
| 5601--- | 45 | 45 | 25 | |



Junior 5602

aluminio y resina poliéster / aluminium et résine polyester / aluminium and polyester resin / Aluminium und Polyesterharz

acabado / finition / finish / Oberfläche

| C | L | W | H | D |
|---------|----|----|----|---|
| 5602--- | 50 | 45 | 25 | |



Junior 5603

aluminio y resina poliéster / aluminium et résine polyester / aluminium and polyester resin / Aluminium und Polyesterharz

acabado / finition / finish / Oberfläche

| C | L | W | H | D |
|---------|----|----|----|---|
| 5603--- | 50 | 25 | 25 | |



Junior 5604

aluminio y resina poliéster / aluminium et résine polyester / aluminium and polyester resin / Aluminium und Polyesterharz

acabado / finition / finish / Oberfläche

| C | L | W | H | D |
|---------|----|----|----|---|
| 5604--- | 35 | 35 | 20 | |



Junior 5605

aluminio y resina poliéster / aluminium et résine polyester / aluminium and polyester resin / Aluminium und Polyesterharz

acabado / finition / finish / Oberfläche

| C | L | W | H | D |
|---------|----|----|----|---|
| 5605--- | 42 | 50 | 32 | |



Junior 5606

aluminio y resina poliéster / aluminium et résine polyester / aluminium and polyester resin / Aluminium und Polyesterharz

acabado / finition / finish / Oberfläche

| C | L | W | H | D |
|---------|----|----|----|---|
| 5606--- | 50 | 50 | 28 | |



Junior 5607

aluminio y resina poliéster / aluminium et résine polyester / aluminium and polyester resin / Aluminium und Polyesterharz

acabado / finition / finish / Oberfläche

| C | L | W | H | D |
|---------|----|----|----|---|
| 5607--- | 47 | 38 | 28 | |



Junior 5608

aluminio y resina poliéster / aluminium et résine polyester / aluminium and polyester resin / Aluminium und Polyesterharz

acabado / finition / finish / Oberfläche

| C | L | W | H | D |
|---------|----|----|----|---|
| 5608--- | 45 | 47 | 28 | |



KidLine 5611

| | | | | | | | | | |
|-------------------------------|----|----|---|---|------------------------------------------|-----|--|--|--|
| nylon / nylon / nylon / Nylon | | | | | acabado / finition / finish / Oberfläche | | | | |
| C | L | W | H | D | ---- | 000 | | | |
| 5611--- | 40 | 40 | | | | | | | |



KidLine 5612

| | | | | | | | | | |
|-------------------------------|----|----|---|---|------------------------------------------|-----|--|--|--|
| nylon / nylon / nylon / Nylon | | | | | acabado / finition / finish / Oberfläche | | | | |
| C | L | W | H | D | ---- | 000 | | | |
| 5612--- | 40 | 40 | | | | | | | |



KidLine 5613

| | | | | | | | | | |
|-------------------------------|----|----|---|---|------------------------------------------|-----|--|--|--|
| nylon / nylon / nylon / Nylon | | | | | acabado / finition / finish / Oberfläche | | | | |
| C | L | W | H | D | ---- | 000 | | | |
| 5613--- | 43 | 43 | | | | | | | |



KidLine 5614

| | | | | | | | | | |
|-------------------------------|---|---|---|----|------------------------------------------|-----|--|--|--|
| nylon / nylon / nylon / Nylon | | | | | acabado / finition / finish / Oberfläche | | | | |
| C | L | W | H | D | ---- | 000 | | | |
| 5614--- | | | | 50 | | | | | |



KidLine 5615

| | | | | | | | | | |
|-------------------------------|----|----|---|---|------------------------------------------|-----|--|--|--|
| nylon / nylon / nylon / Nylon | | | | | acabado / finition / finish / Oberfläche | | | | |
| C | L | W | H | D | ---- | 000 | | | |
| 5615--- | 47 | 51 | | | | | | | |



KidLine 5616

| | | | | | | | | | |
|-------------------------------|---|---|---|----|------------------------------------------|-----|--|--|--|
| nylon / nylon / nylon / Nylon | | | | | acabado / finition / finish / Oberfläche | | | | |
| C | L | W | H | D | ---- | 000 | | | |
| 5616--- | | | | 50 | | | | | |



KidLine 5617

| | | | | | | | | | |
|-------------------------------|---|---|---|----|------------------------------------------|-----|--|--|--|
| nylon / nylon / nylon / Nylon | | | | | acabado / finition / finish / Oberfläche | | | | |
| C | L | W | H | D | ---- | 000 | | | |
| 5617--- | | | | 50 | | | | | |



KidLine 5618

| | | | | | | | | | |
|-------------------------------|----|----|---|---|------------------------------------------|-----|--|--|--|
| nylon / nylon / nylon / Nylon | | | | | acabado / finition / finish / Oberfläche | | | | |
| C | L | W | H | D | ---- | 000 | | | |
| 5618--- | 50 | 48 | | | | | | | |



KidLine 5619

| | | | | | | | | | |
|-------------------------------|---|---|---|----|------------------------------------------|-----|--|--|--|
| nylon / nylon / nylon / Nylon | | | | | acabado / finition / finish / Oberfläche | | | | |
| C | L | W | H | D | ---- | 000 | | | |
| 5619--- | | | | 50 | | | | | |



KidLine 5621

| | | | | | | | | | |
|-------------------------------|----|----|---|---|------------------------------------------|-----|--|--|--|
| nylon / nylon / nylon / Nylon | | | | | acabado / finition / finish / Oberfläche | | | | |
| C | L | W | H | D | ---- | 000 | | | |
| 5621--- | 44 | 41 | | | | | | | |



KidLine 5622

| | | | | | | | | | |
|-------------------------------|----|----|---|---|------------------------------------------|-----|--|--|--|
| nylon / nylon / nylon / Nylon | | | | | acabado / finition / finish / Oberfläche | | | | |
| C | L | W | H | D | ---- | 000 | | | |
| 5622--- | 38 | 47 | | | | | | | |



KidLine 5623

| | | | | | | | | | |
|-------------------------------|----|----|---|---|------------------------------------------|-----|--|--|--|
| nylon / nylon / nylon / Nylon | | | | | acabado / finition / finish / Oberfläche | | | | |
| C | L | W | H | D | ---- | 000 | | | |
| 5623--- | 35 | 58 | | | | | | | |



KidLine 5624

| | | | | | | | | | |
|-------------------------------|----|----|---|---|------------------------------------------|-----|--|--|--|
| nylon / nylon / nylon / Nylon | | | | | acabado / finition / finish / Oberfläche | | | | |
| C | L | W | H | D | ---- | 000 | | | |
| 5624--- | 45 | 42 | | | | | | | |



KidLine 5625

| | | | | | | | | | |
|-------------------------------|----|----|---|---|------------------------------------------|-----|--|--|--|
| nylon / nylon / nylon / Nylon | | | | | acabado / finition / finish / Oberfläche | | | | |
| C | L | W | H | D | ---- | 000 | | | |
| 5625--- | 51 | 35 | | | | | | | |



KidLine 5626

| | | | | | | | | | |
|-------------------------------|----|----|---|---|------------------------------------------|-----|--|--|--|
| nylon / nylon / nylon / Nylon | | | | | acabado / finition / finish / Oberfläche | | | | |
| C | L | W | H | D | ---- | 000 | | | |
| 5626--- | 34 | 49 | | | | | | | |



KidLine 5627

| | | | | | | | | | |
|-------------------------------|----|----|---|---|------------------------------------------|-----|--|--|--|
| nylon / nylon / nylon / Nylon | | | | | acabado / finition / finish / Oberfläche | | | | |
| C | L | W | H | D | ---- | 000 | | | |
| 5627--- | 50 | 35 | | | | | | | |



KidLine 5628

| | | | | | | | | | |
|-------------------------------|----|----|---|---|------------------------------------------|-----|--|--|--|
| nylon / nylon / nylon / Nylon | | | | | acabado / finition / finish / Oberfläche | | | | |
| C | L | W | H | D | ---- | 000 | | | |
| 5628--- | 50 | 31 | | | | | | | |



KidLine 5629

| | | | | | | | | | |
|-------------------------------|----|----|---|---|------------------------------------------|-----|--|--|--|
| nylon / nylon / nylon / Nylon | | | | | acabado / finition / finish / Oberfläche | | | | |
| C | L | W | H | D | ---- | 000 | | | |
| 5629--- | 23 | 51 | | | | | | | |

Complementos & Accesorios

Compléments & Accessoires

Complements & Accessories

Ergänzungen & Zubehör



Diábolo
P. 106



Diábolo 2880

zamak / zamak / zamak / Zamak

| 2880--- | C | L | W | H | D |
|---------|---|---|---|----|----|
| | | | | 35 | 60 |

acabado / finition / finish / Oberfläche

| | | | | | | | | | | | |
|------|-----|------|-----|------|-----|------|-----|------|-----|------|-----|
| ---- | 032 | ---- | 038 | ---- | 292 | ---- | 400 | ---- | 800 | ---- | 831 |
|------|-----|------|-----|------|-----|------|-----|------|-----|------|-----|



Jaws 2870

zamak / zamak / zamak / Zamak

| 2870--- | C | L | W | H | D |
|---------|----|-----|----|------|---|
| | 24 | 104 | 69 | 59,2 | |

acabado / finition / finish / Oberfläche

| | | | |
|------|-----|------|-----|
| ---- | 038 | ---- | 800 |
|------|-----|------|-----|



Grip 2211-2212

zamak / zamak / zamak / Zamak

| | C | L | W | H | D |
|---------|-----|-----|----|----|---|
| 2211--- | 300 | 317 | 25 | 52 | |
| 2212--- | 200 | 217 | 25 | 48 | |

acabado / finition / finish / Oberfläche

----038 ----400

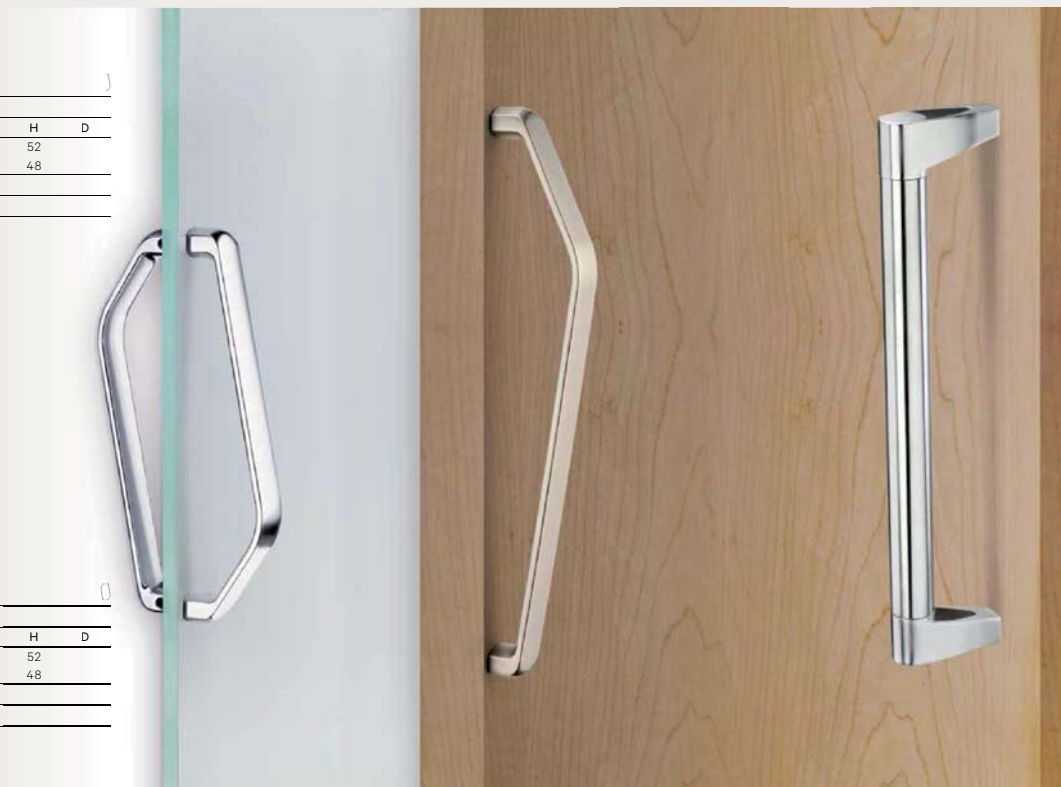

Grip Duo 2111-2112

zamak / zamak / zamak / Zamak

| | C | L | W | H | D |
|---------|-----|-----|----|----|---|
| 2111--- | 300 | 317 | 25 | 52 | |
| 2112--- | 200 | 217 | 25 | 48 | |

acabado / finition / finish / Oberfläche

----038 ----400

Bar 2201-2202

acero inoxidable / acier inox / stainless steel / Rostfreier Stahl

| | C | L | W | H | D |
|---------|-----|-----|----|----|---|
| 2201--- | 300 | 315 | 25 | 65 | |
| 2202--- | 200 | 215 | 25 | 65 | |

acabado / finition / finish / Oberfläche

----031



Bar Duo 2101-2102

acero inoxidable / acier inox / stainless steel / Rostfreier Stahl

| | C | L | W | H | D |
|---------|-----|-----|----|----|---|
| 2101--- | 300 | 315 | 25 | 65 | |
| 2102--- | 200 | 215 | 25 | 65 | |

acabado / finition / finish / Oberfläche

----031

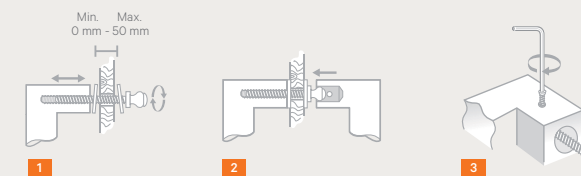

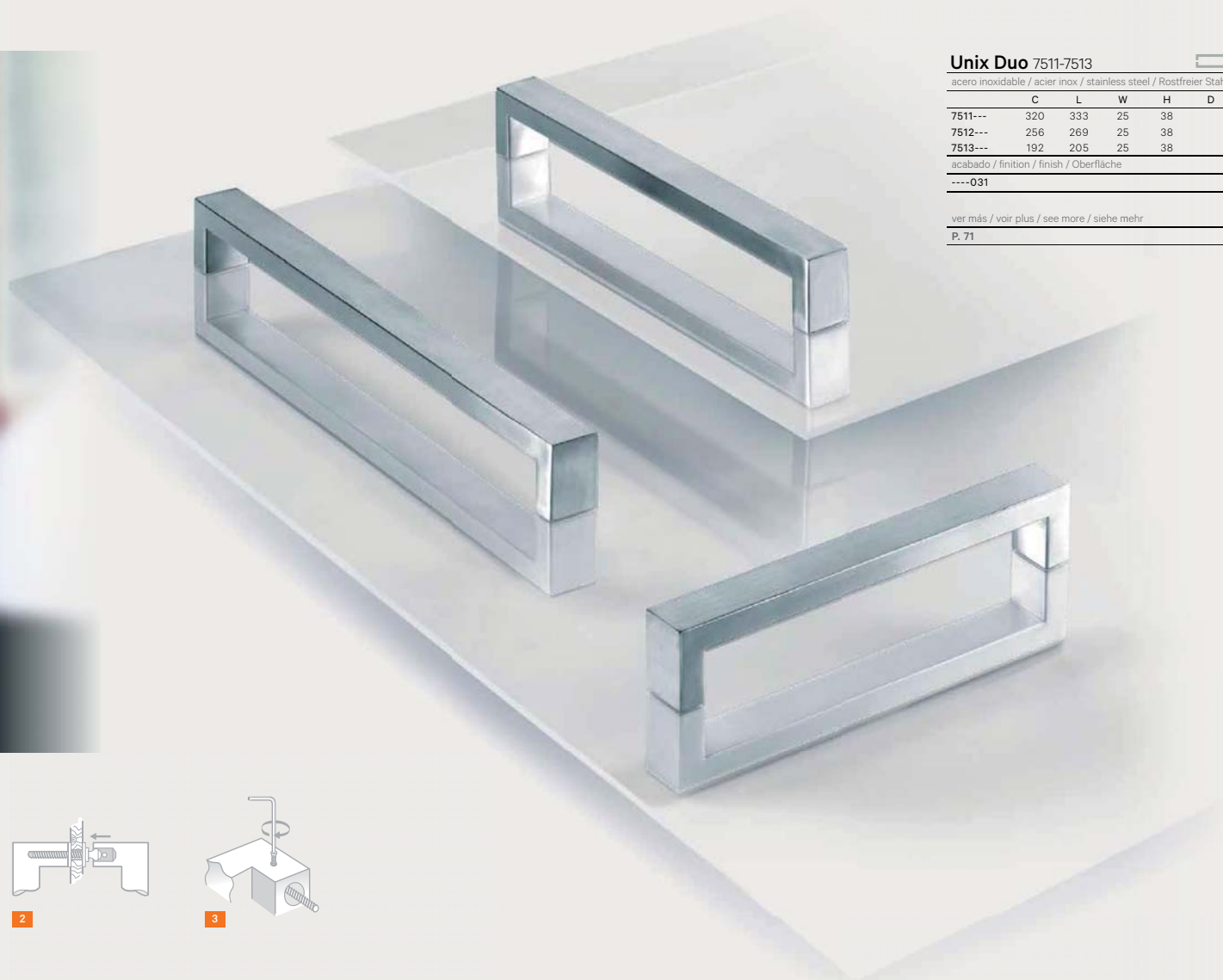

Unix Duo 7511-7513

acero inoxidable / acier inox / stainless steel / Rostfreier Stahl

| | C | L | W | H | D |
|---------|-----|-----|----|----|---|
| 7511--- | 320 | 333 | 25 | 38 | |
| 7512--- | 256 | 269 | 25 | 38 | |
| 7513--- | 192 | 205 | 25 | 38 | |

acabado / finition / finish / Oberfläche

----031

ver más / voir plus / see more / siehe mehr

P. 71

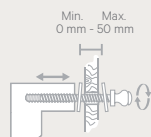

1

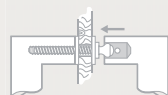

2



3

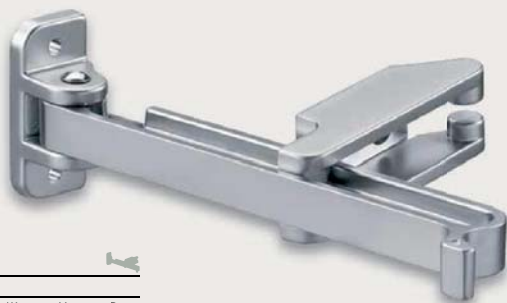

Bolt 2000

zamak / zamak / zamak / Zamak

| | C | L | W | H | D |
|------------------------------------------|-----|-----|-----|-----|-----|
| 2000--- | | 140 | | | |
| acabado / finition / finish / Oberfläche | | | | | |
| ---- | 100 | 200 | 400 | 800 | 900 |



Slide 2840

zamak / zamak / zamak / Zamak

| | C | L | W | H | D |
|------------------------------------------|-----|-----|-----|---|---|
| 2840--- | | 54 | 44 | | |
| acabado / finition / finish / Oberfläche | | | | | |
| ---- | 038 | 400 | 800 | | |



Slide 2850

zamak / zamak / zamak / Zamak

| | C | L | W | H | D |
|------------------------------------------|-----|-----|-----|---|---|
| 2850--- | | 55 | 49 | | |
| acabado / finition / finish / Oberfläche | | | | | |
| ---- | 038 | 400 | 800 | | |



Colgador 2810

zamak / zamak / zamak / Zamak

| | C | L | W | H | D |
|------------------------------------------|-----|-----|-----|---|---|
| 2810--- | | 70 | 70 | | |
| acabado / finition / finish / Oberfläche | | | | | |
| ---- | 100 | 400 | 500 | | |



Slide 2860

zamak / zamak / zamak / Zamak

| | C | L | W | H | D |
|------------------------------------------|-----|-----|-----|---|---|
| 2860--- | | 56 | 25 | | |
| acabado / finition / finish / Oberfläche | | | | | |
| ---- | 038 | 400 | 800 | | |



Los colgadores individuales poseen una efectiva y fácil manera de fijación.
 Les portemanteaux individuels incorporent un système de fixation simple et efficace.
 Individual hangers grant an easy and effective fixing system.
 Die Einzelkleiderhaken verfügen über ein einfaches und wirksames Befestigungssystem.

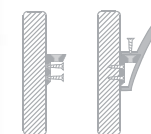



Icons 1101

acero inoxidable / acier inox / stainless steel / Rostfreier Stahl acabado / finition / finish / Oberfläche

| | C | L | W | H | D |
|---------|---|-----|-----|---|---|
| 1101--- | | 100 | 100 | 2 | |



Icons 1102

acero inoxidable / acier inox / stainless steel / Rostfreier Stahl acabado / finition / finish / Oberfläche

| | C | L | W | H | D |
|---------|---|-----|-----|---|---|
| 1102--- | | 100 | 100 | 2 | |



Icons 1103

acero inoxidable / acier inox / stainless steel / Rostfreier Stahl acabado / finition / finish / Oberfläche

| | C | L | W | H | D |
|---------|---|-----|-----|---|---|
| 1103--- | | 100 | 100 | 2 | |

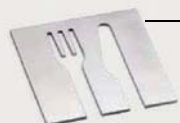

Icons 1104

acero inoxidable / acier inox / stainless steel / Rostfreier Stahl acabado / finition / finish / Oberfläche

| | C | L | W | H | D |
|---------|---|-----|-----|---|---|
| 1104--- | | 100 | 100 | 2 | |



Icons 1105

acero inoxidable / acier inox / stainless steel / Rostfreier Stahl acabado / finition / finish / Oberfläche

| | C | L | W | H | D |
|---------|---|-----|-----|---|---|
| 1105--- | | 100 | 100 | 2 | |



Instalación con cinta adhesiva de doble cara incluida en el blister.
 Installation avec ruban adhésif double-face inclu dans le blister.
 Installation with double sided adhesive tape included in blister.
 Montage mittels doppelseitigem Klebeband, im Blister enthalten.



Icons 1106

acero inoxidable / acier inox / stainless steel / Rostfreier Stahl acabado / finition / finish / Oberfläche

| | C | L | W | H | D |
|---------|---|-----|-----|---|---|
| 1106--- | | 100 | 100 | 2 | |



Icons 1107

acero inoxidable / acier inox / stainless steel / Rostfreier Stahl acabado / finition / finish / Oberfläche

| | C | L | W | H | D |
|---------|---|-----|-----|---|---|
| 1107--- | | 100 | 100 | 2 | |



Icons 1108

acero inoxidable / acier inox / stainless steel / Rostfreier Stahl acabado / finition / finish / Oberfläche

| | C | L | W | H | D |
|---------|---|-----|-----|---|---|
| 1108--- | | 100 | 100 | 2 | |



Icons 1109

acero inoxidable / acier inox / stainless steel / Rostfreier Stahl acabado / finition / finish / Oberfläche

| | C | L | W | H | D |
|---------|---|-----|-----|---|---|
| 1109--- | | 100 | 100 | 2 | |





Icons 1000-1020

| acero inoxidable / acier inox / stainless steel / Rostfreier Stahl | | | | | acabado / finition / finish / Oberfläche |
|--------------------------------------------------------------------|---|-----|---|---|------------------------------------------|
| C | L | W | H | D | ----031 |
| 1000--- | | 125 | 2 | | |
| 1020--- | | 75 | 2 | | |

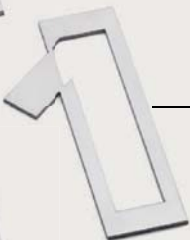

Icons 1001-1021

| acero inoxidable / acier inox / stainless steel / Rostfreier Stahl | | | | | acabado / finition / finish / Oberfläche |
|--------------------------------------------------------------------|---|-----|---|---|------------------------------------------|
| C | L | W | H | D | ----031 |
| 1001--- | | 125 | 2 | | |
| 1021--- | | 75 | 2 | | |



Icons 1002-1022

| acero inoxidable / acier inox / stainless steel / Rostfreier Stahl | | | | | acabado / finition / finish / Oberfläche |
|--------------------------------------------------------------------|---|-----|---|---|------------------------------------------|
| C | L | W | H | D | ----031 |
| 1002--- | | 125 | 2 | | |
| 1022--- | | 75 | 2 | | |



Icons 1003-1023

| acero inoxidable / acier inox / stainless steel / Rostfreier Stahl | | | | | acabado / finition / finish / Oberfläche |
|--------------------------------------------------------------------|---|-----|---|---|------------------------------------------|
| C | L | W | H | D | ----031 |
| 1003--- | | 125 | 2 | | |
| 1023--- | | 75 | 2 | | |

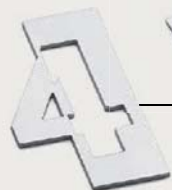

Icons 1004-1024

| acero inoxidable / acier inox / stainless steel / Rostfreier Stahl | | | | | acabado / finition / finish / Oberfläche |
|--------------------------------------------------------------------|---|-----|---|---|------------------------------------------|
| C | L | W | H | D | ----031 |
| 1004--- | | 125 | 2 | | |
| 1024--- | | 75 | 2 | | |



Icons 1005-1025

| acero inoxidable / acier inox / stainless steel / Rostfreier Stahl | | | | | acabado / finition / finish / Oberfläche |
|--------------------------------------------------------------------|---|-----|---|---|------------------------------------------|
| C | L | W | H | D | ----031 |
| 1005--- | | 125 | 2 | | |
| 1025--- | | 75 | 2 | | |



Icons 1006-1026

| acero inoxidable / acier inox / stainless steel / Rostfreier Stahl | | | | | acabado / finition / finish / Oberfläche |
|--------------------------------------------------------------------|---|-----|---|---|------------------------------------------|
| C | L | W | H | D | ----031 |
| 1006--- | | 125 | 2 | | |
| 1026--- | | 75 | 2 | | |

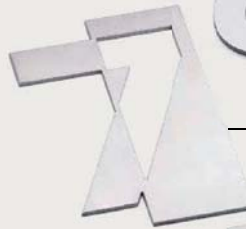

Icons 1007-1027

| acero inoxidable / acier inox / stainless steel / Rostfreier Stahl | | | | | acabado / finition / finish / Oberfläche |
|--------------------------------------------------------------------|---|-----|---|---|------------------------------------------|
| C | L | W | H | D | ----031 |
| 1007--- | | 125 | 2 | | |
| 1027--- | | 75 | 2 | | |

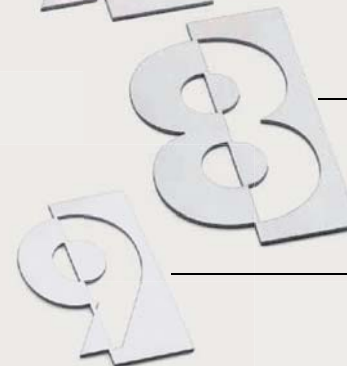

Icons 1008-1028

| acero inoxidable / acier inox / stainless steel / Rostfreier Stahl | | | | | acabado / finition / finish / Oberfläche |
|--------------------------------------------------------------------|---|-----|---|---|------------------------------------------|
| C | L | W | H | D | ----031 |
| 1008--- | | 125 | 2 | | |
| 1028--- | | 75 | 2 | | |

Icons 1009-1029

| acero inoxidable / acier inox / stainless steel / Rostfreier Stahl | | | | | acabado / finition / finish / Oberfläche |
|--------------------------------------------------------------------|---|-----|---|---|------------------------------------------|
| C | L | W | H | D | ----031 |
| 1009--- | | 125 | 2 | | |
| 1029--- | | 75 | 2 | | |



En blister packs con elementos de fijación incluidos.
 Dans des blisters, tous les éléments de fixation inclus.
 In blisters, all fitting elements included.
 In Blisterverpackung, Befestigungselemente eingeschlossen.

Instalación con cinta adhesiva de doble cara incluida en el blister.
 Installation avec ruban adhésif double-face inclus dans le blister.
 Installation with double sided adhesive tape included in blister.
 Montage mittels doppelseitigem Klebeband, im Blister enthalten.



Montaje para números de 125mm
 Montage pour numéros de 125mm
 Set up for numbers 125mm
 Befestigungsanleitung von Ziffern in 125mm

Icons 1030

| | | | | | |
|--------------------------------------------------------------------|----|----|---|---|------------------------------------------|
| acero inoxidable / acier inox / stainless steel / Rostfreier Stahl | | | | | acabado / finition / finish / Oberfläche |
| C | L | W | H | D | ----031 |
| 1030--- | 20 | 10 | 2 | | |

Icons 102A

| | | | | | |
|--------------------------------------------------------------------|----|---|---|---|------------------------------------------|
| acero inoxidable / acier inox / stainless steel / Rostfreier Stahl | | | | | acabado / finition / finish / Oberfläche |
| C | L | W | H | D | ----031 |
| 102A--- | 75 | 2 | | | |

Icons 102B

| | | | | | |
|--------------------------------------------------------------------|----|---|---|---|------------------------------------------|
| acero inoxidable / acier inox / stainless steel / Rostfreier Stahl | | | | | acabado / finition / finish / Oberfläche |
| C | L | W | H | D | ----031 |
| 102B--- | 75 | 2 | | | |

Icons 102C

| | | | | | |
|--------------------------------------------------------------------|----|---|---|---|------------------------------------------|
| acero inoxidable / acier inox / stainless steel / Rostfreier Stahl | | | | | acabado / finition / finish / Oberfläche |
| C | L | W | H | D | ----031 |
| 102C--- | 75 | 2 | | | |

Icons 102D

| | | | | | |
|--------------------------------------------------------------------|----|---|---|---|------------------------------------------|
| acero inoxidable / acier inox / stainless steel / Rostfreier Stahl | | | | | acabado / finition / finish / Oberfläche |
| C | L | W | H | D | ----031 |
| 102D--- | 75 | 2 | | | |

Icons 102E

| | | | | | |
|--------------------------------------------------------------------|----|---|---|---|------------------------------------------|
| acero inoxidable / acier inox / stainless steel / Rostfreier Stahl | | | | | acabado / finition / finish / Oberfläche |
| C | L | W | H | D | ----031 |
| 102E--- | 75 | 2 | | | |



**Tornillo multilargo
Vis multilongueur
Multisize screw
Multilängen-Schrauben**

| | | | | | |
|-----------------------------|---------|---|---|---|------------------------------------------|
| hierro / fer / iron / Eisen | | | | | acabado / finition / finish / Oberfläche |
| C | L | W | H | D | Zincado / Zingué / Zinc / Verzinkt |
| M-45 | 20 - 45 | | | 9 | |

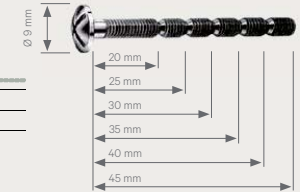

Tornillo multilargo de corte limpio que siempre rosca. Nuestros herrajes Estamp llevan incorporados este tipo de tornillo. Vis multilongueur qui se coupe facilement sans abîmer le filetage. Nos articles Estamp portent tous ce type de vis. Multisize screw clean cut that always screws. Our Estamp fittings include this kind of screw. Multilängenschraube immer gängig dank dem sauberen gewindeschnitt. Unsere Estamp Möbelbeschläge werden mit diesem Schraubentyp geliefert.

- ✓ **Reduzca la inversión**
En inmobilizado y el riesgo de restos invendibles sustituyendo los tornillos de diversas longitudes por el tornillo multilargo Estamp.
- ✓ **Reduisez l'investissement**
Des stocks immobilisés et le risque d'invendus en remplaçant les vis de différentes longueurs par une seule vis multilongueur Estamp.
- ✓ **Reduce investment**
In stocks and risk of not saleable rests substituting screws of different lengths with Estamp multisize screw.
- ✓ **Reduzieren sie Ihre Investitionen**
In Anlagen und vermeiden Sie das Risiko, auf unverkäuflichen Resten sitzen zu bleiben. Verwenden Sie anstatt Schrauben verschiedener Längen die Estamp Multilängen-schraube.
- ✓ **Reduzca espacio**
De almacenaje manteniendo en stock una sola longitud de tornillo.
- ✓ **Reduisez le volume**
De stockage en disposant d'une seule longueur de vis.
- ✓ **Reduce Space**
For storage keeping only one length of screw.
- ✓ **Geringerer Lager-Platzbedarf**
Dank einer einzigen Schraubenlänge.
- ✓ **Reduzca el gasto**
En mano de obra eliminando el limado de espárragos tradicionales al utilizar el tornillo multilargo Estamp de corte limpio y roscado directo.
- ✓ **Reduisez les frais**
De main-d'oeuvre pour le limage des tiges traditionnelles en utilisant la vis Estamp multilongueur de coupe facile et directe vis.
- ✓ **Reduce expenses**
On labour eliminating filing of traditional screw by using multisize Estamp screws of clean cut and direct screw.
- ✓ **Reduzieren sie Ihre Lohkosten**
Die sauber geschrittene, direktgängige Estamp Multilängenschraube macht das herkömmliche Steh-schraubenfeilen überflüssig.
- ✓ **Adaptable**
A los gruesos de madera utilizados en carpintería y ebanistería. Nuestros herrajes Estamp llevan incorporados este tipo de tornillo.
- ✓ **Adaptable**
À toutes les épaisseurs de bois utilisés en menuiserie et en ébénisterie. Nos articles Estamp portent tous ce type de vis.
- ✓ **Adaptable**
To different thicknesses of wood used in carpentry and woodwork industry. Our fittings Estamp are fitted with this kind of screw.
- ✓ **Anpassungsfähig**
Für alle in der Tischlerei und Schreinerei gebräuchlichen Holzdicken geeignet. Unsere Estamp Möbelbeschläge werden mit diesem Schraubentyp geliefert.

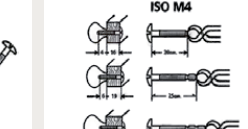

Cierres a presión Fermetures à pression Pressure locks Druckverschlüsse 231-232

nylon / nylon / nylon / Nylon

acabado / finition / finish / Oberfläche

- 231** Para puertas grandes / Pour grandes portes / For large doors / Für grosse Türen
- 232** Para puertas pequeñas / Pour petites portes / For small doors / Für kleine Türen



Tornillos Vis Screws Schrauben

hierro / fer / iron / Eisen

acabado / finition / finish / Oberfläche

Bicromatado / Bichromaté / Zinc-yellow / Bichromatiert

| | C | L | W | H | D |
|------|---|----|---|---|---|
| T-14 | | 14 | | | 9 |
| T-21 | | 21 | | | 9 |
| T-25 | | 25 | | | 9 |
| T-31 | | 31 | | | 9 |
| T-35 | | 35 | | | 9 |
| T-40 | | 40 | | | 9 |
| T-60 | | 60 | | | 9 |



Espárrago rosca madera Tiges filetées pour bois Wood screw Gewindeschraube für Holz

hierro / fer / iron / Eisen

acabado / finition / finish / Oberfläche

Bicromatado / Bichromaté / Zinc-yellow / Bichromatiert

| | C | L | W | H | D |
|-------|---|----|---|---|---|
| ED-15 | | 22 | | | |



Índice de acabados / Index des finitions / Index of finishes / Verzeichnis der Oberflächen

Los más utilizados Les plus utilisés The most used Meistverwendet

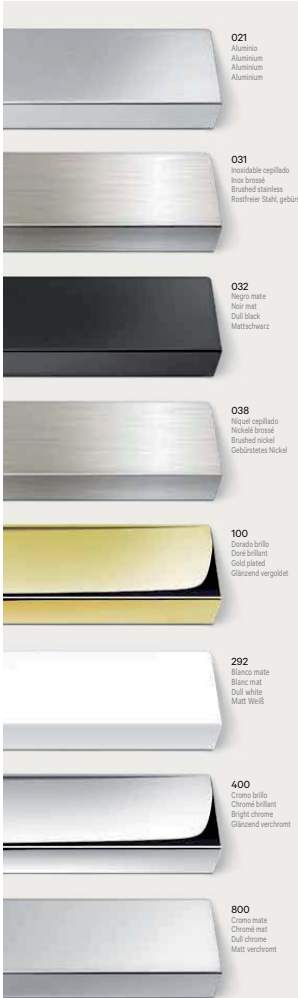

Otros acabados Autres finitions Other finishes Andere Oberflächen

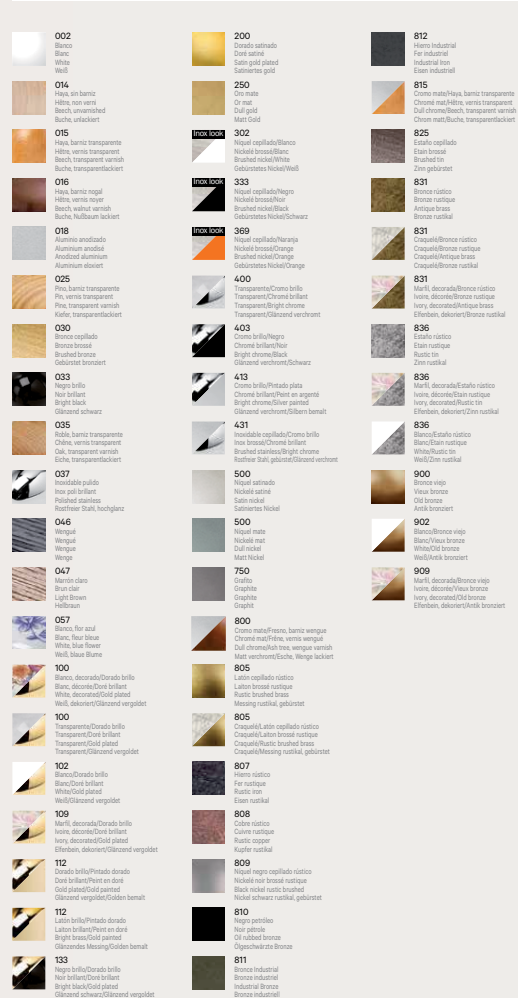

Información sobre los acabados
Informations sur les finitions
Information on the finishes
Information zu den Oberflächen

Los acabados mostrados en este catálogo son aproximados e ilustrativos y pueden variar ligeramente del color real.

Les finitions montrées dans ce catalogue sont approximées et illustratives et elles peuvent varier légèrement de la couleur réelle.

The finishes displayed in this catalogue are approximate and illustrative and may vary slightly from the actual colour.

Die in diesem Katalog gezeigten Oberflächen sind ungefähre Angaben und können von der tatsächlichen Farbe abweichen.



www.verges.com

J.JOSÉ VERGÉS S.A.
1 9 2 8

C. Joan XXIII, 20-26
08950 ESPLUGUES DE LLOBREGAT
(Barcelona, Spain)

Tel. Nacional 933 713 954*
Fax Nacional 933 725 302
Tel. Internat. 34-933 713 958*
Fax Internat. 34-933 725 302
E-Mail: estamp@verges.com

