



**HERRAJES**  
DE **ANDALUCÍA**

**Bonaiti**  
SERRATURE

## CERRADURAS MAGNÉTICAS Y MECÁNICAS



Cerradura Smart, B-Spilt, B-Two, B-No Ha y Accesorios



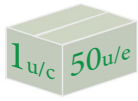

CÓDIGO	ACABADO
37451	CM
37452	LP
37453	CIM
37454	CR
37455	BL

### Cerradura Magnética

- Cajeadado compatible con Cerradura Mecánica B-Split
- Puede montarse cualquier tipo de roseta.
- Adaptable a cualquier manilla, independientemente del peso.

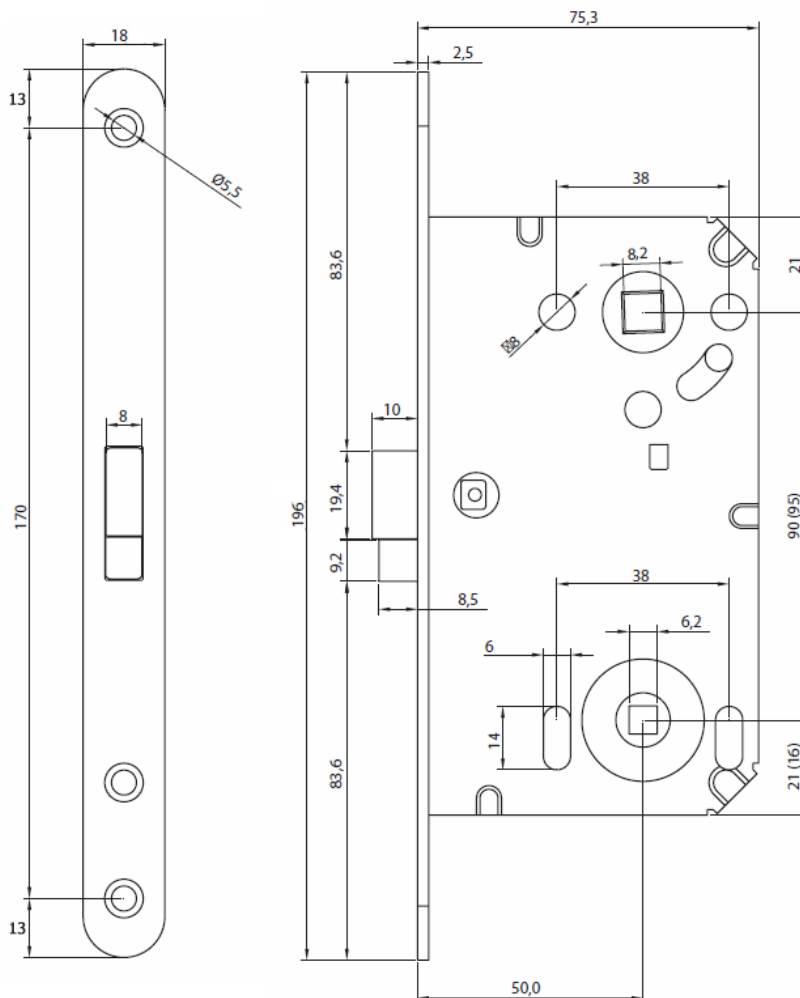



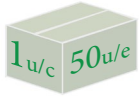

CÓDIGO	ACABADO
37456	CM
37457	LP
37458	CIM
37459	CR
37460	BL

### Cerradura Magnética

- Cajeadado compatible con Cerradura Mecánica B-Split
- Puede montarse cualquier tipo de roseta.
- Adaptable a cualquier manilla, independientemente del peso.

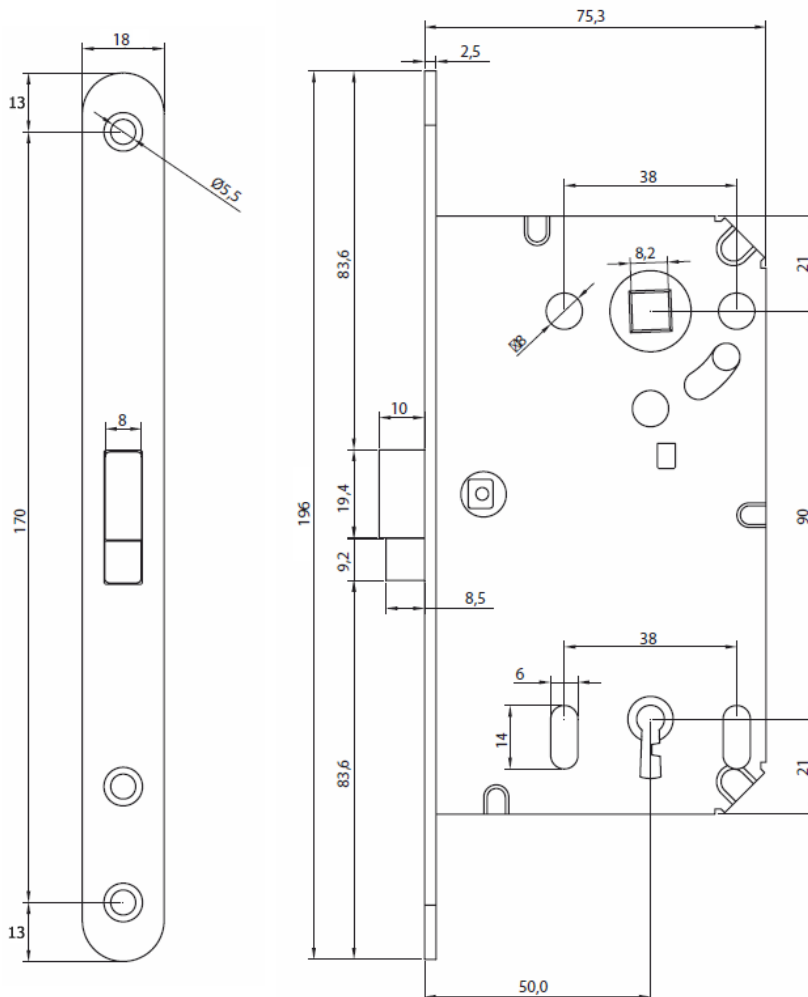
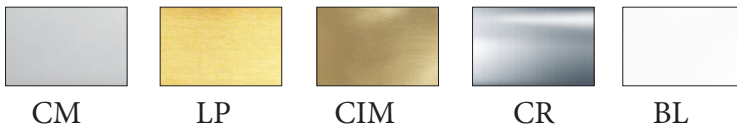

## Frontal Cajetín B-Smart



CÓDIGO ACABADO

37472 CM

37473 LP

37474 CIM

37475 CR

37476 BL

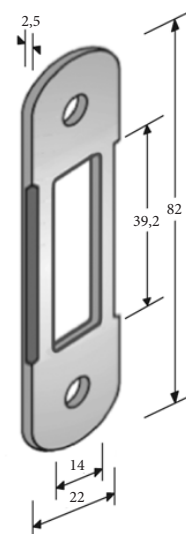

## Cajetín Magnético ABS B-Smart



CÓDIGO ACABADO

37471 Gris

37470 NE

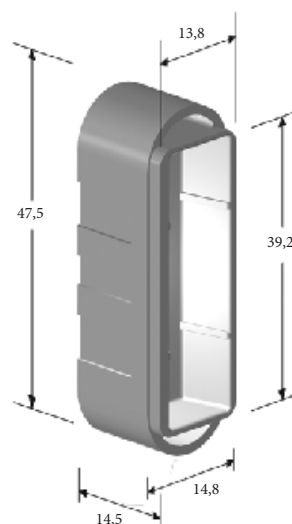
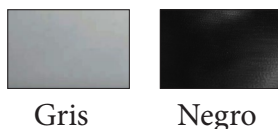

## Cerradero Magnético ABS B-Smart

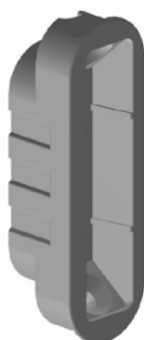

CÓDIGO ACABADO

37466 CM

37467 LP

37469 NE

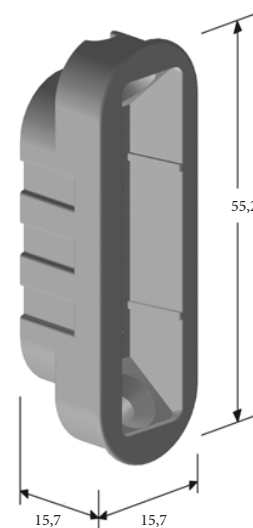
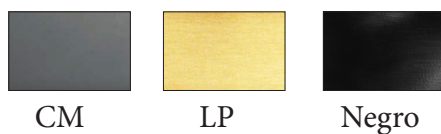

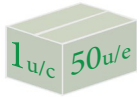

CÓDIGO	ACABADO
37477	CM
37478	LP
37479	CIM

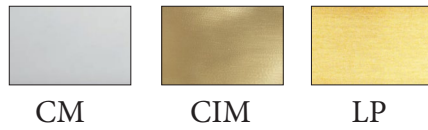

### Cerradura Mecánica

- Cajado compatible con Cerradura Magnética B-Smart
- Puede montarse cualquier tipo de roseta.
- Adaptable a cualquier manilla, independientemente del peso.

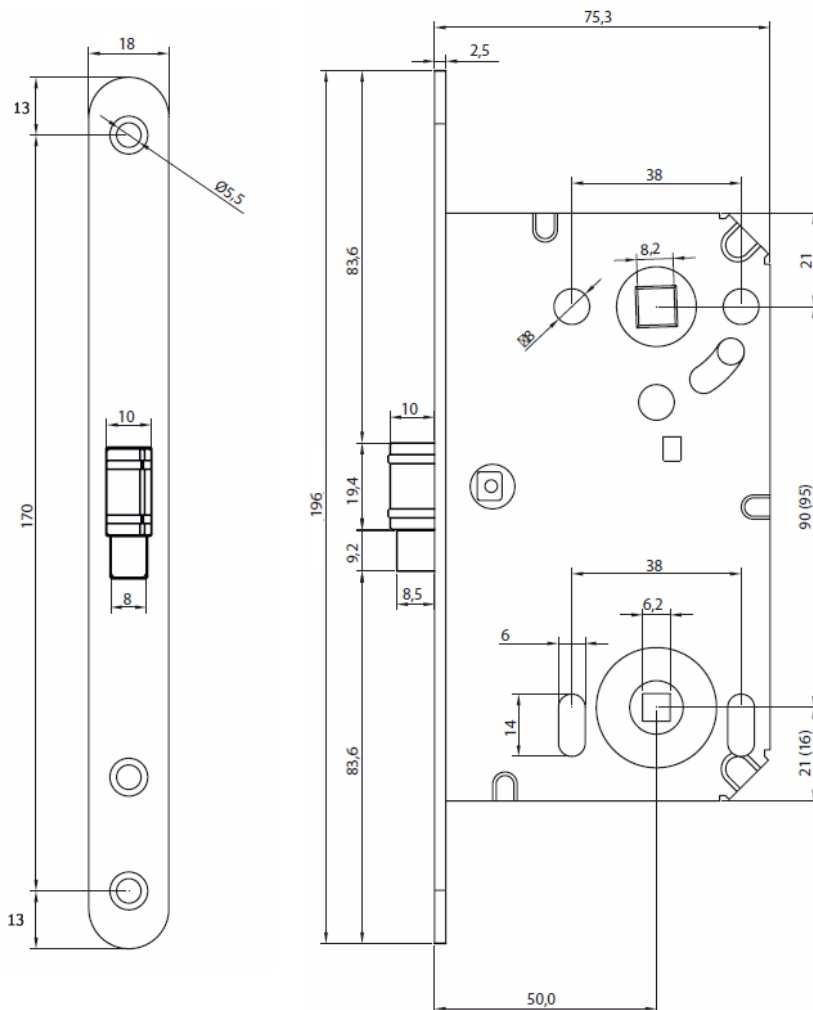



**CÓDIGO ACABADO**

37483	CM
37484	LP
37485	CIM

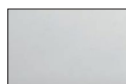

CM



CIM

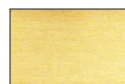

LP

**Cerradura Mecánica**

- Cajeadado compatible con Cerradura Magnética B-Smart
- Puede montarse cualquier tipo de roseta.
- Adaptable a cualquier manilla, independientemente del peso.

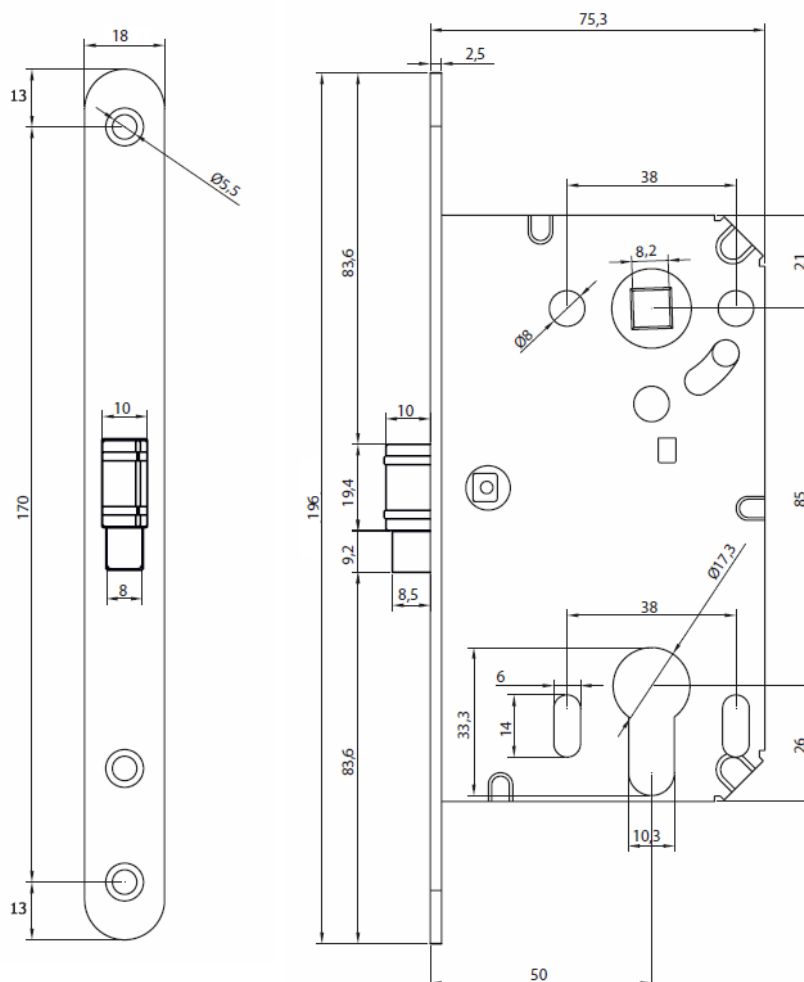

**CÓDIGO ACABADO**

37480	CM
37481	LP
37482	CIM

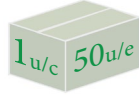

CM



CIM



LP



**Cerradura Mecánica**

- Cajeadado compatible con Cerradura Magnética B-Smart
- Puede montarse cualquier tipo de roseta.
- Adaptable a cualquier manilla, independientemente del peso.

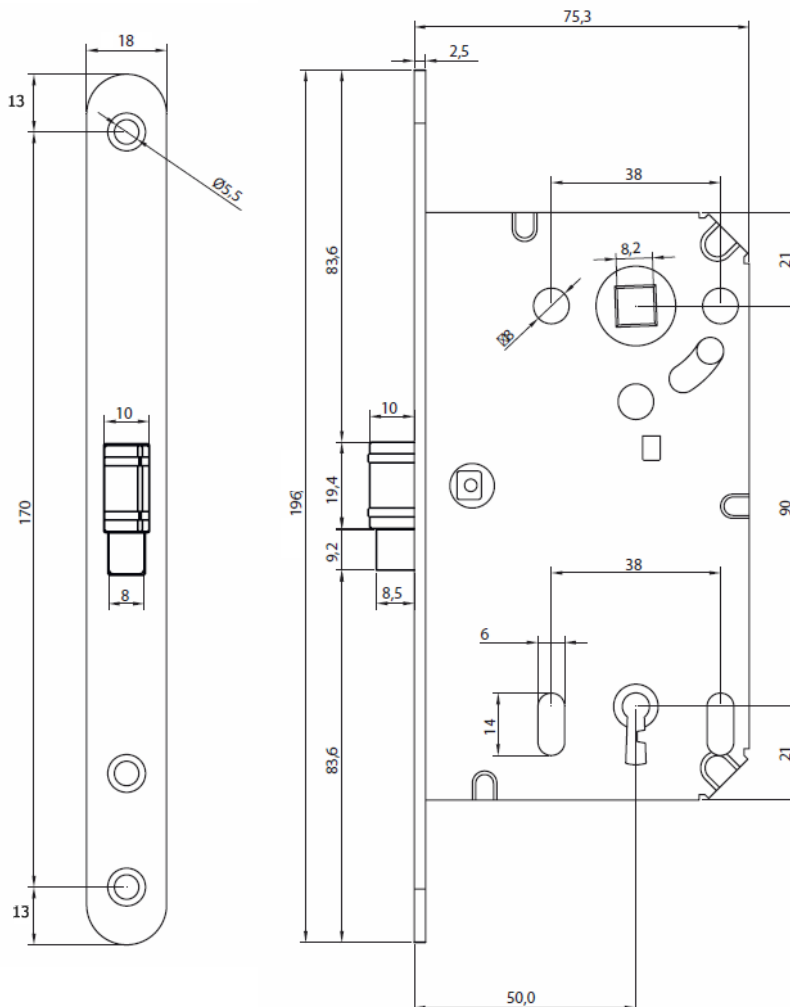



## Frontal Cajetín B-Split



CÓDIGO	ACABADO
37472	CM
37473	LP
37474	CIM
37475	CR
37476	BL

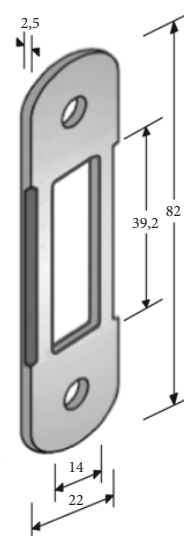

## Frontal Cajetín Ala B-Smart



CÓDIGO	ACABADO
37488	CM
37489	LT
37490	CIM

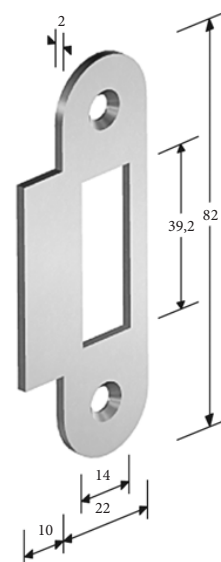

## Cajetín ABS B-Split



CÓDIGO	ACABADO
37486	NE
37487	Gris

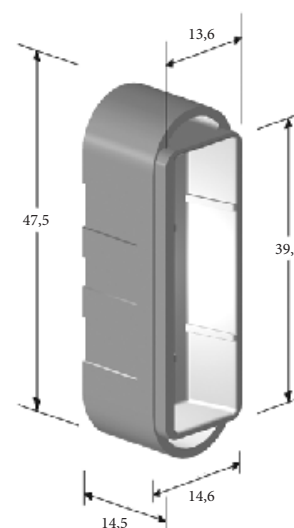
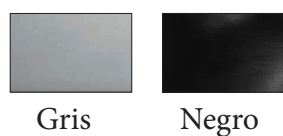

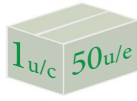

CÓDIGO	ACABADO
37495	CM
37496	LP



CM



LP

Una cerradura magnética altamente funcional con alto valor estético que combina la fluidez y el funcionamiento silencioso.

Fuerte y precisa, este bloqueo funciona por medio de imanes al cerrar, y mecánicamente al abrir, con pestillo de resorte oculto.

La cerradura magnética B-Two es la solución ideal para proteger completamente el perfil de la abrasión del pestillo.

La ausencia de partes visibles en la parte delantera hace de este sistema de cierre un elemento de mobiliario integrado en la puerta y en armonía con ella.

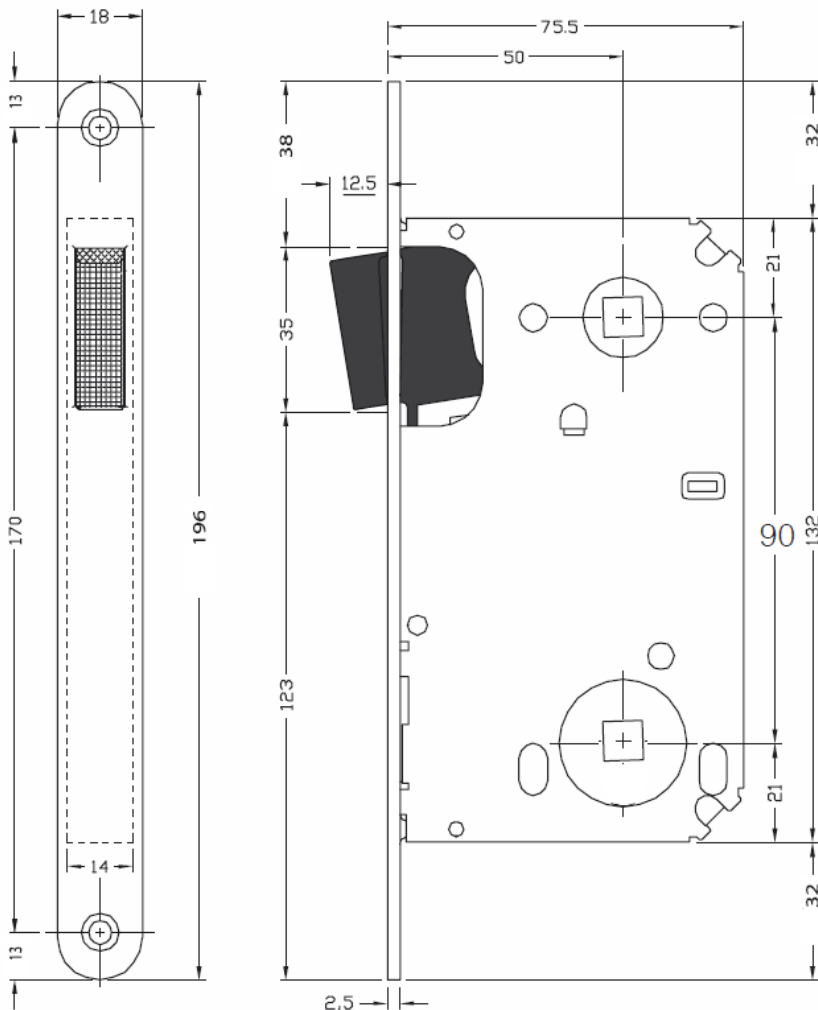



**CÓDIGO ACABADO**

37499 CM

37511 LP

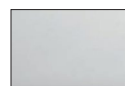

CM

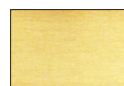

LP

Una cerradura magnética altamente funcional con alto valor estético que combina la fluidez y el funcionamiento silencioso.

Fuerte y precisa, este bloqueo funciona por medio de imanes al cerrar, y mecánicamente al abrir, con pestillo de resorte oculto.

La cerradura magnética B-Two es la solución ideal para proteger completamente el perfil de la abrasión del pestillo.

La ausencia de partes visibles en la parte delantera hace de este sistema de cierre un elemento de mobiliario integrado en la puerta y en armonía con ella.

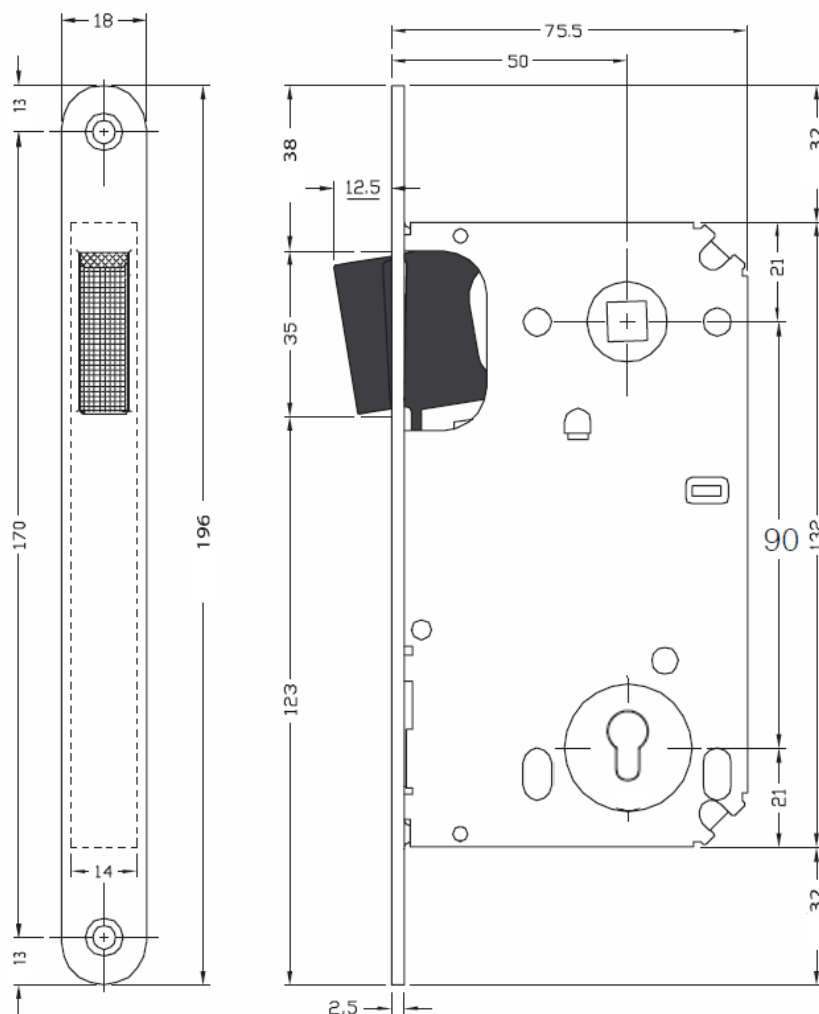

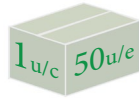

CÓDIGO	ACABADO
37497	CM
37498	LP



CM



LP

Una cerradura magnética altamente funcional con alto valor estético que combina la fluidez y el funcionamiento silencioso. Fuerte y precisa, este bloqueo funciona por medio de imanes al cerrar, y mecánicamente al abrir, con pestillo de resorte oculto. La cerradura magnética B-Two es la solución ideal para proteger completamente el perfil de la abrasión del pestillo. La ausencia de partes visibles en la parte delantera hace de este sistema de cierre un elemento de mobiliario integrado en la puerta y en armonía con ella.

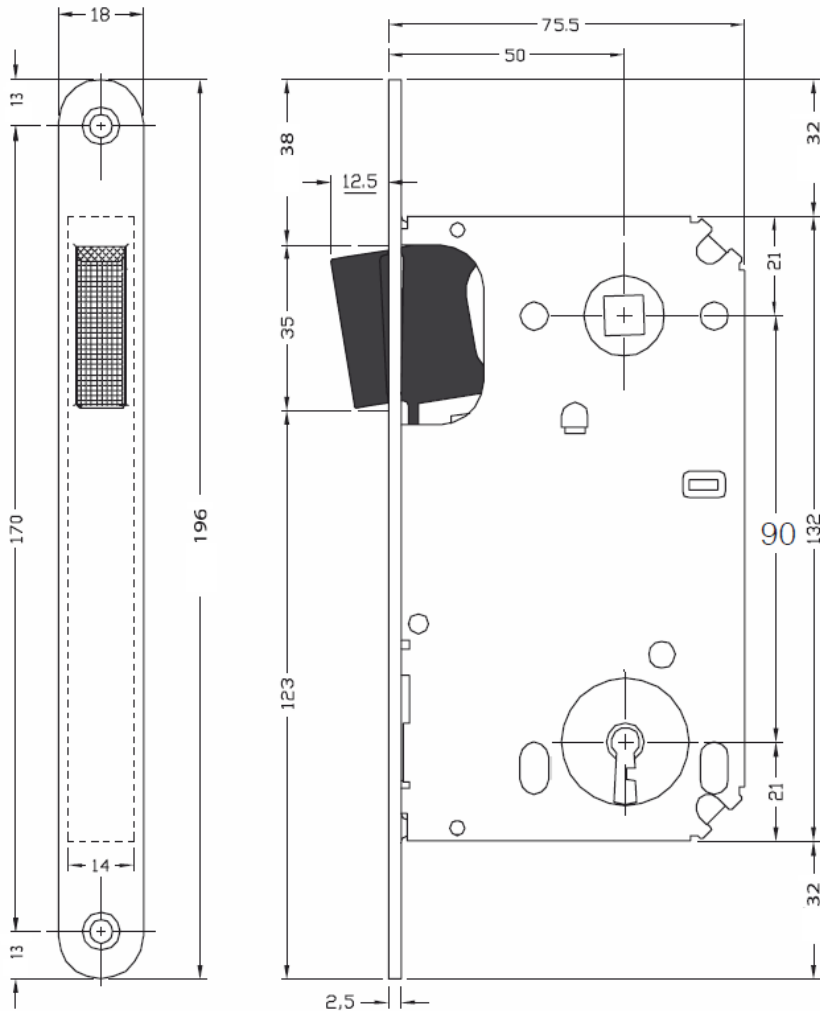

## Cerradero GR95



CÓDIGO	ACABADO
37491	CM
37492	LP

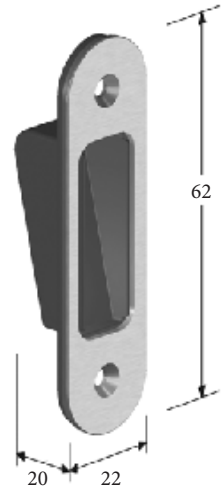
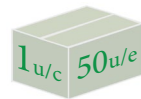
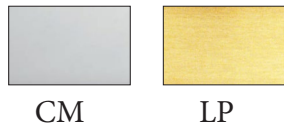

## Cerradero Reg. GR96



CÓDIGO	ACABADO
37512	CM
37513	LP

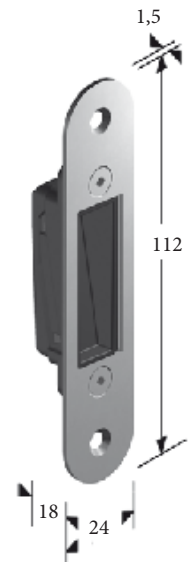
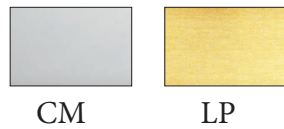

CÓDIGO ACABADO  
37493 CM



Se trata de un sistema totalmente innovador, integra un picaporte y un cerrojo magnético en un cajetín. Permite abrir y cerrar la puerta sin un picaporte visible.  
La profundidad total se ha reducido de 230 mm a 130 mm, el espesor de 26 mm a 18 mm y la placa frontal de 240x28 mm a 190x22 mm.  
B-No HA "mini" se puede aplicar fácilmente a todas las puertas y proporciona un minimalista pero muy eficaz diseño, se puede integrar con MDF o con placas de cubierta metálica.

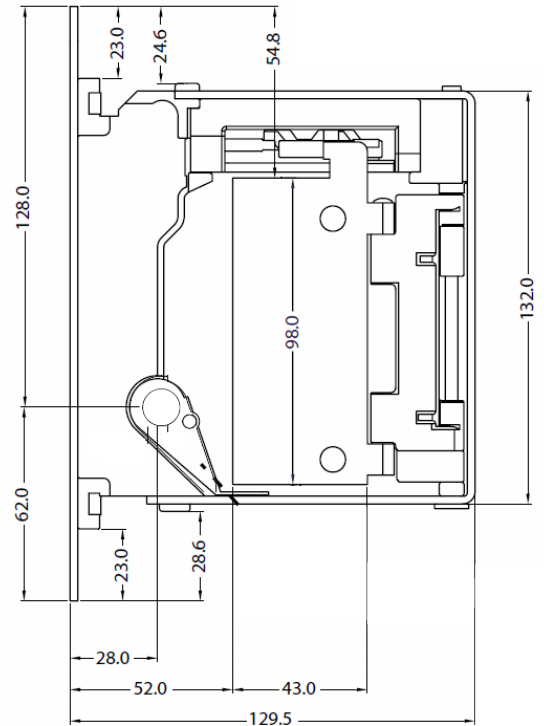
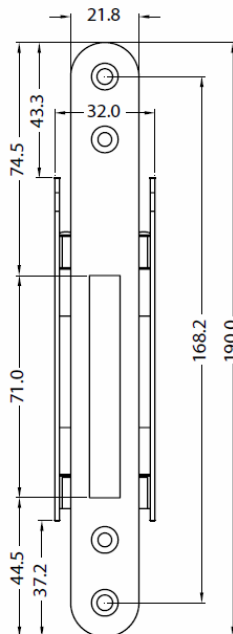
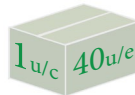



**CÓDIGO** **ACABADO**  
37494 CM



Se trata de un sistema totalmente innovador, integra un picaporte y un cerrojo magnético en un cajetín. Permite abrir y cerrar la puerta sin un picaporte visible.

La profundidad total se ha reducido de 230 mm a 130 mm, el espesor de 26 mm a 18 mm y la placa frontal de 240x28 mm a 190x22 mm. B-No HA "mini" se puede aplicar fácilmente a todas las puertas y proporciona un minimalista pero muy eficaz diseño, se puede integrar con MDF o con placas de cubierta metálica.

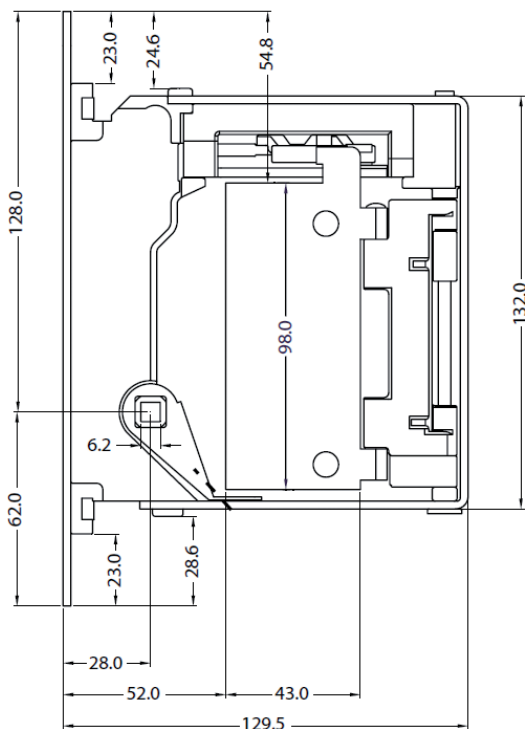
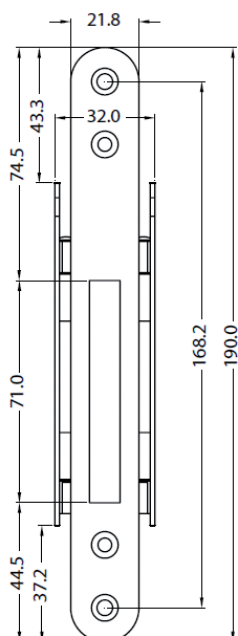
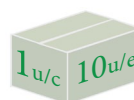

## Muletilla No-Ha Inox

La muletilla Inox No-Ha ha sido especialmente desarrollada para las cerraduras “mini”, para garantizar el look minimalista de la puerta. Los materiales utilizados se han diseñado para no perturbar el magnetismo y controlar el sistema de bloqueo.



### MONTAJE

- Montar la pieza 1
- Asegurar la pieza 2 en la 1
- Insertar en la cerradura la pieza vertical 3
- No Fije la pieza 4 en la 1
- Finalice atornillando la pieza 5 en la 4 de tal manera que la 5 esté localizada en la pieza de apertura

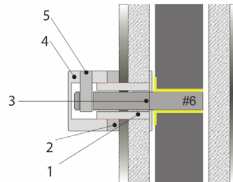

### CÓDIGO ACABADO

37494 CM

## Tirador Embutir No-Ha

El tirador de embutir No-Ha puede ser utilizado en las puertas armarios, cajones y en los sistemas de puertas que requieran que el asidero para el cierre esté ólo en un lado. Como el sistema No-Ha Mini para puertas solapadas.

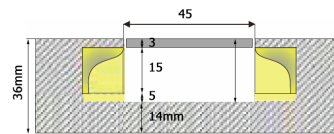
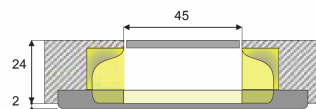
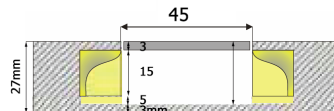
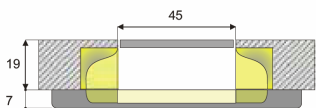
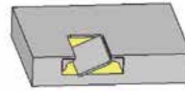

13215

13214

### Dimensiones:

- Hueco en la puerta: 87x45mm
- Tapa: 85.5x43.5 mm

### CÓDIGO MEDIDAS

13215 19-24

13214 37-48

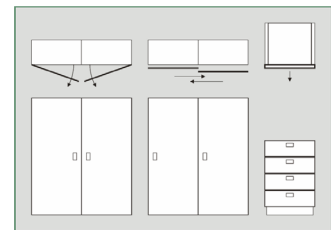

## Jgo Tirador Embutir No-Ha

El tirador de embutir No-Ha puede ser utilizado en las puertas armarios, cajones y en los sistemas de puertas que requieran que el asidero para el cierre esté ólo en un lado. Como el sistema No-Ha Mini para puertas solapadas. Puede ser utilizado en puertas desde 39mm hasta más de 48mm de espesor.



### Dimensiones:

- Hueco en la puerta: 87x45mm
- Tapa: 85.5x43.5 mm

### CÓDIGO MEDIDAS

13211 40

13212 43

13213 48

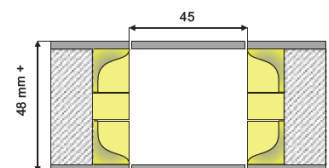
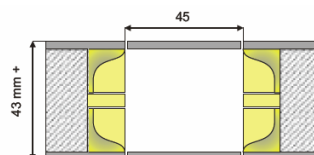
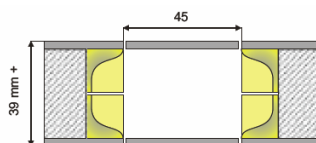

13211

13212

13213



# Jgo Bisagra Pivotante SB7

Bisagras para puertas reversibles de 40/44 mm de espesor sin solape.



- Reversible
- 2 ajustes
- Acoplamiento ideal, con Bonaiti mecánico o magnético cerraduras Bonaiti (B-slim, B-Four, B-Sweet)
- Herramientas del kit:  
2 bisagras, 2 bisagras de apoyo, 2 arandelas de nylon, 1 pin central, un perno delantero central, 1 llave para el ajuste del perno central, 12 tornillos M4x30



CÓDIGO	ACABADO
--------	---------

13201	CM
-------	----

13202	Oro
-------	-----

CÓDIGO	DESC.
--------	-------

13206	Tapa CM
-------	---------

13209	Tapa Oro
-------	----------

CÓDIGO	DESCRIPCIÓN
--------	-------------

13210	Plantilla SB7
-------	---------------

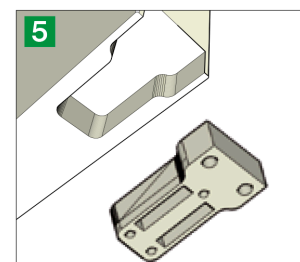
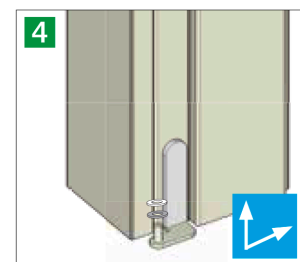
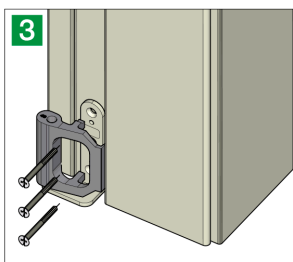
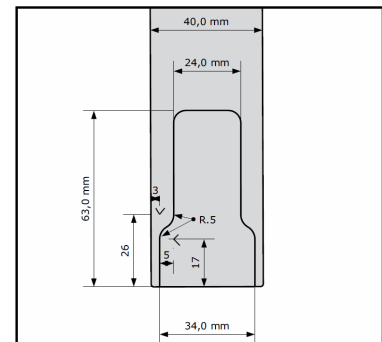
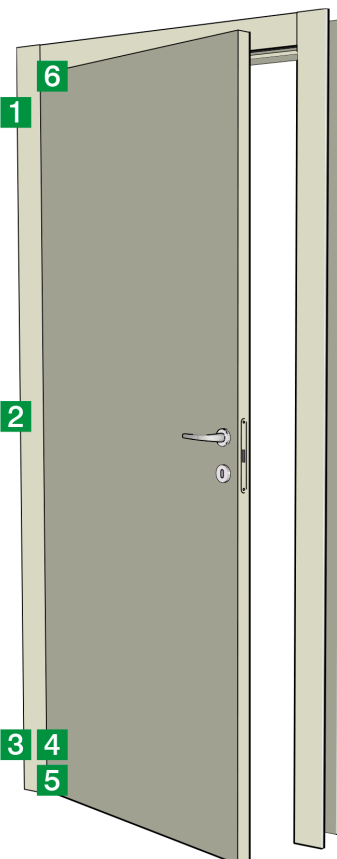
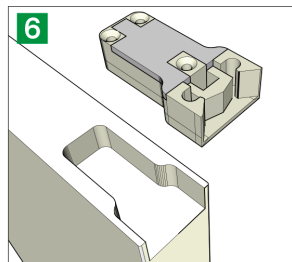
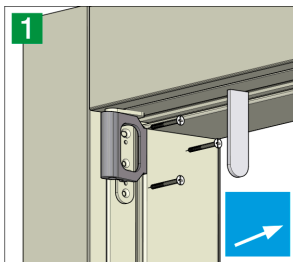

Bisagras para puertas reversibles de 40/44 mm de espesor con solape.

- Reversible
- 3 ajustes
- Acoplamiento ideal, con Bonaiti mecánico o magnético cerraduras Bonaiti (B-slim, B-Four, B-Sweet)
- Herramientas del kit:  
2 bisagras, 2 bisagras de apoyo, 2 arandelas de nylon, 1 pin central, un perno delantero central, 1 llave para el ajuste del perno central, 12 tornillos M4x30

**CÓDIGO ACABADO**

13203 CM

13205 Oro

