

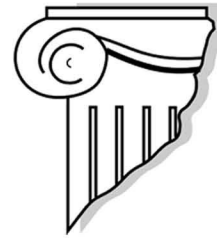

HERRAJES
DE **ANDALUCÍA**

Inox Art®



TIRADORES



Tiradores, Pomos de Mueble, Maleteros, Herrajes de Muebles...



TIRADORES INOX

TIRADOR 1212

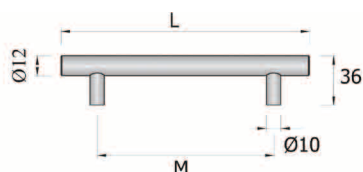

CÓDIGO	M	L
37053	96	156
10301	128	188
10303	192	252
10305	256	336
10307	320	400

CÓDIGO	M	L
10309	384	464
10311	448	528
10313	512	592
70825	640	720

Inox Art®

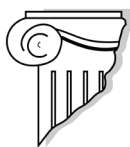

TIRADOR ATLANTE

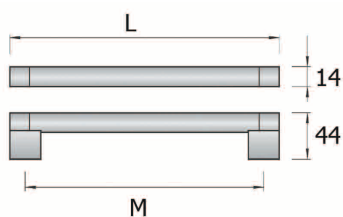

CÓDIGO	M	L
08103	192	214
08104	292	314
08105	392	414
08106	492	514
08107	592	614

TIRADOR GREEN

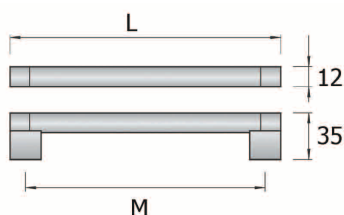

CÓDIGO	Ø	M	L
06521	Ø12	192	214
06522	Ø12	292	314
01667	Ø16	256	282
01668	Ø16	310	346

TIRADOR SATUR

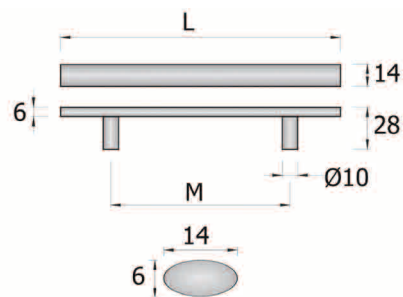

CÓDIGO	M	L
07246	128	192
07247	192	256
07248	320	384



Inox Art®

TIRADOR ARCO

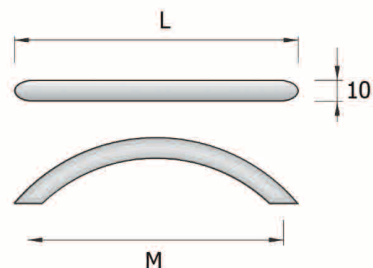
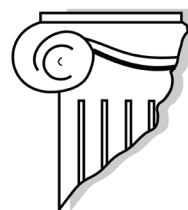
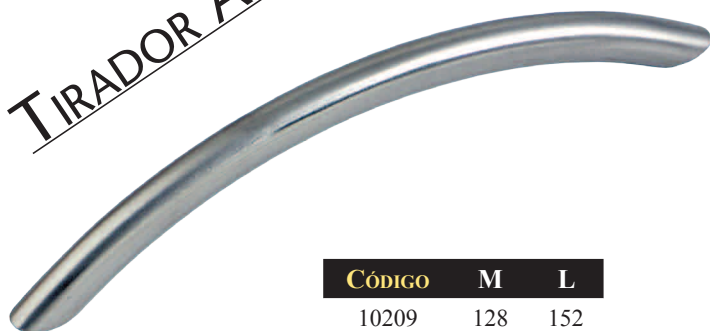

CÓDIGO	M	L
10209	128	152
10210	160	184

Inox Art®

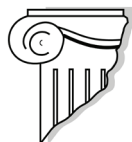

TIRADOR 7500



CÓDIGO	MEDIDA
04598	256
04599	320

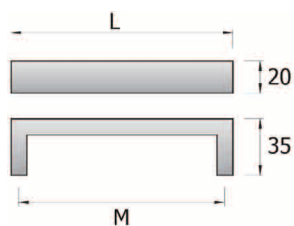

TIRADOR HIOS



Código	M	L
07252	192	202
07253	320	330

Inox Art®

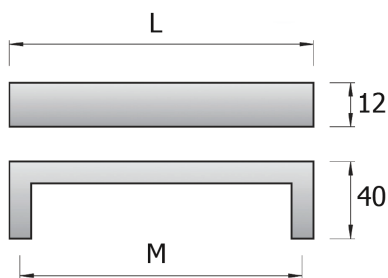
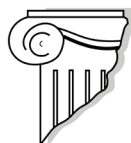

TIRADOR KUBE

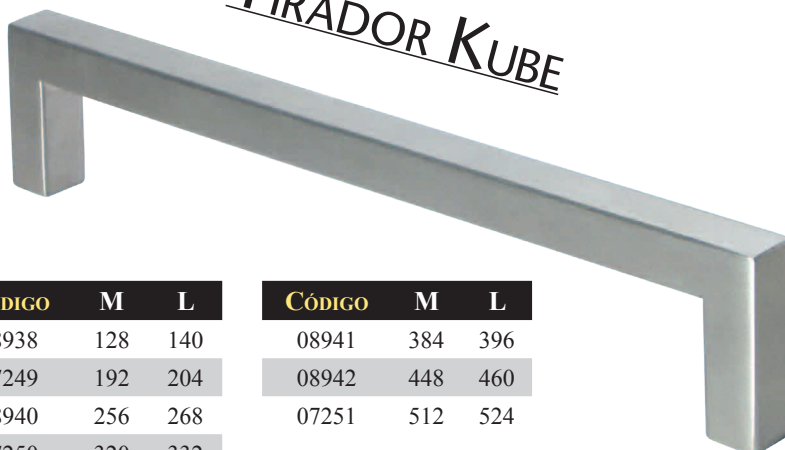

Código	M	L	Código	M	L
08938	128	140	08941	384	396
07249	192	204	08942	448	460
08940	256	268	07251	512	524
07250	320	332			

Inox Art®

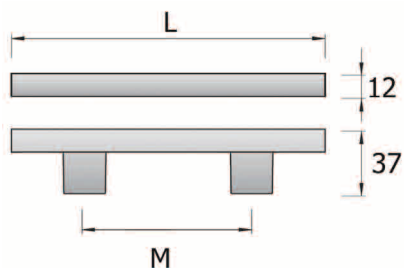

TIRADOR NIDIA



Código	M	L
07254	128	192
07255	288	352
07256	448	512
07257	736	800

POMO ROCÍN



CÓDIGO	Ø	H
08343	Ø20	33
08344	Ø25	36

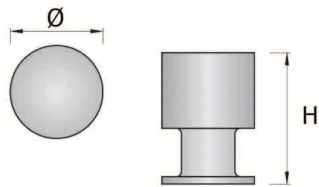

POMO CUORE



CÓDIGO	Ø	H
08345	Ø20	34
08346	Ø25	36

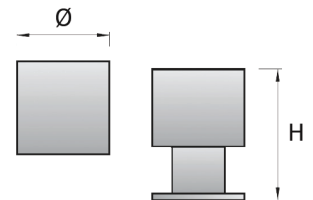

POMO RAMI

CÓDIGO	Ø	17
07470	Ø20	33
07222	Ø30	36

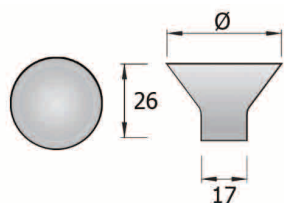

POMO CONICO

CÓDIGO	M	L	D
10279	12	20	7
10280	20	28	10

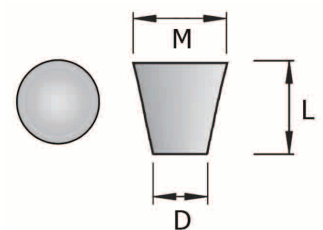

POMO MUESCA



CÓDIGO	M	L
10281	Ø15	26
10282	Ø20	28
10283	Ø25	30

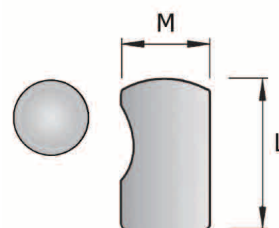

Inox Art®



POMO BOLA



CÓDIGO	M	L
10277	Ø25	29
10278	Ø30	38

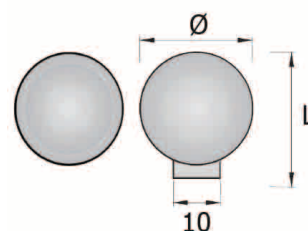

TIRADOR I008



CÓDIGO	MEDIDA
68878	Ø65

TIRADOR I007

CÓDIGO	MEDIDA
68879	120x40



TIRADOR CUADRADO



CÓDIGO	MEDIDA
07444	50x50
07445	70x70

TIRADOR RECTANGULAR



CÓDIGO	MEDIDA
07446	150x50



TIRADOR EMB. I007 OVAL C/MUELLE



CÓDIGO	MEDIDA
10579	155x45

TIRADOR EMB. C/C RECT. C/MUELLE



CÓDIGO	MEDIDA
10580	155x45

JGO OJO DE BUEY



Cristal no Incluido

CÓDIGO	MEDIDA	PUERTA
08305	26x38	H35
37024	26x38	H40

Ø26cm Interior

Ø38cm Exterior

TIRADORES ZAMAK

TIRADOR MATIZ



CÓDIGO	M	L	ACAB.
01247	128	155	ZKNS
02163	160	192	ZKNS
01248	192	222	ZKNS

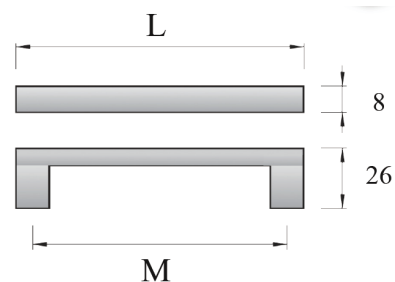

TIRADOR ARA



CÓDIGO	M	L	ACAB.
08164	128	146	ZKCM
08171	192	208	ZKCM

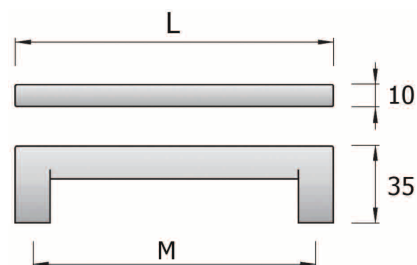

TIRADOR DELTA

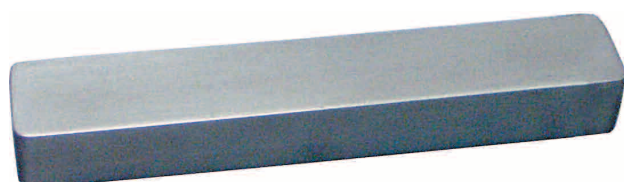

CÓDIGO	M	L	ACAB.
08420	160	198	ZKCM
08421	256	294	ZKCM

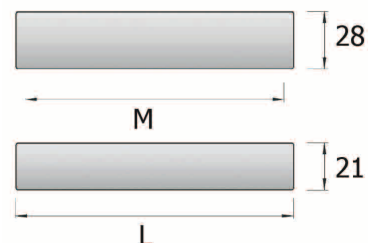

TIRADOR ALFA

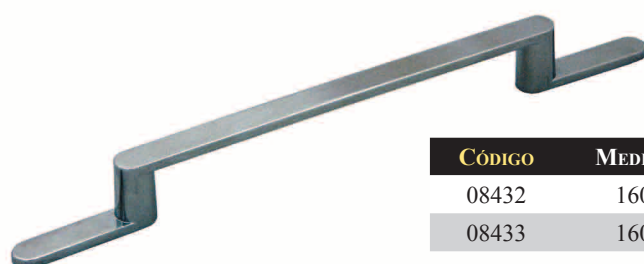

CÓDIGO	MEDIDA	ACAB.
08432	160	ZKCM
08433	160	ZKCR

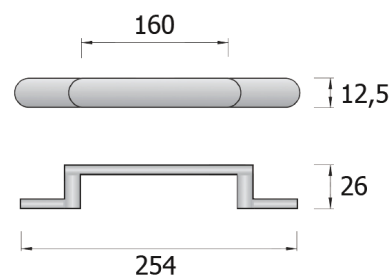

TIRADOR BETA

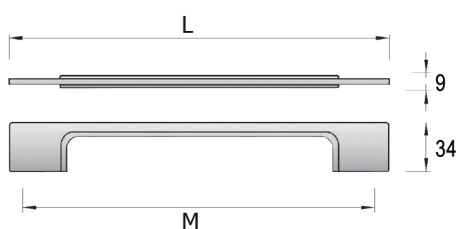

CÓDIGO	M	L	ACAB.
08424	128	238	ZKCM
08425	256	365	ZKCM
08426	128	238	ZKCR
08427	256	365	ZKCR

TIRADOR GAMMA

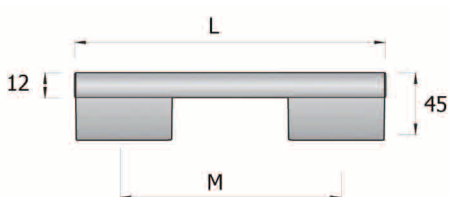

CÓDIGO	M	L	ACAB.
08428	256	306	ZKCM
08429	320	370	ZKCM
08430	384	434	ZKCR
08431	480	530	ZKCR

TIRADOR SIGMA

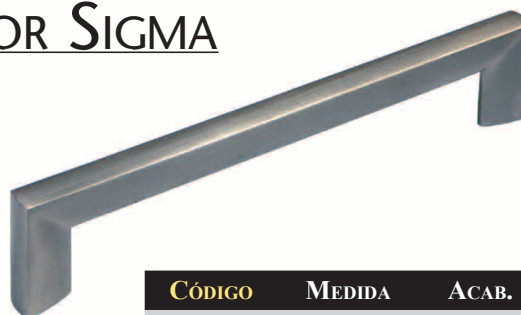
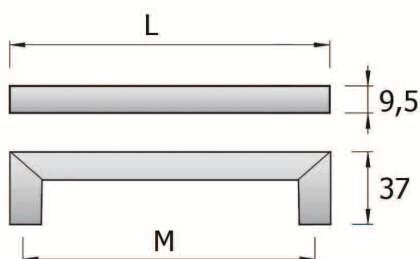

CÓDIGO	MEDIDA	ACAB.
08435	320	ZKCM

TIRADOR MICENAS

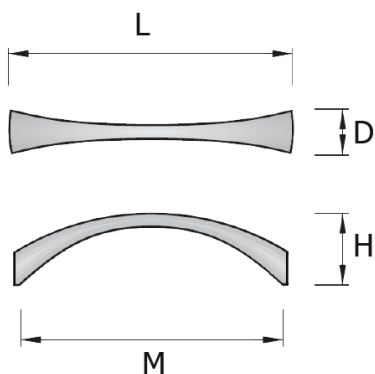

CÓDIGO	M	L	H	D	ACAB.
08339	256	277	37	14	ZKCM
08340	160	177	31	12	ZKCR

TIRADOR MIKU

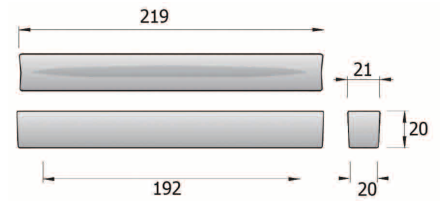
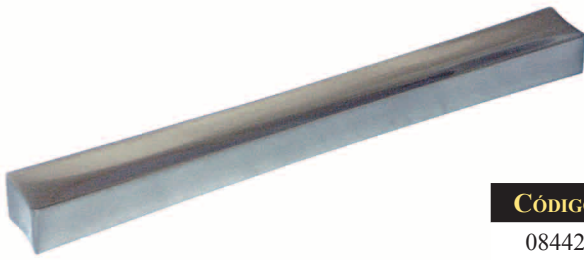

CÓDIGO	MEDIDA	ACAB.
08442	70	ZKCM
08443	70	ZKCR

TIRADOR ETNA

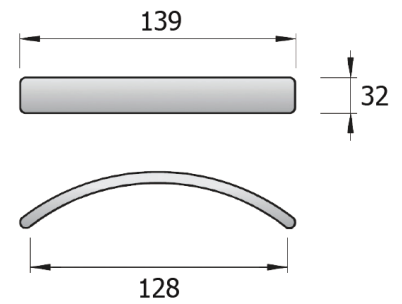

CÓDIGO	MEDIDA	ACAB.
01696	128	ZKNS

TIRADOR ARA

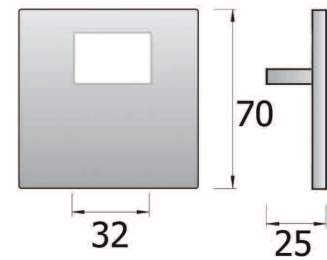

CÓDIGO	MEDIDA	ACAB.
08442	70	ZKCM
08443	70	ZKCR

TIRADOR EFESO

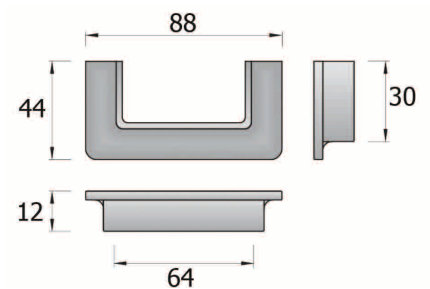

CÓDIGO	MEDIDA	ACAB.
08444	88	ZKCM

TIRADORES ALUMINIO

TIRADOR ADONIS

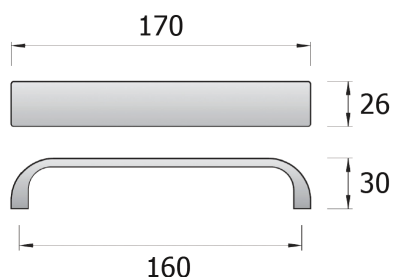

CÓDIGO	MEDIDA	ACAB.
06519	160	ALCR
06005	160	ALNS

TIRADOR AKER

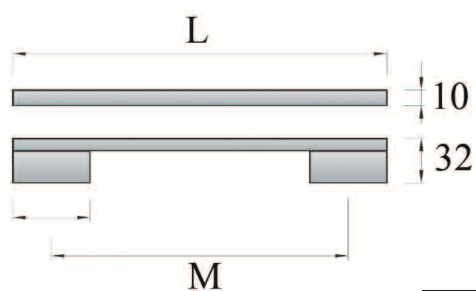

CÓDIGO	M	L	ACAB.
07447	192	242	ALCM
08163	293	342	ALCM
07448	392	442	ALCM
07449	492	542	ALCM

TIRADOR BASIC

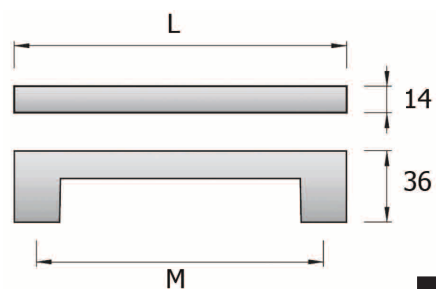

CÓDIGO	M	L	ACAB.
08172	128	162	ALCM
08173	192	232	ALCM

TIRADOR ANDROS

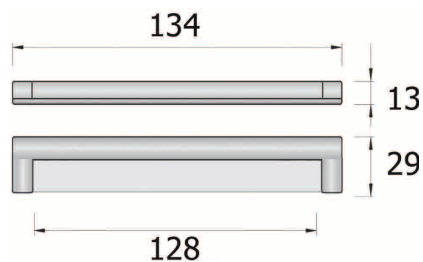
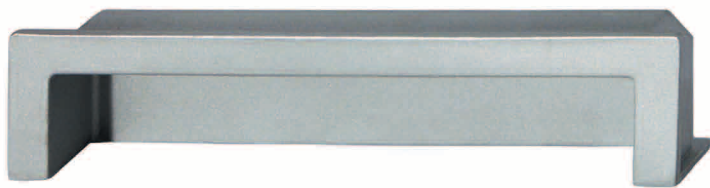

CÓDIGO	MEDIDA	ACAB.
01705	128	ALCM

TIRADOR ATENAS

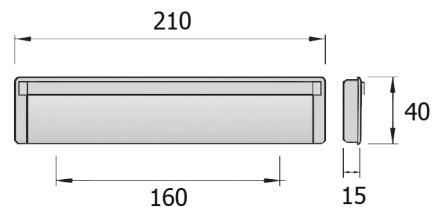
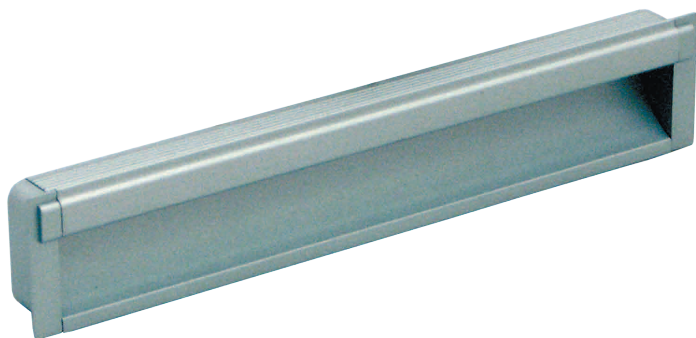

CÓDIGO	MEDIDA	ACAB.
01691	210	ALCM

TIRADOR KYRA

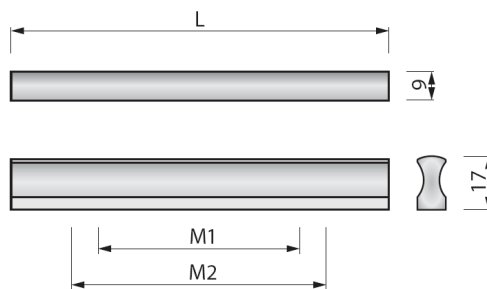
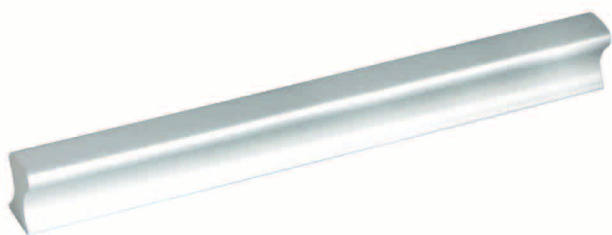

CÓDIGO	M1	M2	L	ACAB.
01677	64	-	84	ALCM
01678	128	-	148	ALCM
01679	160	192	280	ALCM
10523	64	-	84	ALCR
01679	128	-	148	ALCR
10524	160	192	280	ALCR

TIRADOR DANILO

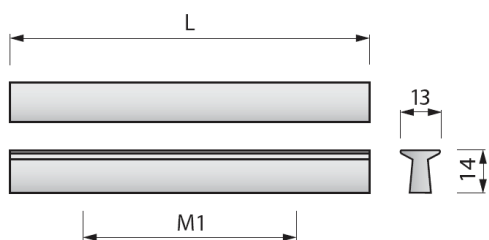

CÓDIGO	M	L	ACAB.
10518	96	150	ALCM
10520	160	xxx	ALCM
10519	96	150	ALCR
10521	160	xxx	ALCR

TIRADOR ERNEST

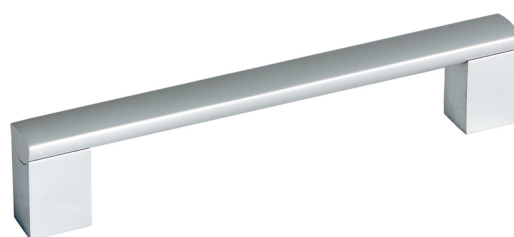
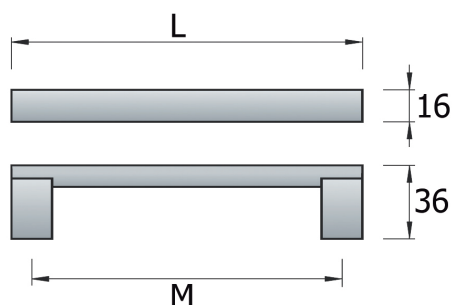

CÓDIGO	M	L	ACAB.
01690	160	172	ALCM
05603	292	300	ALCM

TIRADOR ICARO

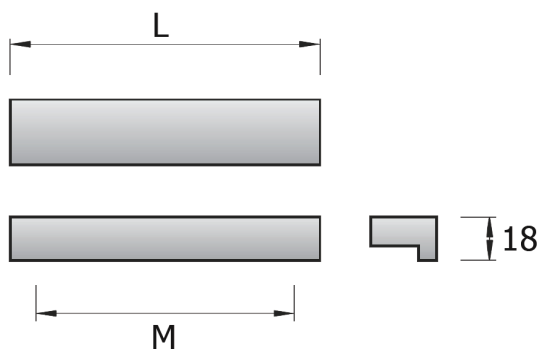

CÓDIGO	M	L	ACAB.
06016	192	226	ALCM
06012	192	226	ALNS

TIRADOR PERSA

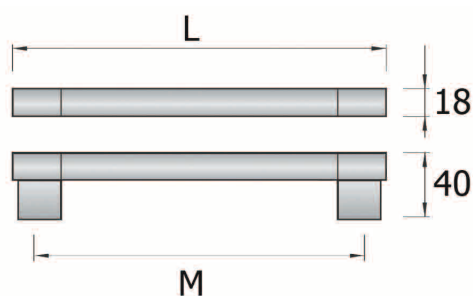

CÓDIGO	M	L	ACAB.
01671	320	368	ALCM

TIRADOR LAIA C



CÓDIGO	MEDIDA	ACAB.
07454	224	ALCM

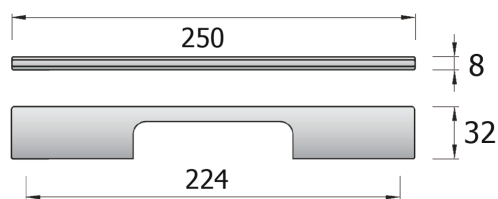

TIRADOR LAIA D



CÓDIGO	MEDIDA	ACAB.
07456	224	ALCM

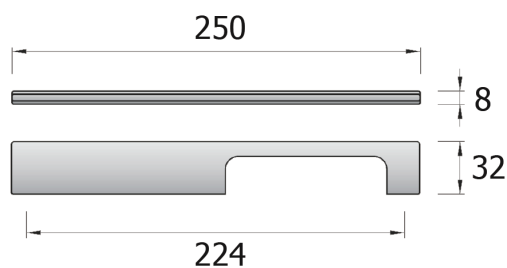

TIRADOR MASAO



CÓDIGO	M	L	ACAB.
07240	192	215	ALNS
07241	256	343	ALNS

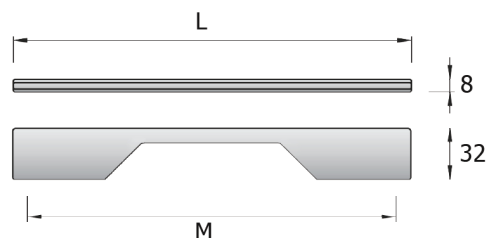

TIRADOR EPSILON



CÓDIGO	MEDIDA	ACAB.
08436	160	ALNS
08437	160	ALCM

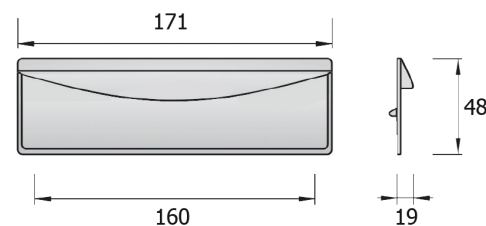

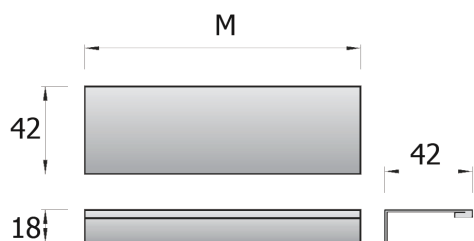

CÓDIGO	MEDIDA	ACAB.
07237	40	ALCM
07238	192	ALCM
07239	1000	ALCM



TIRADOR KIMERA

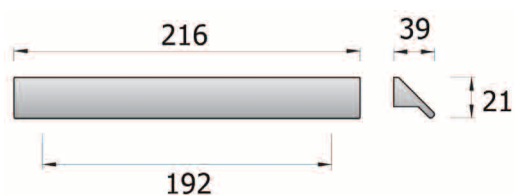

CÓDIGO	MEDIDA	ACAB.
07236	192	ALCR

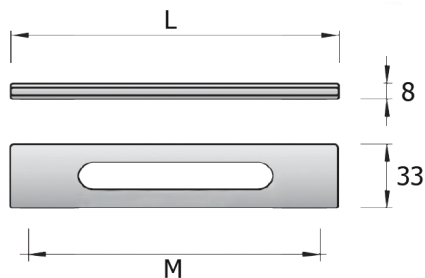
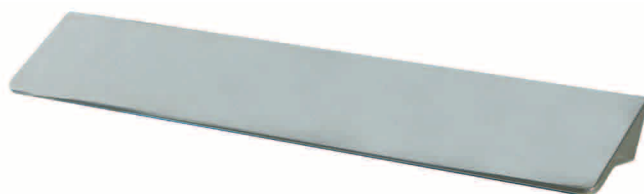

CÓDIGO	M	L	ACAB.
07230	160	216	ALNS
07231	224	316	ALNS
07232	384	516	ALNS
07233	768	816	ALNS

TIRADOR KEIZO

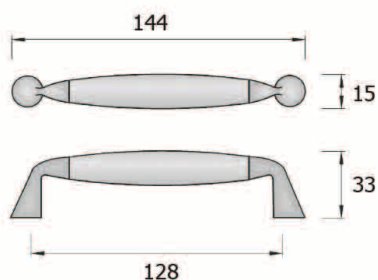
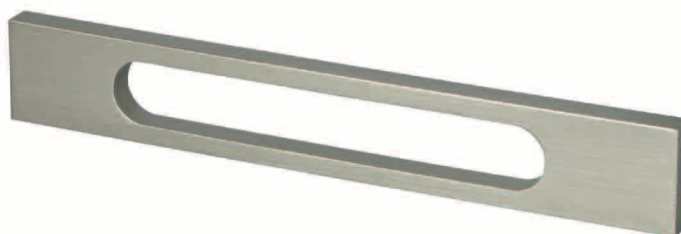

CÓDIGO	M	L	ACAB.
00904	128	144	Haya-CM

TIRADOR DELIO



ASA COMODILLA

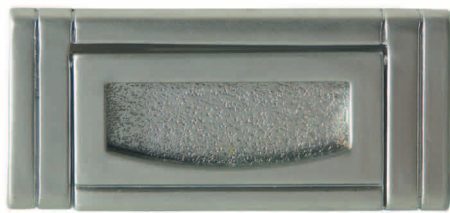

CÓDIGO	M	ACAB.
54099	80	ZKCM
54092	80	ZKORO
54091	80	ZKNS

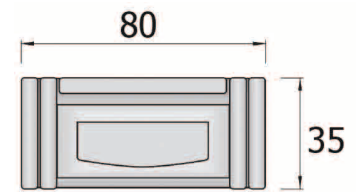

ASA ELECTRA



CÓDIGO	M	ACAB.
08342	79	ZKNS

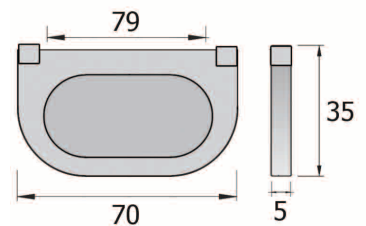

ASA CONCHA



CÓDIGO	M	ACAB.
22482	99	ZKCM
68384	99	ZKNS

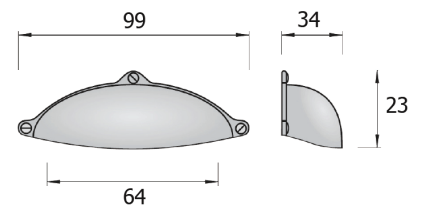

POMO CHATO PLANO



CÓDIGO	Ø	ACAB.
63010	28	ZKNS
63006	34	ZKNS
63011	28	ZKORO
63007	34	ZKORO

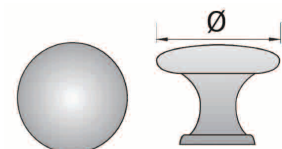

TIRADOR MUEBLE ZAMAK Y ALUMINIO

TIRADOR 5 CR

CÓDIGO	DESCRIPCIÓN
56784	125
01218	145



TIRADOR 6161 128

CÓDIGO	DESCRIPCIÓN
09866	ZKCR
09860	ZKNS
09863	ZKBR RUST.



TIRADOR 6162 96

CÓDIGO	DESCRIPCIÓN
09867	ZKCR
09861	ZKNS
09864	ZKBR RUST.



TIRADOR 6171 128

CÓDIGO	DESCRIPCIÓN
09869	ZKNS
09871	ZKBR RUST.



TIRADOR 7051-038 128 NI CEPILLADO

CÓDIGO	DESCRIPCIÓN
07773	NI CEPILLA.



TIRADOR 7131/7132-038 NI CEPILLADO

CÓDIGO	DESCRIPCIÓN
07779	128
07780	96



TIRADOR 7191-831 128

CÓDIGO	DESCRIPCIÓN
07955	BRONCE RÚST.
07956	ESTAÑO RÚST.



TIRADOR 7251-831 BRONCE RUSTICO

CÓDIGO	DESCRIPCIÓN
68884	128
69805	96



TIRADOR 7371/7372

CÓDIGO	DESCRIPCIÓN
04615	COB. RUST. 128
03167	COB. RUST. 96



TIRADOR 7491/7492

CÓDIGO	DESCRIPCIÓN
07959	BR. RUST. 128
07960	EST. RUST. 128
05408	BR. RUST. 96



TIRADOR 7531/7532 CR

CÓDIGO	DESCRIPCIÓN
09093	7531
09094	7532



TIRADOR 7561 128

CÓDIGO	DESCRIPCIÓN
07931	BRONCE RÚST.
07932	ESTAÑO RÚST.



TIRADOR 7581128



CÓDIGO	DESCRIPCIÓN
07927	BRONCE RÚST.
07928	ESTAÑO RÚST.

TIRADOR 7691-800 192 CM



CÓDIGO	DESCRIPCIÓN
07925	CM

TIRADOR 7751/7752



CÓDIGO	DESCRIPCIÓN
09095	CR 400
09096	CM 400
09097	CR 800
09098	CM 800

TIRADOR 7830-831 96 BRONCE RUSTICO



CÓDIGO	DESCRIPCIÓN
68886	BRONCE RÚST.
68887	ESTAÑO RÚST.

TIRADOR 7992 64



CÓDIGO	DESCRIPCIÓN
66678	NI CEPILLADO
66682	ORO

TIRADOR COUNTRY

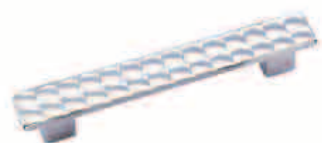

CÓDIGO	DESCRIPCIÓN
09398	CR 128
09399	BR. RUST 96

TIRADOR H-0109 ORO VIEJO



CÓDIGO	DESCRIPCIÓN
12515	96MM

TIRADOR H-0040 ORO VIEJO



CÓDIGO	DESCRIPCIÓN
12511	128MM

TIRADOR H-0034 ORO VIEJO



CÓDIGO	DESCRIPCIÓN
12510	128MM

TIRADOR H-0042 ORO VIEJO



CÓDIGO	DESCRIPCIÓN
12507	96MM

TIRADOR MUEBLE C/CUERO

TIRADOR CRETA F215 CUERO ZKCM



CÓDIGO	DESCRIPCIÓN
08449	128

POMO CRETA REDONDO CUERO



CÓDIGO	DESCRIPCIÓN
08334	ZKCM

POMO CRETA LAZO CUERO



CÓDIGO	DESCRIPCIÓN
08335	ZKCM

POMO MUEBLE LATÓN

POMO 348/347 BRONCE

CÓDIGO	DESCRIPCIÓN
10174	26
10172	30



POMO 373/374

CÓDIGO	DESCRIPCIÓN
66019	CR 25



POMO 377-15 CM

CÓDIGO	DESCRIPCIÓN
66026	15



POMO CHATO CS

CÓDIGO	DESCRIPCIÓN
03328	Ø25 CS



POMO CHATO LP

CÓDIGO	DESCRIPCIÓN
51955	Ø25
51956	Ø30



POMO LISO LT

CÓDIGO	DESCRIPCIÓN
55678	20



POMO OVAL AB-006/35

CÓDIGO	DESCRIPCIÓN
65729	AF
08217	FAN



POMO PEÓN LATÓN 8Ø NS

CÓDIGO	DESCRIPCIÓN
08091	NS



POMO REDONDO 1361-30 LP

CÓDIGO	DESCRIPCIÓN
52300	211GPBT



POMO REDONDO 36X

CÓDIGO	DESCRIPCIÓN
52299	LP Ø25
66091	CM Ø20
66054	CR Ø20
51957	LP Ø20
66056	CM Ø15



POMO MUEBLE ZAMAK Y ALUMINIO

POMO 26 CS



CÓDIGO	DESCRIPCIÓN
09953	28
09952	33



POMO 6160 23

CÓDIGO	DESCRIPCIÓN
09865	ZKCR
09859	ZKNS
09862	ZKBRONCE RUST.

POMO 6170 45



CÓDIGO	DESCRIPCIÓN
09868	ZKCR
09870	ZKBRus



POMO 7694-800 16 CM

CÓDIGO	DESCRIPCIÓN
07926	CM

POMO 8080-800 CM



CÓDIGO	DESCRIPCIÓN
05407	CM



POMO 8102/8103 - 800 CM

CÓDIGO	DESCRIPCIÓN
05410	50
05411	32

POMO 8130 15



CÓDIGO	DESCRIPCIÓN
05406	NS
05405	CM

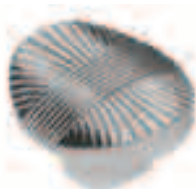

POMO 8491 35 RUSTICO

CÓDIGO	DESCRIPCIÓN
05409	BRONCE
07961	ESTAÑO

POMO 8562 28x18 RUSTICO



CÓDIGO	DESCRIPCIÓN
07953	BRONCE
07954	ESTAÑO



POMO 8581 34Ø RUSTICO

CÓDIGO	DESCRIPCIÓN
07929	BRONCE
07930	ESTAÑO

POMO 8651 35Ø BRONCE RUSTICO



CÓDIGO	DESCRIPCIÓN
68888	BRONCE



POMO 8652 30Ø RUSTICO

CÓDIGO	DESCRIPCIÓN
68890	BRONCE
68891	ESTAÑO

POMO 8701/8702 BRONCE RUSTICO

CÓDIGO	DESCRIPCIÓN
68894	Ø35
68896	Ø30



POMO 8770-038 NI CEPILLADO

CÓDIGO	DESCRIPCIÓN
07728	40x18



POMO CHATO PLANO ZKNS

CÓDIGO	DESCRIPCIÓN
63010	Ø28
63006	Ø34



POMO CHATO PLANO ZKORO

CÓDIGO	DESCRIPCIÓN
63011	Ø28
63007	Ø34



POMO F316 ADARA AF

CÓDIGO	DESCRIPCIÓN
08457	AF



POMO F3125L NICIA AF

CÓDIGO	DESCRIPCIÓN
08459	AF



POMO REDONDO 325/332 ZK

CÓDIGO	DESCRIPCIÓN
63215	ZKORO 30



POMO COUNTRY 8142 32 BR. RÚSTICO

CÓDIGO	DESCRIPCIÓN
09401	37x37



POMO H-0024 PL OX

CÓDIGO	DESCRIPCIÓN
12500	31,9MM



POMO H-0096 ORO VIEJO

CÓDIGO	DESCRIPCIÓN
12502	23MM



POMO H-0049 ORO VIEJO

CÓDIGO	DESCRIPCIÓN
12504	30x35MM



POMO H-0050 ORO VIEJO

CÓDIGO	DESCRIPCIÓN
12506	59,5x34,5



POMO MUEBLE RESINA

POMO BOLA 28Ø C/T B&P

CÓDIGO	DESCRIPCIÓN
16231	BL
16245	NE



POMO BOLA 34Ø C/T B&P

CÓDIGO	DESCRIPCIÓN
16230	BL
16244	NE



POMO MUEBLE MADERA



POMO 9090 21x21 CM

CÓDIGO	DESCRIPCIÓN
04602	FRESNO
04605	HAYA



POMO BOLA HAYA 204- BARNIZ B&P

CÓDIGO	DESCRIPCIÓN
53881	Ø30
53825	Ø35



POMO BOLA HAYA 204- NOGAL B&P

CÓDIGO	DESCRIPCIÓN
53824	Ø30
53807	Ø35



POMO CHATO HAYA 200 B&P

CÓDIGO	DESCRIPCIÓN
60829	CRUDO 30
54151	NOGAL 30
65843	BARNIZ 35
53885	NOGAL 40



POMO CHATO PINO 200 B&P

CÓDIGO	DESCRIPCIÓN
59360	BARNIZ 30
20272	CRUDO 30
53887	BARNIZ 35
55080	CRUDO 35
59359	BARNIZ 40
55931	CRUDO 40



POMO CHATO ROBLE 200 B&P

CÓDIGO	DESCRIPCIÓN
53883	BARNIZ 35
56210	CRUDO 35
55932	CRUDO 40

TIRADOR MUEBLE MADERA

TIRADOR 9383-815 HAYA BARNIZ/CM



CÓDIGO	DESCRIPCIÓN
04603	128

TIRADOR DELIO HAYA/CM



CÓDIGO	DESCRIPCIÓN
00904	128

POMO MUEBLE POLI/DUR BASE ZAMAK



POMO BOLA 5201-002 BL

CÓDIGO	DESCRIPCIÓN
07802	Ø34

POMO MUEBLE INFANTIL

POMO FLOR 5922-028 36 ROSA

CÓDIGO	DESCRIPCIÓN
01964	ROSA



POMO PATO 5942-019 36 AM

CÓDIGO	DESCRIPCIÓN
01956	AM



POMO RANA 5951-004 36 VE

CÓDIGO	DESCRIPCIÓN
01951	VE



POMO RED. CORAZÓN 5921 36 ROSA

CÓDIGO	DESCRIPCIÓN
01963	ROSA



POMO CORAZÓN 5605 AL/RESINA

CÓDIGO	DESCRIPCIÓN
09820	45x45



POMO ESTRELLA CÍRCULO 5604

CÓDIGO	DESCRIPCIÓN
09819	45x45



POMO ESTRELLA PEZ 5601 AL/RESINA

CÓDIGO	DESCRIPCIÓN
09715	45x45



POMO PEZ 5603 AL/RESINA

CÓDIGO	DESCRIPCIÓN
09717	45x45



POMO MUEBLE BAÑO

POMO BAÑO Z-01 EFECTO MATE

CÓDIGO	DESCRIPCIÓN
12012	EFECTO MATE



POMO BAÑO Z-19 EFECTO MATE

CÓDIGO	DESCRIPCIÓN
12013	EFECTO MATE



POMO MUEBLE PORCELANA / CERÁMICA



POMO 9771-836 ESTAÑO RÚSTICO

CÓDIGO	DESCRIPCIÓN
07962	Ø34



POMO 9831-831 CRAQUELE/BR RÚSTICO

CÓDIGO	DESCRIPCIÓN
04612	Ø34



POMO OVAL ARCILLA-BRONCE

CÓDIGO	DESCRIPCIÓN
67800	AF



POMO P02003206 OVAL BL DECO

CÓDIGO	DESCRIPCIÓN
67784	BL



POMO P02025702 OVAL GRES DECO-BR

CÓDIGO	DESCRIPCIÓN
67807	GRES



POMO SA303 B BL DEC. CHATO

CÓDIGO	DESCRIPCIÓN
67777	BL DEC



POMO T04 BL DECO-O.L.

CÓDIGO	DESCRIPCIÓN
67770	NARANJA
67771	FRESAS
67772	CEREZA



POMO T304/T305 BL DECO-O.L.

CÓDIGO	DESCRIPCIÓN
67773	OSITO
67774	PEZ
67775	CÁNCER



POMO ARCILLA-BRONCE CHATO

CÓDIGO	DESCRIPCIÓN
67801	T-C-CER
67802	TP-C-CER



POMO T-C-C ARCILLA-BRONCE CHATO

CÓDIGO	DESCRIPCIÓN
67776	T-C-Ce



POMO ZR 15 CR BL DECO-CR

CÓDIGO	DESCRIPCIÓN
67778	CALABAZA



POMO ZR-C-CER BR ARCILLA-BR

CÓDIGO	DESCRIPCIÓN
67803	CALABAZA



BERLOQUI PL DECO

CÓDIGO	DESCRIPCIÓN
67783	BN/110
67788	BN/166
67798	CH/119BR



POMO H-0026 ORO VIEJO-P1

CÓDIGO	DESCRIPCIÓN
12501	18,7

HERRAJE MUEBLE ESTILO CLÁSICO

ANILLA C/PL OVAL PATINA

CÓDIGO	DESCRIPCIÓN
03722	1391A00



ANILLA F3219S LARPA

CÓDIGO	DESCRIPCIÓN
08465	AB



ANILLA M1022D00 OPR BRILLO ARO

CÓDIGO	DESCRIPCIÓN
66388	22x28



ANILLA M1023B00 PATINA COLUMPIO

CÓDIGO	DESCRIPCIÓN
66391	23x26



ANILLA M1026B00 NR NE RUSTICO

CÓDIGO	DESCRIPCIÓN
02243	40x42



ANILLA NV VIEJO 53x50 ARO

CÓDIGO	DESCRIPCIÓN
66404	M1157A00



ANILLA PLACA F3212S

CÓDIGO	DESCRIPCIÓN
08463	MIRTO CIM



ANILLA PLACA LARGA F3212L

CÓDIGO	DESCRIPCIÓN
08460	MIRTO CIM



ANILLA PLACA M1005 OPR BRILLO 56

CÓDIGO	DESCRIPCIÓN
66382	56
66383	40



ASA 110-A1 102 CS

CÓDIGO	DESCRIPCIÓN
60599	CS



ASA 1358A SWAROVSKI 1

CÓDIGO	DESCRIPCIÓN
08315	FAN
08316	Patina



ASA C/PL 103-B 110 ORO VIEJO

CÓDIGO	DESCRIPCIÓN
60585	ORO VIEJO



ASA C/PL 110-B 93 CS

CÓDIGO	DESCRIPCIÓN
60598	CS



ASA C/PL C/B M1160000 96x43

CÓDIGO	DESCRIPCIÓN
66409	PATINA
66408	LP



ASA C/PL FS3212-64 MIRTO CIM



CÓDIGO	DESCRIPCIÓN
08464	CIM

ASA C/PL C/PL M1046 OPR BRILLO CALA



CÓDIGO	DESCRIPCIÓN
66395	95
66396	78

ASA FIJA 96 1329000 PATINA



CÓDIGO	DESCRIPCIÓN
03713	PATINA

ASA FIJA C/B M1203000 NV VIEJO



CÓDIGO	DESCRIPCIÓN
66416	117

ASA FIJA M1164B00 OLU LP



CÓDIGO	DESCRIPCIÓN
02227	63x36

ASA FIJA M1201B00 NV VIEJO CUAD.



CÓDIGO	DESCRIPCIÓN
66414	96

ASA FIJA RAYAS 96 1332000 PATINA



CÓDIGO	DESCRIPCIÓN
03716	PATINA

ASA FIJA VERT C/B M1173000 OLU LP



CÓDIGO	DESCRIPCIÓN
02230	25x82

ASA M1042B00 NV VIEJO MARGARITA



CÓDIGO	DESCRIPCIÓN
66393	132
66394	100

ASA M1093A00 OPR BRILLO CUADRA-BOLA



CÓDIGO	DESCRIPCIÓN
66397	114

ASA C/PL M1294 NV VIEJO



CÓDIGO	DESCRIPCIÓN
01386	35x15
01387	25x75

ANILLA PLACA H-0065 ORO VIEJO



CÓDIGO	DESCRIPCIÓN
12509	53MM

ASA M1118 OPR BRILLO CURVA-NUDO



CÓDIGO	DESCRIPCIÓN
66401	119
66402	116

ASA M1174 CURVA



CÓDIGO	DESCRIPCIÓN
66410	BRILLO 120
66412	BRILLO 84
66413	PATINA 84

ASA M133300 PATINA



CÓDIGO	DESCRIPCIÓN
08324	PATINA

BASE POMO 103-A 100 ORO VIEJO



CÓDIGO	DESCRIPCIÓN
60588	ORO VIEJO

BERLOQUI 103-C 82 ORO VIEJO



CÓDIGO	DESCRIPCIÓN
60584	ORO VIEJO

BERLOQUI 110-D 75 CS



CÓDIGO	DESCRIPCIÓN
60597	CS

BOCALLAVE 353200 PATINA



CÓDIGO	DESCRIPCIÓN
03724	PATINA

BOCALLAVE HORIZ. B3415 ARO 96x33



CÓDIGO	DESCRIPCIÓN
10661	LP
10671	PATINA

BOCALLAVE MUEBLE HORIZ. 100 LP



CÓDIGO	DESCRIPCIÓN
60576	LP

BOCALLAVE MUEBLE HORIZ. 103



CÓDIGO	DESCRIPCIÓN
60586	ORO VIEJO

BOCALLAVE MUEBLE HORIZ. 110 CS



CÓDIGO	DESCRIPCIÓN
60600	CS

BOCALLAVE MUEBLE VERTICAL 100 LP



CÓDIGO	DESCRIPCIÓN
60577	LP

BOCALLAVE MUEBLE VERTICAL 103



CÓDIGO	DESCRIPCIÓN
60587	ORO VIEJO

BOCALLAVE MUEBLE VERTICAL 110 CS



CÓDIGO	DESCRIPCIÓN
60601	CS



BOCALLAVE VERT. B3415AVO OLU 33x96

CÓDIGO	DESCRIPCIÓN
10662	LP



BOCALLAVE VERT. C/BORDE 15x12 LP

CÓDIGO	DESCRIPCIÓN
01878	15x12



BOCALLAVE EMBUTIR 7172 LP

CÓDIGO	DESCRIPCIÓN
00589	LP



BOCALLAVE SOB BR EM5631

CÓDIGO	DESCRIPCIÓN
07602	31x19



BOCALLAVE SOB BR EM5641

CÓDIGO	DESCRIPCIÓN
07603	47x39



BOCALLAVE 0408

CÓDIGO	DESCRIPCIÓN
09902	CR
00159	ORO



EMBELLECEDOR V6742000210 AU PATINA

CÓDIGO	DESCRIPCIÓN
01378	11x3



EMBELLECEDOR V6728A00210 AU PATINA

CÓDIGO	DESCRIPCIÓN
01375	7x2'5



BOCALLAVE VERT. B3414000 NV 3x6

CÓDIGO	DESCRIPCIÓN
66419	VIEJO



BOCALLAVE BC PORCELANA

CÓDIGO	DESCRIPCIÓN
67817	PORC BLANCA
67818	PORC. MARFIL



PÉNDULO C/B 103-B 125 ORO VIEJO

CÓDIGO	DESCRIPCIÓN
60582	125



PÉNDULO C/B 100 LP

CÓDIGO	DESCRIPCIÓN
60568	155
60572	100

PÉNDULO C/B 110 CS

CÓDIGO	DESCRIPCIÓN
60591	138
60593	115
60595	95



PÉNDULO S/B 100 LP

CÓDIGO	DESCRIPCIÓN
60569	155
60571	125
60573	100



PÉNDULO S/B 103 ORO VIEJO

CÓDIGO	DESCRIPCIÓN
60581	170
60583	125



PÉNDULO S/B 110 CS

CÓDIGO	DESCRIPCIÓN
60592	138
60594	115
60596	95



POMO 100/30Ø LP

CÓDIGO	DESCRIPCIÓN
60579	LP



POMO 103 ORO VIEJO

CÓDIGO	DESCRIPCIÓN
60589	25Ø
60590	30Ø



POMO 110 CS

CÓDIGO	DESCRIPCIÓN
60602	25Ø
60603	30Ø



POMO CI-008 NE C/BASE Y RESALTE

CÓDIGO	DESCRIPCIÓN
68808	38



POMO 23300 PATINA

CÓDIGO	DESCRIPCIÓN
03718	35Ø
03717	40Ø



POMO 30 P230003033 FAN

CÓDIGO	DESCRIPCIÓN
01545	FAN



POMO 30 P2306030210 PATINA

CÓDIGO	DESCRIPCIÓN
01549	PATINA



POMO 30 P230903033 FAN

CÓDIGO	DESCRIPCIÓN
01547	FAN





POMO T 1334000

CÓDIGO	DESCRIPCIÓN
03728	FAN
03729	PATINA



POMO P2335038 NV VIEJO OVAL

CÓDIGO	DESCRIPCIÓN
66417	NV

TIRADOR H-00104 CR



CÓDIGO	DESCRIPCIÓN
12514	128MM

TIRADOR H-0097 CR



CÓDIGO	DESCRIPCIÓN
12513	50x50MM

TIRADOR H-0101 34x67



CÓDIGO	DESCRIPCIÓN
12541	CR
12505	NS

TIRADOR H-0100 51,5MM



CÓDIGO	DESCRIPCIÓN
12540	CR
12503	NS



POMO 23520C SWAROVSKI 1

CÓDIGO	DESCRIPCIÓN
08317	FAN
08318	PATINA



POMO 23450C 27'5 SWAROVSKI 2

CÓDIGO	DESCRIPCIÓN
08311	FAN
08312	PATINA
08322	CR

POMO 23440C 39'5 SWAROVSKI 6



CÓDIGO	DESCRIPCIÓN
08313	FAN
08314	PATINA
08321	CR

TIRADOR 1348B 99 SWAROVSKI 8



CÓDIGO	DESCRIPCIÓN
08320	CR
08309	FAN
08310	PATINA

TIRADOR 1348A 146 SWAROVSKI 12



CÓDIGO	DESCRIPCIÓN
08319	CR
08307	FAN
08308	PATINA

HERRAJE MUEBLE ZAMAK ESTILO CLÁSICO

ANILLA PLACA 2166 CS

CÓDIGO	DESCRIPCIÓN
10676	2166.032.001
10675	2166.042.001



ASA ARO OVAL 54 CS

CÓDIGO	DESCRIPCIÓN
09983	CS



ASA C/PL 200-A ORO VIEJO

CÓDIGO	DESCRIPCIÓN
63912	130
63913	105



ASA C/PL 2172.032.001 CS

CÓDIGO	DESCRIPCIÓN
58358	CS



ASA C/PL 2218.064.001 CS

CÓDIGO	DESCRIPCIÓN
10678	CS



ASA FIJA 202-B 145 ORO VIEJO

CÓDIGO	DESCRIPCIÓN
65832	DCHA
65833	IZDA



ASA 27 CS

CÓDIGO	DESCRIPCIÓN
65677	GRANDE
09959	PEQUEÑA



ASA PEQUEÑA 58 CS

CÓDIGO	DESCRIPCIÓN
53546	CD



BOCALLAVE 6110.034.002 CUERO

CÓDIGO	DESCRIPCIÓN
10666	PATINA



BOCALLAVE MUEBLE HORIZ. 200

CÓDIGO	DESCRIPCIÓN
64539	ORO VIEJO



BOCALLAVE MUEBLE VERTICAL 200

CÓDIGO	DESCRIPCIÓN
64540	ORO VIEJO



PÉNDULO C/B 200 ORO VIEJO

CÓDIGO	DESCRIPCIÓN
63909	170
63911	135



PÉNDULO C/B 3175.135.B.001 CS

CÓDIGO	DESCRIPCIÓN
10669	135



PÉNDULO C/B 3219.110.B.001 CS

CÓDIGO	DESCRIPCIÓN
10654	110





PÉNDULO C/B 3221 CS

CÓDIGO	DESCRIPCIÓN
10655	150
10653	180



PÉNDULO S/B 200 ORO VIEJO

CÓDIGO	DESCRIPCIÓN
63908	170
63910	135



PÉNDULO S/B 3175.135.A.001 CS

CÓDIGO	DESCRIPCIÓN
10660	CS



PÉNDULO S/B 3221 CS

CÓDIGO	DESCRIPCIÓN
10651	150
10652	180



PÉNDULO S/B 27 CS

CÓDIGO	DESCRIPCIÓN
09966	GDE
09964	MED
09958	PEQ



TIRADOR 7335 CS

CÓDIGO	DESCRIPCIÓN
59859	129
59860	185



PÉNDULO C/B 27 CS

CÓDIGO	DESCRIPCIÓN
09965	GDE
09963	MED
09971	PEQ



PÉNDULO S/B 3174.106.A.001 CS

CÓDIGO	DESCRIPCIÓN
10673	CS



PÉNDULO S/B 3219.110.A.001 CS

CÓDIGO	DESCRIPCIÓN
10650	CS



PÉNDULO S/B 3248.132.A.001 CS

CÓDIGO	DESCRIPCIÓN
10677	CS



PÉNDULO S/B H-0066 ORO VIEJO

CÓDIGO	DESCRIPCIÓN
12542	130MM



POMO 200 ORO VIEJO

CÓDIGO	DESCRIPCIÓN
63914	28Ø
63915	33Ø

HERRAJE MUEBLE ESTILO ESPAÑOL

ANILLA C/PL NE

CÓDIGO	DESCRIPCIÓN
63946	65x25
63945	95x35



ANILLA C/PL HORIZONTAL NE

CÓDIGO	DESCRIPCIÓN
63947	65x25



ANILLA C/PL LISA NE

CÓDIGO	DESCRIPCIÓN
10015	60x22
00008	80x25
00009	105x30



ANILLA C/PL OXIDO

CÓDIGO	DESCRIPCIÓN
69377	25x80



ANILLA C/PL LISO 500-A ANTICUARIO

CÓDIGO	DESCRIPCIÓN
06574	64x42



ANILLA C/PL LISO HORIZ. 28-HA ANTIC.

CÓDIGO	DESCRIPCIÓN
06572	90x30



ANILLA C/PL LISO VERT 28-VA ANTIC.

CÓDIGO	DESCRIPCIÓN
06570	90x30



ASA C/PL ABATIBLE NE 73961

CÓDIGO	DESCRIPCIÓN
63949	95x35



ASA C/PL SALOMONICA NE 73872

CÓDIGO	DESCRIPCIÓN
00067	140x30



ASA C/PL SALOMONICA 150x30 73871

CÓDIGO	DESCRIPCIÓN
00068	NE
69196	OX.



ASA CONCHA LISA CI-264 NE

CÓDIGO	DESCRIPCIÓN
68803	83
68804	92



ASA TAN10 C/PLACA 155 ABATIBLE NE

CÓDIGO	DESCRIPCIÓN
06243	155





ASA TAN12 S/PLACA105 NE

CÓDIGO	DESCRIPCIÓN
06245	155



ASA TAN9 C/PLACA 150 ABATIBLE NE

CÓDIGO	DESCRIPCIÓN
06242	155



BOCALLAVE HORIZ NE 73962

CÓDIGO	DESCRIPCIÓN
10039	65x25



BOCALLAVE 65x25 NE 73963

CÓDIGO	DESCRIPCIÓN
10040	65x25



ESCUDO BOCALLAVE 90V NE VERTICAL

CÓDIGO	DESCRIPCIÓN
57002	65x25



POMO C/PL CRUZ NE 73875

CÓDIGO	DESCRIPCIÓN
00012	52x52



PÉNDULO C/PL LISO HORIZONTAL

CÓDIGO	DESCRIPCIÓN
00007	NE 105x30
69370	Ox. 105x30
10012	NE 60x22
00006	NE 80x25



PÉNDULO C/PL LISO

CÓDIGO	DESCRIPCIÓN
00004	NE 25x80
69373	Ox. 25x80
00005	NE 30x105
69372	Ox.30x105
10013	NE 60x22



PÉNDULO C/PL CRUZ NE

CÓDIGO	DESCRIPCIÓN
00114	60x60
00013	70x70



PÉNDULO C/PL LISO 500-P ANTIC.

CÓDIGO	DESCRIPCIÓN
06573	54x42



PÉNDULO C/PL LISO VERT 28-V ANTIC.

CÓDIGO	DESCRIPCIÓN
06569	90x30



PÉNDULO C/PL 73956/73954

CÓDIGO	DESCRIPCIÓN
64091	65x25
63948	95x35



PÉNDULO C/PL LISO HORIZ. 28-H ANTIC

CÓDIGO	DESCRIPCIÓN
06571	90x30



ROSETÓN NR NE RÚSTICO 34

CÓDIGO	DESCRIPCIÓN
02232	B3444BP0

ASA COMODILLA

ASA COMODILLA ELECTRA ZKNS

CÓDIGO	DESCRIPCIÓN
08342	70x35



ASA COMODILLA UCAF 80x35

CÓDIGO	DESCRIPCIÓN
54099	ZKCM
54091	ZKCS
54092	ZKORO



ASA CONCHA

TIRADOR CONCHA 64MM

CÓDIGO	DESCRIPCIÓN
65731	AF
65798	LP



TIRADOR CONCHA 64MM ZAMAK

CÓDIGO	DESCRIPCIÓN
22482	ZKCM
68384	ZKNS



TIRADOR CONCHA GDE 50 M050110

CÓDIGO	DESCRIPCIÓN
09968	CS



TIRADOR CONCHA AB-263/100 LP

CÓDIGO	DESCRIPCIÓN
65799	LP



ASA CONCHA C C NATURALE ARCILLA

CÓDIGO	DESCRIPCIÓN
67805	ARCILLA



ASA CONCHA C CH3 MARFIL DECORADA

CÓDIGO	DESCRIPCIÓN
67806	MARFIL



TIRADOR PORCELANA

TIRADOR 9770 96

CÓDIGO	DESCRIPCIÓN
07963	ESTAÑO RUST.
07731	BR+P6 DECO



TIRADOR 9821/0822-831 CRAQUELE/BR. RUSTICO

CÓDIGO	DESCRIPCIÓN
04610	128
04611	96



TIRADOR H-0018 ORO VIEJO-P1 DECO

CÓDIGO	DESCRIPCIÓN
12508	96MM



MALETERO LATÓN



MALETERO 100/4 22/97 CS

CÓDIGO	DESCRIPCIÓN
67650	CS



MALETERO 22/97 LP

CÓDIGO	DESCRIPCIÓN
54221	LP



MALETERO 23/95

CÓDIGO	DESCRIPCIÓN
05855	CS
55762	LP
69355	LP (532)



MALETERO 2448 CIM

CÓDIGO	DESCRIPCIÓN
03514	CIM



MALETERO 28/96

CÓDIGO	DESCRIPCIÓN
01571	BM
54212	LP



MALETERO 4419 AF

CÓDIGO	DESCRIPCIÓN
54208	AF



MALETERO 4424

CÓDIGO	DESCRIPCIÓN
67220	BM
67223	CS



MALETERO 4448

CÓDIGO	DESCRIPCIÓN
67234	BM
67237	CS



MALETERO 598

CÓDIGO	DESCRIPCIÓN
51960	LP
00042	LS
03834	NS



MALETERO 65/03

CÓDIGO	DESCRIPCIÓN
01640	BM
01639	CS



MALETERO 766 CASTA DIVA

CÓDIGO	DESCRIPCIÓN
02556	BM
03444	LP



MALETERO 88/96

CÓDIGO	DESCRIPCIÓN
63988	BM
67213	CIM



MALETERO AB-161

CÓDIGO	DESCRIPCIÓN
67108	CR
65736	ENVEJECIDO
65770	LP



MALETERO 680 AF-P6 CRAQUELE

CÓDIGO	DESCRIPCIÓN
09564	AF+P6

PLACA POMO LATÓN



PLACA POMO S/B 22/97 LP

CÓDIGO	DESCRIPCIÓN
54220	LP
67648	CS



PLACA POMO S/B 23/95

CÓDIGO	DESCRIPCIÓN
05854	CS (1532)
55761	LP
69353	LP (532)



PLACA POMO S/B 2448 CIM

CÓDIGO	DESCRIPCIÓN
03512	CIM



PLACA POMO S/B 28/96

CÓDIGO	DESCRIPCIÓN
01570	BM



PLACA POMO S/B 4419 AF

CÓDIGO	DESCRIPCIÓN
54206	AF



PLACA POMO S/B 598

CÓDIGO	DESCRIPCIÓN
51958	LP
00040	LS



PLACA POMO S/B 4424

CÓDIGO	DESCRIPCIÓN
67218	BM



PLACA POMO S/B 65/03

CÓDIGO	DESCRIPCIÓN
01637	BM
01636	CS



PLACA POMO S/B 680 AF-P6 CRAQUELE

CÓDIGO	DESCRIPCIÓN
09565	AF+P6



PLACA POMO S/B AB-162

CÓDIGO	DESCRIPCIÓN
65735	AF
67106	CR



PLACA POMO S/B 88/96

CÓDIGO	DESCRIPCIÓN
63986	BM
67211	CIM

MALETERO Y PLACA POMO INOX



MALETERO 5755 INOX

CÓDIGO	DESCRIPCIÓN
11051	INOX



PLACA POMO S/B 5756 INOX

CÓDIGO	DESCRIPCIÓN
11049	INOX

MALETERO Y PLACA POMO ESTILO ESPAÑOL



MALETERO 1024 NE

CÓDIGO	DESCRIPCIÓN
69746	NE



MALETERO 28 90x30

CÓDIGO	DESCRIPCIÓN
06564	ANTICUARIO
51739	NE



MALETERO LISO 25x90 OX 73880-O

CÓDIGO	DESCRIPCIÓN
69199	25x90



PLACA POMO C/B 1023 NE

CÓDIGO	DESCRIPCIÓN
69745	NE C/B
69744	NE S/B



PLACA POMO C/B 30 145x30

CÓDIGO	DESCRIPCIÓN
06566	ANTICUARIO
51740	NE



PLACA POMO C/B LISO 73881-O

CÓDIGO	DESCRIPCIÓN
69198	Ox. 30x150



PLACA POMO S/B 30 145x30

CÓDIGO	DESCRIPCIÓN
06565	ANTICUARIO
51738	NE



PLACA POMO S/B LISO OX 73879-O

CÓDIGO	DESCRIPCIÓN
69197	Ox. 30x150

KIT TIRADORES PUERTAS CORREDERAS

KIT TIRADOR EMBUTIR 2Y1

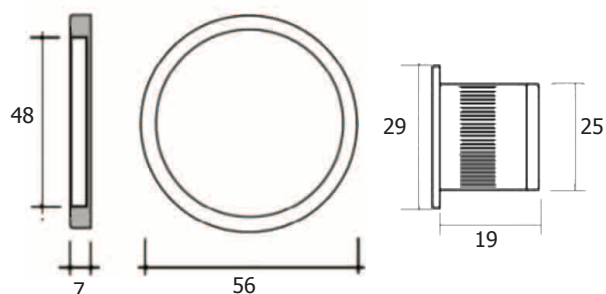

CÓDIGO	DESCRIPCIÓN
06538	CM
06707	CS
06715	LS
06706	LP
06717	NS



KIT TIRADOR EMBUTIR 2Y1C

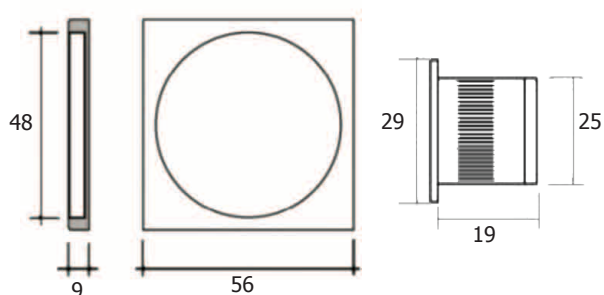

CÓDIGO	DESCRIPCIÓN
05377	CM
05378	LP
05380	LS
05415	NS
50104	CR



KIT TIRADOR EMBUTIR 2Y1 B/BORJA

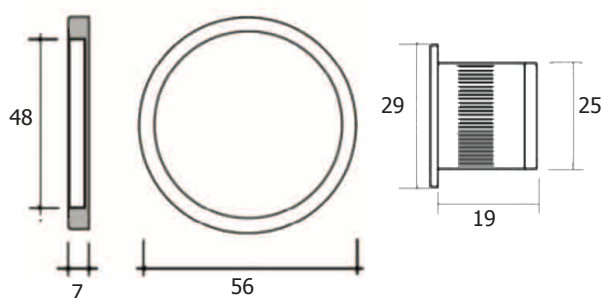

CÓDIGO	DESCRIPCIÓN
60111	LP
60110	NS



TIRADORES EMBUTIR PUERTAS CORREDERAS

TIRADOR EMBUTIR 3560-800 CM

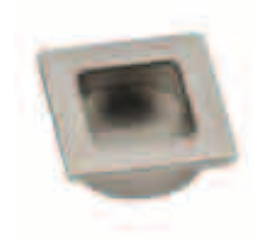

CÓDIGO	DESCRIPCIÓN
03445	50x50

TIRADOR EMBUTIR 3702-038 NS



CÓDIGO	DESCRIPCIÓN
05404	110

TIRADOR EMBUTIR 3801/3802 LATÓN Y DORADO



CÓDIGO	DESCRIPCIÓN
07704	115x42
07705	80x36

TIRADOR EMBUTIR 3922-038 NS



CÓDIGO	DESCRIPCIÓN
03407	110

TIRADOR EMBUTIR 3511



CÓDIGO	DESCRIPCIÓN
05605	Ø40 NS
02991	Ø40 ORO

TIRADOR EMBUTIR H-0107 ORO VIEJO



CÓDIGO	DESCRIPCIÓN
12512	110MM

ACCEDE A NUESTRA
TIENDA ONLINE



www.herrajesandalucia.com



www.herrajesandalucia.com

AVDA LA INDUSTRIA 15
POL.CRTA AMARILLA
C.P. 41007 Sevilla
Telf 954998540

SIERRA ATALAYA, 29
P.I.LA JUAIDA
C.P. 04240 Viator (Almería)
Telf 950306098