



HERRAJES DE ANDALUCÍA

CABINAS SANITARIAS



Herrajes y Accesorios

Los herrajes de la marca **Inox Art** están fabricados en Acero Inoxidable AISI 304, garantizando la máxima calidad y durabilidad.

AISI 304

El grado de acero inoxidable AISI 304 corresponde al grupo de acero inoxidable austenítico (no es magnético). Este grupo es el más indicado para las aplicaciones donde se requiere una gran resistencia a la corrosión, buena presencia y facilidad de limpieza.

El acero inoxidable austenítico es no magnético con lo que las partículas férricas y residuos magnéticos no se quedan adheridos facilitando la limpieza e impidiendo zonas de acumulación de residuos.

El acero inoxidable AISI 304 contiene un 18% de cromo y un 10% de níquel, con el cual se obtiene una buena resistencia a la corrosión en la mayoría de las aplicaciones.

ANÁLISIS QUÍMICO AISI 304 INOX ART

		AISI 304	AISI 304 INOX ART
CROMO	Cr	18.0 – 20.0%	18.3%
NIQUEL	Ni	8.0 – 10.5%	9.7%
CARBONO	C	0.08% Máximo	0.053%
MANGANESO	Mn	2.0% Máximo	1.09%
FOSFORO	P	0.045% Máximo	0.025%
AZUFRE	S	0.030% Máximo	0.03%
SILICIO	Si	0.75% Máximo	0.51%

ENSAYO:

Resistencia a la corrosión



RESULTADOS OBTENIDOS:

Clase 3 : Alta resistencia. Ambiente exterior donde puede existir humedad por lluvia o rocío

El criterio de evaluación de la superficie de las muestras se realiza según la norma
UNE EN 1670:2007 "Herrajes para edificación. Resistencia a la corrosión. Métodos y ensayo"
UNE 112017:92 "Test de corrosión en atmósferas artificiales (Cámara salina)"

Ensayo realizado a través del laboratorio independiente:

ASOCIADO N° 01842

 **AIDIMA**
 INSTITUTO TECNOLÓGICO
 MUEBLE, MADERA, EMBALAJE Y AFINES

Referencia: 1101033

Hoja de Encargo: 21100116

Bisagra Plana C/S Muelle WPF-05

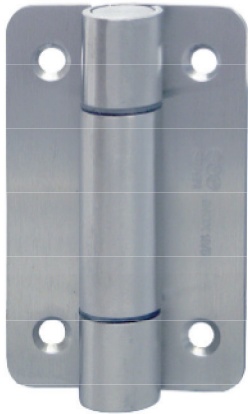

WPF-05B (Sin Muelle)

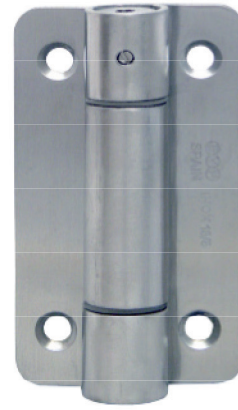
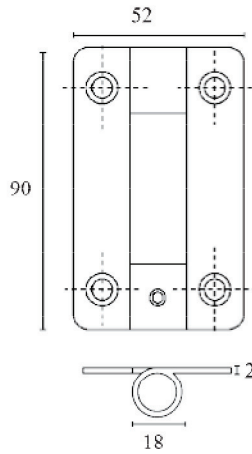

WPF-05C (Con Muelle)



Código Descripción

04329 Sin Muelle

04330 Con Muelle



Bisagra Plana Sin Muelle WPF-05D

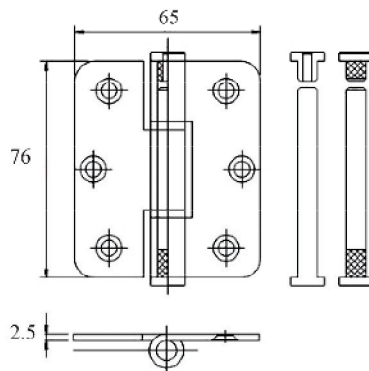

Código Descripción

08913 Sin Muelle

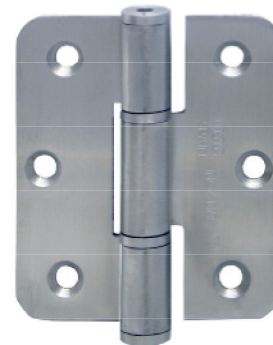

Unidad de bisagra plana para montaje enrasado o por tabla.



Bisagra Plana WPF

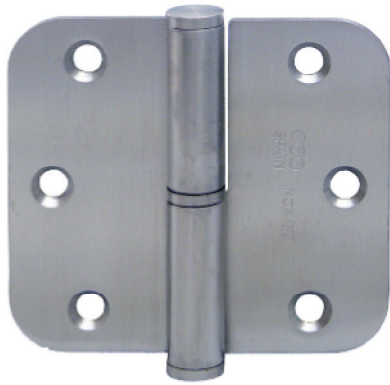

Código	Descripción
09499	Dcha
09500	Izda

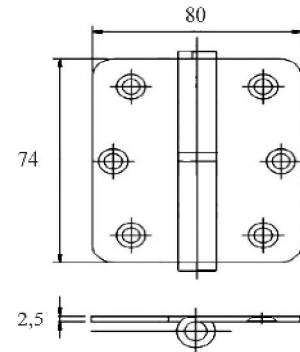

Bisagra Plana de acero inoxidable con mano. Medidas: 74x80x2.5



Pomo 25mm WPF-09A

Juego de pomos de 25mm de diámetro con fijación bis a bis mediante redondo rascado, tornillo Allen y sistema antihurto.

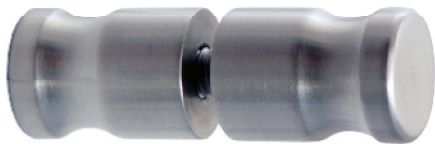

Código	Descripción
04333	WPF-09A

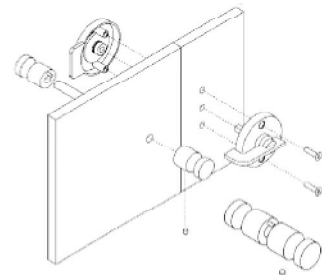
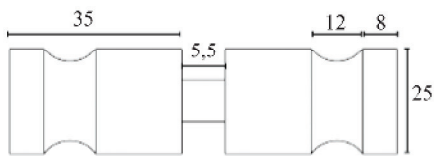



Pata Telescópica WPF-07

Unidad de soporte suelo-tablero regulable en altura con roseta de tornillos ocultos de 0.65mm. de diámetro de acero inoxidable.

Para taberos de 13mm.

Fijación al Suelo mediante tornillos y tacos.



Código	descripción
04331	AISI 304
09190	AISI 316

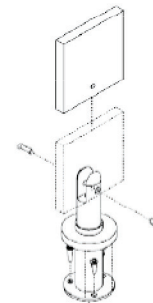
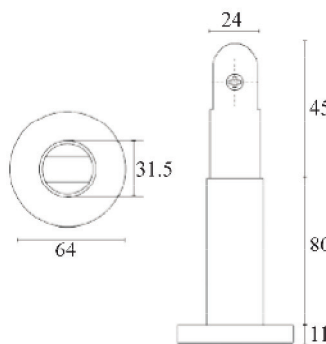

Suplemento Nylon Gris P/Pata Cabina

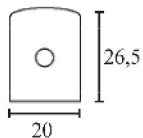

Código	Descripción
10732	Nylon



Muletilla con Desbloqueo WPF-06A

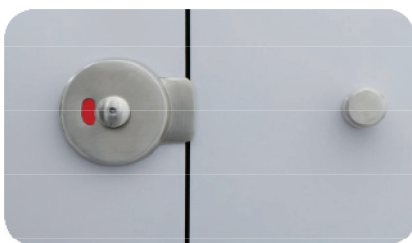

Código	Acabado
04332	WPF-06A

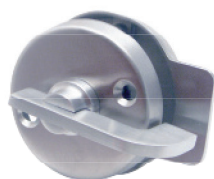
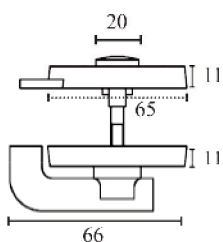
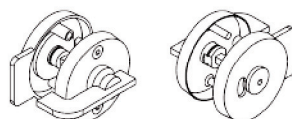
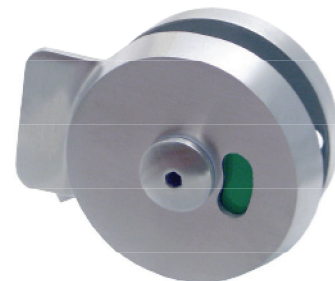

000

Set de condensa con desbloqueo exterior y señalizador libre-ocupado (indicador verde-rojo) WPF-06A con roseta de tornillos ocultos de Ø65mm, fijación mediante tornillos pasantes de acero inoxidable, para tablero de 13mm

Nudo Conector de Tubo 90° WPF-03



Código	Descripción
04334	WPF-03

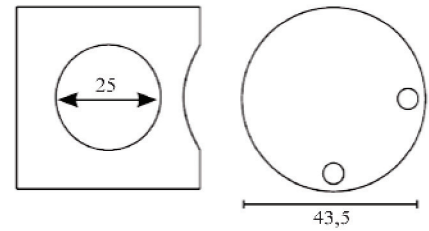

Unidad nudo conector de tubo a 90°. tubo Ø25mm

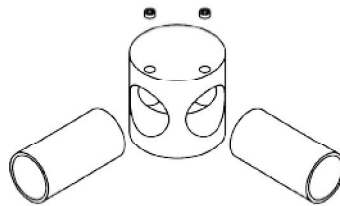

Nudo Conector de Tubo "T" 90°+90°



Código	Descripción
05188	WPF-03

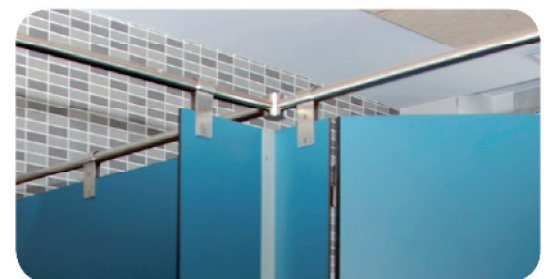
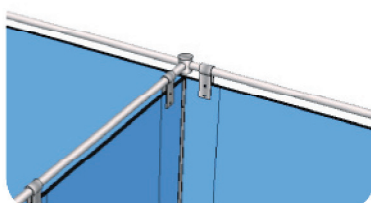
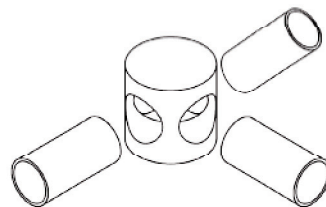
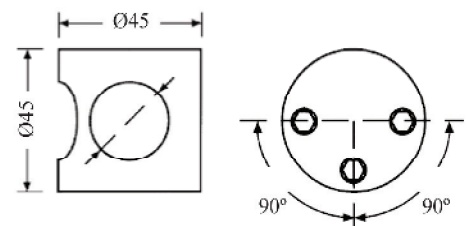



Soporte Tubo-Pared WPF-01

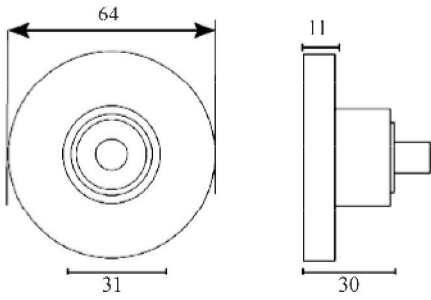

CÓDIGO	DESCRIPCIÓN
04327	WPF-01

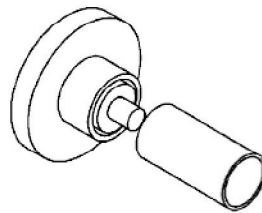

Unión Tubo Cabina

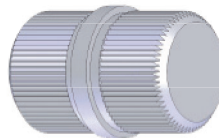
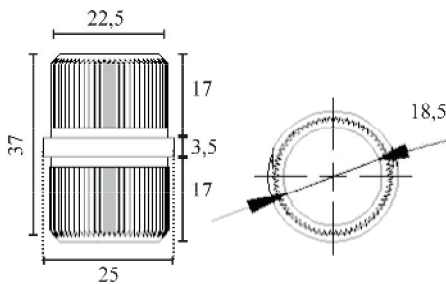

CÓDIGO	DESCRIPCIÓN
08417	CX06526



Tubo Cabina WPF-25



CÓDIGO	DESCRIPCIÓN
06152	2m
08724	3m



Tubo Inox Ø25



Pinza WPF-02



CÓDIGO	DESCRIPCIÓN
04328	WPF-02

Unidad de soporte tubo-tablero WPF-02 de acero inoxidable, para tablero de 13mm.

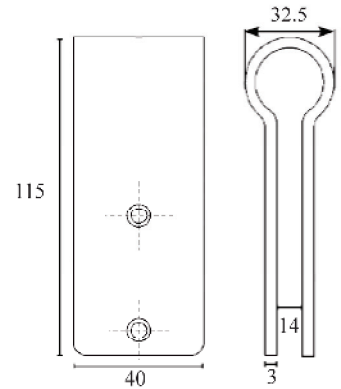

Inox Art



Pinza Lateral WPF-02B



Unidad de soporte tubo-tablero WPF-02B de acero inoxidable, para tablero de 13mm.

Código	Descripción
05187	WPF-02B

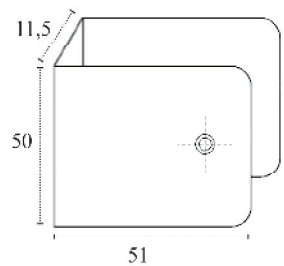

Inox Art



Escuadra a 90° WPF-04

Inox Art®

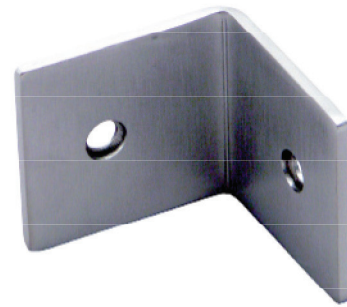
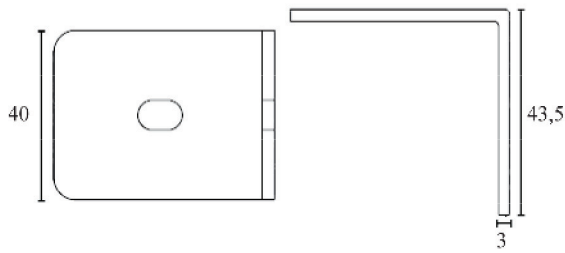
INOX
AISI 304

CÓDIGO	DESCRIPCIÓN
04335	WPF-04

Unidad de escuadra de unión para la formación de esquinas a 90°.

Escuadra “LU” WPF-21

Inox Art®

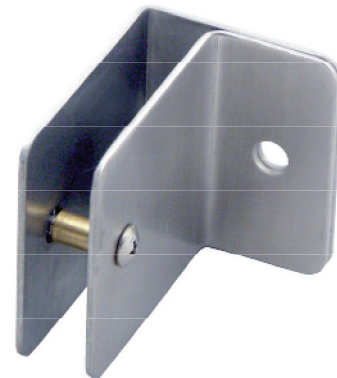
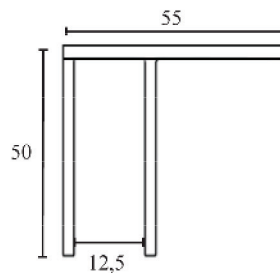
INOX
AISI 304

CÓDIGO	DESCRIPCIÓN
08451	WPF-21

50x50x2,0mm

Escuadra “TU” WPF-22

Inox Art®

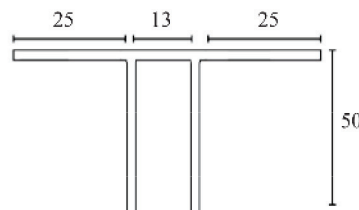
INOX
AISI 304

CÓDIGO	DESCRIPCIÓN
08450	WPF-22

50x50x2,0mm

Perfil "U" 180cm

Inox Art[®]

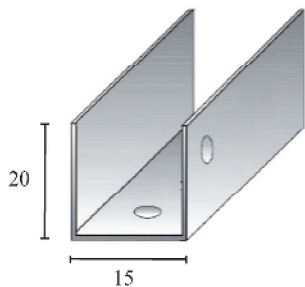

CÓDIGO	DESCRIPCIÓN
07116	180cm



Perfil "L" Exterior 180cm

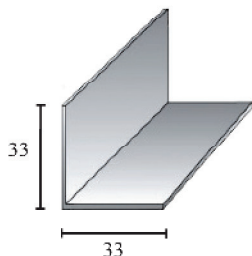
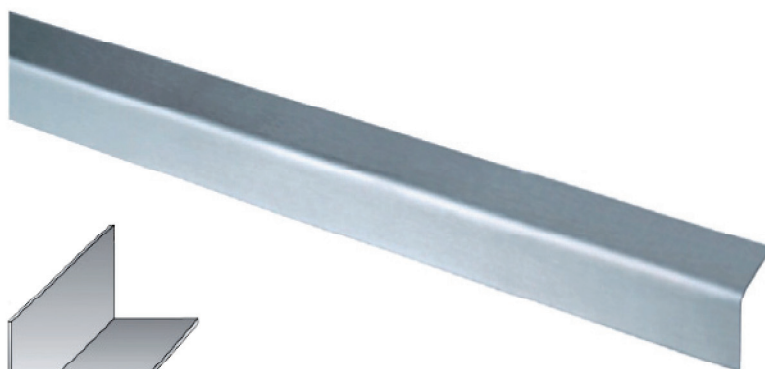

CÓDIGO	DESCRIPCIÓN
07114	180cm



Perfil "L" Interior 180cm

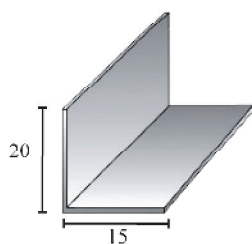

CÓDIGO	DESCRIPCIÓN
07115	180cm



Perfil Alto WPF 395cm Alinox

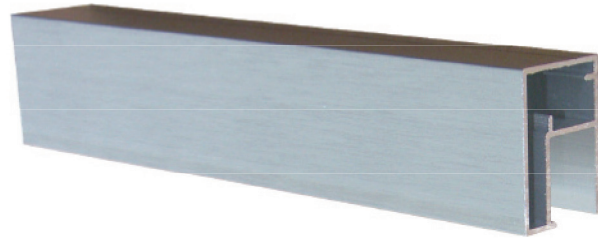
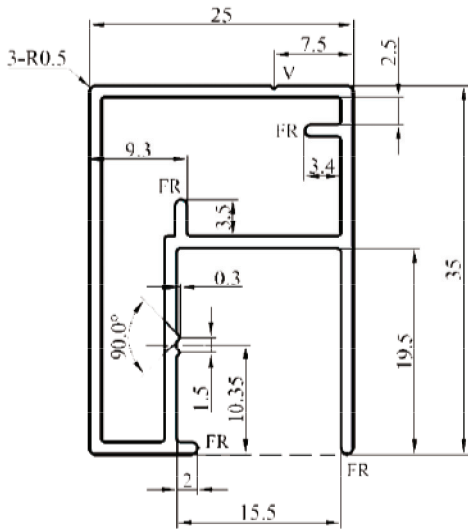

CÓDIGO	DESCRIPCIÓN
10525	395cm

Perfil U WPF Alinox

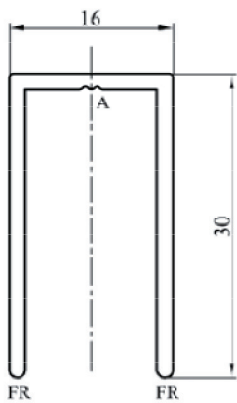

CÓDIGO	DESCRIPCIÓN
10526	180cm
10686	200cm

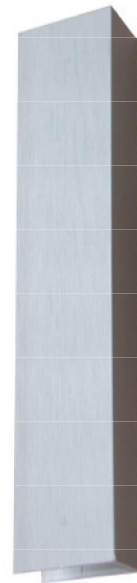
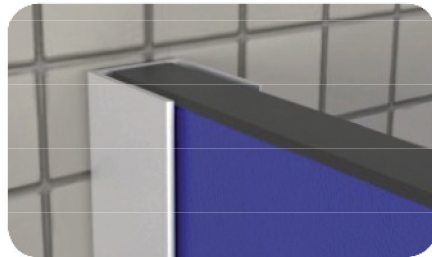

Tornillo Pasante Bisagra Cabina WPF-05

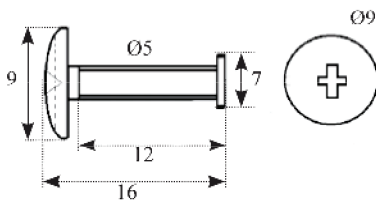

CÓDIGO	DESCRIPCIÓN
09903	12x5



Tornillo Bisagra Cabina

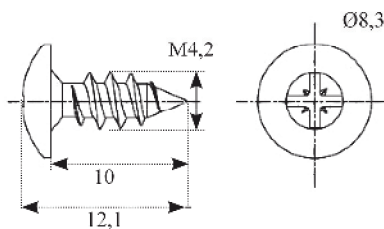

CÓDIGO	DESCRIPCIÓN
10578	10x4,2



Percha WPF-44



Inox Art

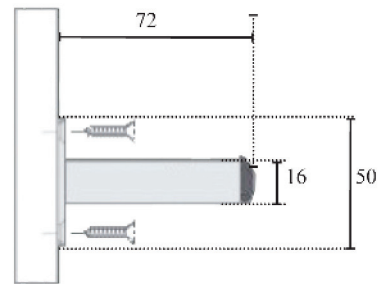

CÓDIGO	DESCRIPCIÓN
07656	WPF-44



Percha Simple



CÓDIGO	DESCRIPCIÓN
07131	Inox

Inox Art

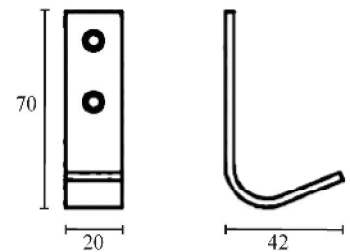

Percha Doble



CÓDIGO	DESCRIPCIÓN
07123	Inox

Inox Art

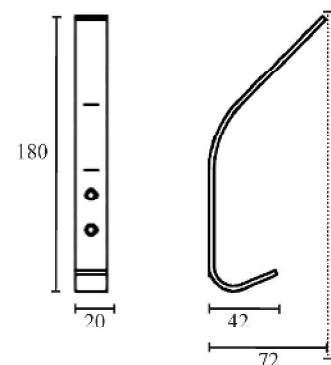

Set Cabina Corredera WPF-K20

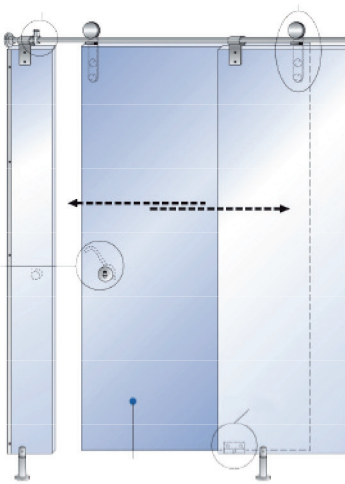

CÓDIGO	DESCRIPCIÓN
10241	Set WPF-K20

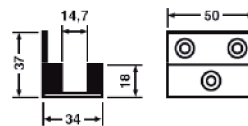
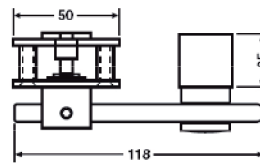
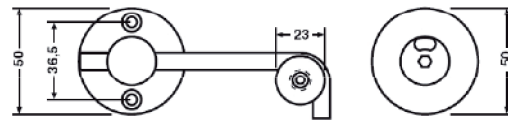
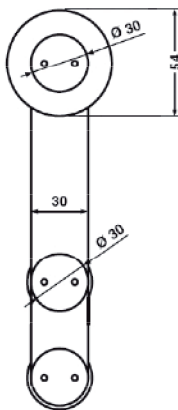
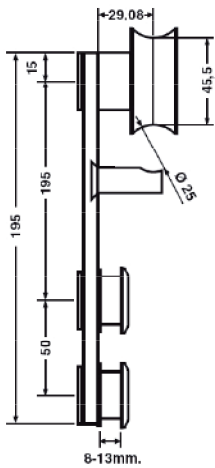
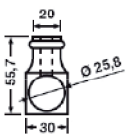

Muletilla Corredera WPF-K20



CÓDIGO	DESCRIPCIÓN
10242	Muletilla K20

Guiador Inferior WPF-K20



CÓDIGO	DESCRIPCIÓN
10243	Guiador Inf.

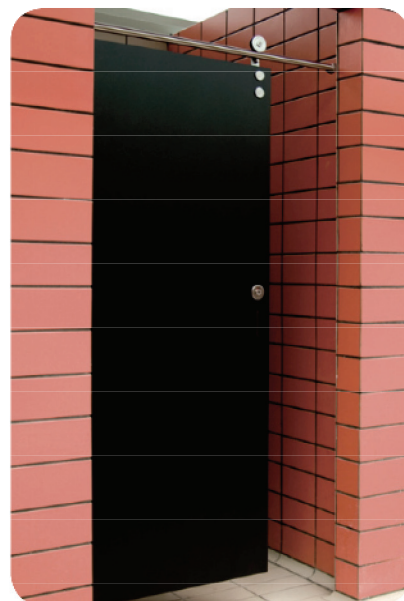



Perchas

07123 07131 07656

Soporte Tubo-Pared



04327 Perfil "U"



07116 10526 180cm
10686 200cm

Perfil Lateral



04328 Perfil Alto



10525

Tubo



06152 2m
08724 3m

Perfil "L"



07114 Ext. 07115 Int.

Bisagras



04330 04329 08913
09499 Dcha
09500 Izda

Unión Tubo



08417

Escuadras



08450 08451 05187 04335

Nudos Conectores



05188 04334

Muletilla



10242 04332

Pomo



04333

Pata

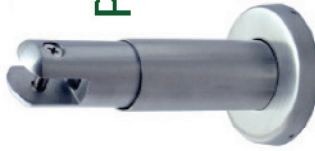

04331

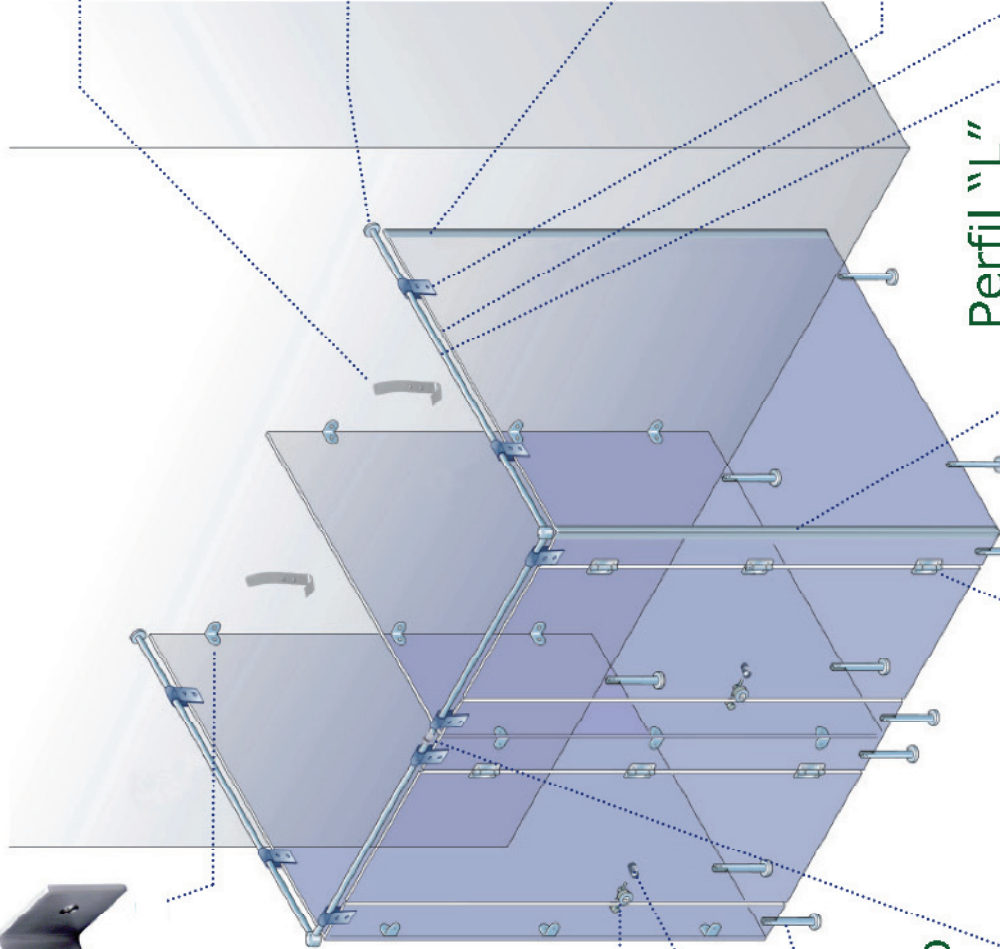



HERRAJES DE ANDALUCÍA

SEVILLA

Avda. de La Industria, 15
Pol. Ind. Carretera Amarilla
41007 Sevilla
Telf 954998540 - Fax 954998541
informacion@herrajesandalucia.com

ALMERÍA

C/ Sierra de Atalaya, 29
Pol. Ind. La Juaida
04240 Viator (Almería)
Telf 950306098 - Fax 954998541
administracion.almeria@herrajesandalucia.com