

jandel

CATÁLOGO TARIFA
2023



MANIVELAS
Y COMPLEMENTOS
PARA PUERTAS

jandel

¡ Bienvenid@ a casa !

Diferentes estilos

Diferentes necesidades

Diferentes series

UNA MISMA MARCA





DISEÑO FABRICACIÓN DISTRIBUCIÓN

Siguiendo las tendencias del mercado, Jandel presenta su nuevo catálogo aumentando la gama de productos en manivelas, manillones, pomos, tiradores y complementos.

Nuestro compromiso con los clientes y con la arquitectura hace que busquemos maneras nuevas y creativas de resolver los retos que se nos presentan cada día.

Buscamos la EXCELENCIA ya que aspiramos a los más altos estándares de calidad, eficiencia y servicio.

¡Gracias por acompañarnos en este camino.!



CUIDAMOS NUESTRO PLANETA

GESTIÓN DE RESIDUOS

En Jandel estamos comprometidos en disminuir los residuos generados como consecuencia de las actividades humanas, y así contribuir a reducir sus impactos a fin de minimizar los potenciales daños que causan al hombre y al medio ambiente.

DESENGRASE DE METÁLES

Para las industrias en las que el proceso de producción incluye la fabricación o montaje de componentes metálicos, es fundamental una limpieza efectiva de grasas, aceites, taladrinas, desmoldeantes, etc. Nuestros artículos pasan por diferentes equipos para realizar esta operación, siempre con lavado de agua y productos biodegradables.



CUIDAMOS LOS DETALLES

EMBALAJE ECOLÓGICO

El packaging de nuestros artículos es respetuoso con el medio ambiente.

Apostamos por embalajes ecológicos, por ello hemos implementado el uso de materiales reciclados y reciclables.



CERTIFICADO DE CALIDAD ISO 9001-2015

Es la norma internacional más reconocida.

Se centra en todos los elementos de administración de calidad con los que una organización debe contar para tener un sistema efectivo que le permita mejorar su productos y servicios. En Jandel estamos orgullosos de haber implantado esta norma.

TÉRMINOS Y CONDICIONES GENERALES DE VENTA (CGV)

1.- Ámbito de aplicación

Las presentes condiciones generales se aplicarán a todas las ventas y se entenderán aceptadas totalmente por los clientes por el sólo hecho de realizar un pedido, o aceptar una oferta.

2.- Precios.

Esta Tarifa anula las anteriores.

Los precios que en ella figuran se expresan en euros (€) y sin impuestos.

Esta tarifa permanecerá vigente en tanto no se comunique cualquier cambio por parte de Jandel S.L.

3.- Pedidos

El importe mínimo de un pedido deberá ser de 50,00 € (sin IVA).

Los modelos o acabados que NO figuran en esta tarifa quedan anulados o son susceptibles de consulta.

La mercancía viaja a Portes PAGADOS en:

Península y Baleares, para pedidos con importe = o superior a 300€ (sin IVA)

Canarias, Ceuta y Melilla, para pedidos con importe = o superior a 800€ (sin IVA)

4.- Entrega de las mercancías.

a) EL COMPRADOR DISPONDRÁ DE UN PLAZO MÁXIMO DE 5 DÍAS A PARTIR DE LA RECEPCIÓN DE LA MERCANCÍA PARA ENVIAR POR ESCRITO CUALQUIER RECLAMACIÓN POR DESPERFECTOS EN CALIDAD O DISCREPANCIA EN LA CANTIDAD ENVIADA.

b) en el caso de que se perciban daños exteriores en el embalaje de la mercancía, es NECESARIO que presente reservas a la agencia de transporte, y ésta lo refleje en el comprobante de entrega con una descripción detallada.

5.- Política de devoluciones de mercancía.

• Solo se contemplarán cambios o devoluciones si nuestros productos presentan algún tipo de TARA. Fuera de esta condición, únicamente se aceptarán aquellas devoluciones que estén autorizadas previamente por el departamento Comercial, siendo los costes del envío a cargo del comprador.

• La mercancía devuelta con antigüedad superior a dos años tendrá un RECARGO del 30% en concepto de manipulación y gastos de gestión.

• En toda devolución se tendrá que aportar el número de Albarán o Factura de compra.

• Quedan EXCLUIDOS, de la política de devoluciones los productos especiales o personalizados.

Es importante que sigan las "especificaciones de mantenimiento" que recomendamos:

< Para la limpieza de nuestros artículos barnizados, pasar sólo un paño seco, sin emplear ningún producto químico, ya que tales productos afectan a la composición del barniz alterando sus propiedades, y por tanto afectando la calidad de dicho artículo >

6.- Modo de pago.

El retraso en el pago de las facturas ocasionará la aplicación de intereses de DEMORA.

En el caso de producirse IMPAGADOS, hará que se RETENGAN los pedidos hasta la total cancelación del saldo a favor de Jandel sl.

La presentación por parte del comprador de disconformidades o reservas en la mercancía no exime de la obligación de pago de la Factura en la fecha acordada.

7.- Información contenida en catálogos y en la web.

La información contenida en la tarifa- catálogo y en su web, con respecto a las descripciones, imágenes y medidas tendrá un valor meramente orientativo y aproximado, de modo que la empresa no asumirá ninguna responsabilidad por las posibles inexactitudes que puedan existir.

Jandel, S.L. SE RESERVA EL Der. DE EFECTUAR CUALQUIER MODIFICACIÓN O ANULACIÓN DE MODELOS Y ACABADOS OFRECIDOS SIN PREVIA COMUNICACIÓN.

JANDEL PREMIUM	
Manivelas	16
Bases.....	29
Grisanes	30
Manillones	31
Alzantes.....	34
Complementos	36

JANDEL ORIGINAL	
Manivelas	44
Bases.....	73
Manillones	74
Grisanes	82
Pomos de puerta	84
Complementos	88

JANDEL EQUAL	
Manivelas	96
Manillones	114
Complementos	124
Accesorios Técnicos.....	133

JANDEL INOX	
Manivelas	135
Manillones	140
Complementos	148
Pomos	151

JANDEL TIRADORES MUEBLE.....	152
------------------------------	-----

INDICE

JANDEL PREMIUM

 NEW 1301 16	 NEW 3310 21	 6318 27	 NEW C338 33	 38BY 38
 NEW 1311 16	 3327 21	 6328 27	 NEW 102AL2 34	 38BO 38
 1320 16	 3337 22	 6338 28	 NEW 359AL2 34	 38WC 38
 NEW 1327 17	 3357 23	 6347 28	 NEW 168AL2 35	 39BY 38
 1348 18	 3367 23	 BASES 29	 NEW 13BY 36	 39BO 38
 1356 18	 3377 23	 CG66 30	 13BO 36	 39WC 38
 1358 18	 3378 24	 CG20 30	 13WC 36	 63BY 39
 1366 19	 3388 25	 G88C 30	 NEW MARIONWC 36	 63BO 39
 NEW 1369 19	 3398 25	 C349 31	 33BY 37	 63WC 39
 NEW 1379 19	 3720 25	 EQ-M802 31	 33BO 37	 01WC 39
 1388 20	 3766 26	 C327 31	 33WC 37	 03WC 39
 1397 20	 3887 26	 NEW C379 32	 37BY 37	 CXBY 40
 1398 20	 NEW 3889 26	 NEW C369 32	 37BO 37	 CXBO 40
 NEW 1399 21	 3976 KUBO 27	 NEW C348 33	 37WC 37	 CXBYC 40

JANDEL ORIGINAL

 CXBOC 40	 1023 44	 1224 47	 KAROL 50	 SV-R950 55
 C630 41	 1045 44	 1229 47	 EQ-R207 51	 SV-C650 55
 C635 41	 1059 44	 1234 47	 EQ-R208 51	 SV-C950 55
 7610 41	 1072 44	 1239 47	 EQ-R209 51	 3012 56
 7630 41	 1075 44	 1249 47	 EQ-R450 51	 3022 56
 75220 42	 1080 44	 1254 47	 NEW EQ-R653 51	 3070 56
 75200 42	 1082 45	 NEW 12TE 48	 NEW EQ-R657 51	 3080 56
 75420 42	 1090 45	 NEW 15TE 48	 EQ-R890 52	 3082 56
 75400 42	 1092 45	 NEW WCTE 48	 EQ-R891 52	 3413 56
 9510 43	 1105 45	 NEW HQTE 48	 EQ-R892 52	 3424 56
 9530 43	 1115 46	 NEW H2TE 48	 UOVO 54	 3429 57
 1209 46	 1264 50	 POLO PORCELANA 54	 3434 57	
 1213 46	 2040 50	 POLO 54	 3449 57	
 1219 46	 6042 50	 SV-R650 55	 3570 59	

INDICE

JANDEL ORIGINAL

































































 4513..... 59	 EQ-796..... 64	 PLACAS..... 73	 C327..... 78	 C209..... 87
 SV-PC65..... 59	 EQ-1599..... 64	 C302..... 74	 C322..... 79	 C605..... 88
 SVP650..... 59	 EQ-2733..... 65	 EQ-M890..... 74	 C326..... 79	 C606..... 88
 3223..... 60	 EQ-3800..... 65	 EQ-M891..... 74	 C359..... 81	 SV-BR25..... 88
 NEW  EQ-9690..... 60	 EQ-4402..... 66	 EQ-M892..... 74	 C800..... 81	 EQ-285Z..... 88
 NEW  EQ-9691..... 60	 EQ-4406..... 66	 C307..... 75	 CG75..... 82	 C608..... 89
 NEW  EQ-9692..... 60	 EQ-4419..... 67	 C308..... 75	 CGKA..... 82	 SV-CR50..... 89
 8045..... 61	 EQ-4423..... 68	 C309..... 75	 G13C..... 83	 C630..... 89
 1605..... 61	 EQ-4424..... 68	 C310 / C312..... 75	 SV-105P..... 84	 12BY..... 89
 NEW  4459..... 61	 EQ-4450..... 69	 C311..... 76	 C207..... 84	 SV-495..... 90
 EQ-100B..... 62	 EQ-8300..... 69	 C313..... 76	 C208..... 84	 C611..... 91
 EQ-297..... 62	 EQ-9500..... 70	 C316..... 76	 EQ-1085..... 85	 34BY..... 91
 EQ-330..... 63	 EQ-9501..... 70	 C320..... 77	 EQ-1095..... 85	 C635..... 91
 EQ-525..... 63	 EQ-9600..... 71	 C349..... 77	 C210..... 86	 C902..... 91

JANDEL EQUAL

 12WC..... 92	 EQ-202..... 96	 SV-R300..... 102	 SV-P150..... 108	 SV-P398..... 112
 C621..... 92	 EQ-203..... 96	 SV-R333..... 102	 SV-P200..... 108	 SV-P500..... 112
 34WC..... 92	 EQ-204..... 96	 SV-R350..... 102	 SV-P250..... 108	 SV-PP50..... 112
 SV-CC35..... 92	 EQ-205..... 96	 SV-R600..... 102	 SV-P300..... 108	 SV-M500..... 112
 7610..... 93	 EQ-206..... 97	 NEW SV-R700..... 103	 SV-P333..... 108	 SV-M150..... 114
 7630..... 93	 EQ-207..... 97	 SV-R800..... 103	 SV-P350..... 109	 SV-M350..... 114
 7510..... 93	 EQ-208..... 97	 NEW SV-R850..... 103	 SV-P600..... 109	 SV-M200..... 114
 7530..... 93	 EQ-209..... 97	 NEW EQ-R655..... 103	 NEW SV-P850..... 109	 SV-M335..... 115
 C410..... 94	 EQ-210..... 98	 NEW EQ-C150..... 104	 SV-P700..... 109	 EQ-M802..... 115
 C420..... 94	 EQ-868..... 98	 SV-C200..... 104	 SV-PC20..... 110	 SV-M600..... 115
 C450..... 94	 EQ-R150..... 101	 NEW SV-C350..... 104	 NEW SV-PC35..... 110	 NEW SV-MC15..... 116
 C460..... 94	 EQ-R200..... 101	 SV-C400..... 104	 SV-PC70..... 110	 SV-MC20..... 116
 NEW EQ-T490-91-92...95	 EQ-R204..... 101	 SV-C700..... 104	 SV-PC75..... 110	 NEW SV-MC35..... 116
 NEW EQ-A490-91-92...95	 SV-R250..... 101	 SV-C750..... 104	 SV-P400..... 110	 SV-M400..... 116

INDICE

JANDEL EQUAL

 EQ-M800..... 118	 SV-495..... 124	 SV-CCDC..... 127	 SV-A401..... 129	 BH-90RI..... 131
 EQ-M810..... 118	 EQ-1197..... 124	 SV-KITC..... 127	 PH-100D (DER.)... 130	 BI-90CD (DER.)... 131
 EQ-M831..... 118	 SV-BC15..... 125	 KITC20..... 127	 PH-100I (IZQ.) ... 130	 BI-90CI..... 131
 EQ-M861..... 118	 SV-BC25..... 125	 PICOLORO..... 127	 PH-95D (DER.) ... 130	 BI-80CD (DER.)... 131
 SV-M360..... 121	 SV-B303..... 125	 SV-KITB..... 128	 PH-95I (IZQ.) ... 130	 BI-80CI..... 131
 EQ-M802K..... 121	 SV-B308..... 125	 SV-KITBC..... 128	 PI-100D (DER.) ... 130	 BI-90RD (DER.)... 131
 SV-C150..... 122	 SV-CC35..... 125	 PU-47/PU-70... 128	 PI-100I (IZQ.)... 130	 BI-90RD (IZQ.)... 131
 SV-PP15..... 122	 SV-CC50..... 125	 SV-PSMN..... 128	 PI-95D (DER.) ... 130	 SV-PR..... 132
 SV-MP15..... 122	 C902..... 125	 MR-2542..... 129	 PI-95I (IZQ.)... 130	 SV-PC..... 132
 EQ-285Z..... 124	 SVDEDALC..... 126	 MR-3560..... 129	 BH-90CD (DER.) . 131	ACCESORIOS TÉCNICOS..... 133
 SV-BR25..... 124	 SVDEDALR..... 126	 SV-TOPE..... 129	 BH-90CI..... 131	
 SV-B304..... 124	 SV-CCDR..... 126	 SV-T150..... 129	 BH-80CD (DER.) . 131	
 SV-B305..... 124	 SV-KITR..... 126	 SV-A150..... 129	 BH-80CI..... 131	
 SV-CR50..... 124	 KITR20..... 126	 SV-T401..... 129	 BH-90RD..... 131	

JANDEL INOX

 SV-R302..... 135	 SV-X338..... 137	 SV-M318..... 140	 EQ-M810..... 146	 SV-B303..... 149
 SV-X302..... 135	 SV-G338..... 137	 SV-M338..... 140	 EQ-M831..... 146	 SV-B308..... 149
 SV-G302..... 135	 SV-P338..... 137	 SV-M258..... 140	 EQ-M801..... 147	 SV-B306..... 149
 SV-F302..... 135	 SV-P339..... 137	 SV-M365..... 140	 EQ-M802..... 147	 SV-1198..... 149
 SV-E302..... 135	 SV-R318 / SV-R358... 138	 SV-M360..... 140	 EQ-M802K..... 147	 HUELLA15..... 149
 SV-P301..... 135	 SV-P318..... 138	 SV-MP32..... 141	 SV-340..... 148	 HUELLA20..... 149
 SV-P302..... 135	 SV-P319..... 138	 SV-PP32..... 141	 SV-345..... 148	 TOPE INOX..... 149
 SV-R336..... 136	 SV-C334..... 138	 SV-LP30..... 141	 SV-348..... 148	 SV-8510..... 150
 SV-X336..... 136	 SV-P334..... 138	 SV-MF32..... 141	 SV-B304..... 148	 EQ-8610..... 150
 SV-G336..... 136	 SV-R258..... 139	 SV-LF30..... 141	 SV-B305..... 148	 SV-170P..... 151
 SV-F336..... 136	 SV-P258..... 139	 EQ-M861..... 142	 SV-B307..... 148	 SV-172P..... 151
 SV-P336..... 136	 SV-C413..... 139	 EQ-M851..... 144	 SV-B309..... 148	
 SV-P337..... 136	 SV-P413..... 139	 EQ-M841..... 145	 SV-346..... 149	
 SV-R338..... 137	 SV-M302..... 140	 EQ-M800..... 146	 SV-347..... 149	

INDICE

























JANDEL TIRADORES

 M04A 152	 M24/A/B/C 154	 H112 158	 H132 161
 M26A/B 152	 M25A 154	 H115 158	 H133 161
 M27A 152	 M29A 154	 H120 158	 H134 161
 M28A 152	 H55A/B 156	 H121 158	 H135 161
 M03A 152	 H76A 156	 H122 158	 H136 162
 M07A 152	 H93A/B 156	 H123 159	 H137 162
 M09A/B 152	 H94A 156	 H124 159	 H138 162
 M10A/B 153	 H95A/B 156	 H125 159	 H140 162
 M11A/B 153	 H102 156	 H126 160	 SV-HUELLA ... 162
 M12A/B/C 153	 H103 156	 H127 160	
 M13A/B/C 153	 H113 156	 H128 160	
 M14A/B/C/D 153	 H107 158	 H129 161	
 M22A/B/C 154	 H108 158	 H130 161	
 M23A/B/C/D/E/F/ G/H/I/J/K/L/M 154	 H111 158	 H131 161	

LEYENDA DE MATERIALES

LAT Latón
AL Aluminio
ZK Zamak
INOX Inox

LEYENDA DE ACABADOS

			
AN Anticato	AN.PL Anodizado Plata	ANTR Antracita	BL Blanco
			
CB Cromo Brillo	CC Cromo Combinado	CI Cuero Inglés	CO.ST Cobre Satinado
			
CS Cromo Satinado	CU Cuero	EFCS Efecto Cromo Satinado	EFLM Efecto Latón Mate
			
INOX	LM Latón Mate	MR Marrón	NE Negro
			
NM Níquel Mate	NM.OP Níquel Mate Opaco	NMM Níquel Mate Mate	NS Níquel Satinado
			
NS/NB Níq. Satin./Níq. Brillo	PB Pulido Brillo	PL Plata	PS Pulido Satinado
			
PVL M PVD Latón Mate			



NEW

1301 Plana ZK

Opciones	Ref.	ANTR	CB	CI	CS	NE	NM		
Ø50	1301	45.03	53.64	53.28	43.92	43.20	46.80	1	16
247	2301	87.48	104.40	84.60	82.80	86.40	87.84	1	12



NEW

1311 Cloe LAT

Opciones	Ref.	CB	CS	NE	PB		
Ø50	1311	91.80	87.12	88.92	87.12	1	16
247	2311	131.40	117.02	124.20	122.40	1	12



1320 Shape AL

Opciones	Ref.	ANTR	BL	CO.ST	EFCS	EFLM	NE	NM.OP		
Ø50	1320	34.92	31.40	34.92	34.92	34.92	31.40	34.92	1	24
247	2320	69.39	79.20	69.39	69.39	71.65	63.62	69.39	1	12



NEW

1327 Corsa ZK

Opciones	Ref.	ANTR	BL	CB	CS	NE	NM	NM.OP		
Ø50	1327	46.05	48.24	59.22	43.92	47.09	47.09	47.16	1	16
247	2327	90.03	91.80	106.92	84.60	88.56	90.03	88.56	1	12





1348 Marina New ZK

Opciones	Ref.	CB	PL		
Ø50	1348	61.53	73.44	1	16
247	2348	110.52	113.40	1	12



1356 Easy ZK

Opciones	Ref.	CB	CI	CS	NM		
Ø50	1356	58.50	50.42	41.70	44.12	1	16
247	2356	106.20	100.80	74.57	79.20	1	12



1358 Altwien LAT

Opciones	Ref.	CB	PB		
Ø50	1358	67.18	61.86	1	16
247	2358	111.60	85.44	1	12



1366 Olanda INOX

Opciones	Ref.	ANTR	BL	CB	EFLM	INOX	NE		
Ø50	1366	37.78	37.77	41.15	37.67	36.08	37.77	1	24
247	2366	81.02	72.29	71.40	81.02	75.60	68.37	1	12



NEW

1369 Marion LAT

Opciones	Ref.	CB	CI	LM	NE	NM	PB		
Ø50	1369	103.97	88.31	117.36	91.48	105.63	96.89	1	16
247	2369	142.20	138.60	133.20	129.60	140.76	133.20	1	12



NEW

1379 Inés LAT

Opciones	Ref.	BL	CB	CI	CS	LM	NE	NM	PB		
Ø50	1379	100.80	93.24	89.64	93.24	97.20	83.88	101.88	88.20	1	16
247	2379	144.01	140.40	118.80	122.40	118.80	127.80	129.60	135.02	1	12

- AN. PL Anodizado Plata
- ANTR Antracita
- BL Blanco
- CB Cromo Brillo
- CI Cuero Inglés
- CO.ST Cobre Satin.
- CU Cuero
- CS Cromo Satin.
- EFCS Efect. Cromo Satin.
- EFLM Efect. Latón Mate
- INOX
- LM Latón Mate
- NM Niq. Mate
- NMM Níquel Mate Mate
- NMOP Níquel Mat. Opaco
- NE Negro
- PB Pulido Brillo
- PL Plata



1388 Ice ZK

Opciones	Ref.	ANTR	BL	CB	CI	CS	NE	NM	NM.OP		
Ø50	1388	44.57	45.88	52.92	55.19	43.35	41.30	45.65	44.57	1	16
247	2388	90.02	94.68	104.40	97.20	84.60	86.40	92.88	90.02	1	12



1397 Adelle ZK

Opciones	Ref.	CB	CI	CS	NE	NM		
Ø50	1397	60.02	56.78	49.08	48.60	57.17	1	16
247	2397	115.20	97.92	90.02	93.60	87.34	1	12



1398 Slim ZK

Opciones	Ref.	ANTR	BL	CB	CS	NE	NM	NM.OP		
Ø50	1398	48.04	51.84	52.40	45.87	45.87	48.04	48.04	1	16
247	2398	87.34	88.20	102.60	87.34	78.63	79.20	92.16	1	12



NEW

1399 Punto ZK

Opciones	Ref.	ANTR	CB	CS	NE	NM		
Ø50	1399	52.56	68.04	51.12	51.48	57.60	1	16
247	2399	97.20	115.20	90.02	94.68	96.12	1	12



NEW

3310 Origami ZK

Opciones	Ref.	ANTR	BL	CB	CS	NE	NM		
50x50	3310	57.60	64.80	74.52	58.68	57.60	66.96	1	16
248	4310	81.03	84.60	106.20	81.72	83.52	84.60	1	12



3327 Corsa ZK

Opciones	Ref.	ANTR	BL	CB	CS	NE	NM	NM.OP		
50x50	3327	41.69	41.69	51.05	41.22	41.69	44.18	42.09	1	16
248	4327	54.40	72.98	78.20	57.90	51.60	59.55	54.40	1	12



3337 Viper ZK

Opciones	Ref.	BL	CB	CI	CS	NE	NM		
50x50 5	3337	60.48	60.71	82.53	58.50	56.09	59.84	1	16
248 40	4337	93.60	87.10	106.20	75.10	70.35	79.32	1	12



3357 Flake ZK

Opciones	Ref.	ANTR	CB	CI	NE	NM	NM.OP		
50x50 5	3357	41.69	51.05	55.19	41.69	40.90	41.69	1	16
248 40	4357	72.02	87.48	73.44	70.20	72.02	54.40	1	12

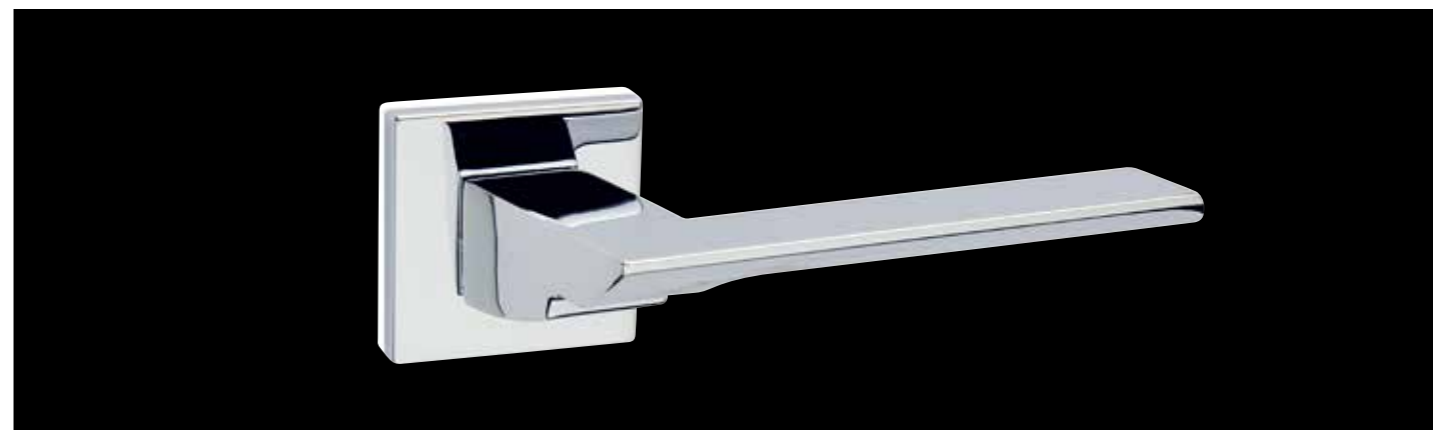

3367 Italia ZK

Opciones	Ref.	ANTR	BL	CB	CS	NE		
50x50 5	3367	41.69	45.04	51.05	41.22	40.58	1	16
248 40	4367	72.02	73.80	87.48	69.12	70.20	1	12



3377 Pura ZK

Opciones	Ref.	ANTR	BL	CB	CS	NE	NM.OP		
50x50 5	3377	41.69	45.04	51.05	41.22	40.58	41.69	1	16
248 40	4377	72.02	73.80	87.48	69.12	70.20	72.02	1	12

-
-
-
-
-
-
-
-
-
-
-
-
-
-
-
-
-
-



3378 Swarovski LAT

Opciones	Ref.	CB		
50x50 5	3378	141.38	1	16
248 40	4378	180.88	1	12

Con cristal de Swarovski



3388 Ice ZK

Opciones	Ref.	ANTR	BL	CB	CI	CS	NE	NM	NM.OP		
50x50 5	3388	46.30	47.17	54.26	55.59	45.04	43.68	46.30	46.30	1	16
248 40	4388	67.31	75.60	83.88	81.02	69.12	59.94	75.60	73.80	1	12



3398 Slim ZK

Opciones	Ref.	ANTR	BL	CB	CS	NE	NM	NM.OP		
50x50 5	3398	57.19	57.19	55.44	48.04	48.04	50.22	50.22	1	16
248 40	4398	75.60	79.20	82.80	72.00	73.08	75.60	75.60	1	12



3720 Shape AL

Opciones	Ref.	ANTR	BL	CO.ST	EFCS	EFLM	NE	NM.OP		
Ø25 2	3720	27.90	23.51	34.28	27.90	27.90	23.51	27.90	1	24
247 45	2320	69.39	79.20	69.39	69.39	71.65	63.62	69.39	1	12

- AN, PL Anodizado Plata
- ANTR Antracita
- BL Blanco
- CB Cromo Brillo
- CI Cuero Inglés
- CO.ST Cobre Satin.
- CU Cuero
- CS Cromo Satin.
- EFCS Efect. Cromo Satin.
- EFLM Efect. Latón Mate
- INOX
- LM Latón Mate
- NM Niq. Mate
- NMM Níquel Mate Mate
- NMOP Níquel Mat. Opaco
- NE Negro
- PB Pulido Brillo
- PL Plata



3766 Olanda INOX

Opciones	Ref.	BL	CB	INOX	NE		
Ø25	3766	36.69	30.60	25.64	31.43	1	24
247	2366	72.29	71.40	75.60	68.37	1	12



3887 Infinity ZK

Opciones	Ref.	CS	NE		
52X35	3887	111.93	111.93	1	16



NEW

3889 Futura AL

Opciones	Ref.	AN.PL	NE		
52X35	3889	198.03	198.03	1	16



3976 Kubo AL

Opciones	Ref.	ANTR	BL	EFCS	NE	NM.OP		
25X25	3976	34.74	31.22	34.74	31.22	34.74	1	24
248	4376	68.40	67.68	68.40	53.82	63.98	1	12



6318 Juliette LAT

Opciones	Ref.	CI	PB	PL		
Ø50	6318	74.06	75.24	77.22	1	16
247	2318	106.92	106.92	104.55	1	12







6328 Vittoria LAT

Opciones	Ref.	CI	NE	PL		
Ø50	6328	76.83	77.22	86.73	1	16
247	2328	100.80	84.95	119.88	1	12







6338 Rodi LAT

Opciones	Ref.	CB	PB		
 Ø50 10	6338	111.68	111.68	1	16
 247 45	2338	193.54	193.54	1	12



6347 Calliope ZK

Opciones	Ref.	CB	CI	CS	NM	PB	PL		
 Ø50 10	6347	41.69	45.43	37.91	44.57	45.04	64.26	1	16
 247 45	2347	82.98	79.02	75.60	79.20	81.66	104.55	1	12

Estas referencias se pueden montar con todas las manivelas y en todos los acabados de nuestra serie **Jandel Premium**

PLACAS

23 LAT

Placa manivela



43 LAT

Placa manivela



00 LAT

Placa manivela sin muelle



ROSETAS

CXC

60 x 30 x 10 mm
Roseta rect.
Con muelle



CX

60 x 30 x 10 mm
Roseta oval
Con muelle



GRISÁN

GC

64 x 30 x 10 mm
Placa grisán
DK rectangular



G

64 x 30 x 10 mm
Placa grisán
DK oval



Ref.	ANTR	BL	CB	CI	CO.ST	CS	EFCS	EFLM	INOX	LM	NE	NM	NM.OP	PB	PL
23	16.64	15.53	17.73	19.83	16.64	17.09	16.64	19.20	-	19.52	15.53	16.64	16.64	20.16	23.68
43	12.80	12.80	19.24	16.96	-	11.65	12.80	-	-	-	11.65	13.60	12.80	-	-
00	14.12	13.44	13.60	13.12	14.12	13.60	14.12	14.12	-	12.68	14.44	14.44	14.12	12.48	18.56
GC	12.48	11.52	12.32	12.48	-	12.32	12.48	-	-	-	11.52	12.80	12.48	-	-
G	10.56	9.28	10.40	10.56	10.56	10.40	10.56	10.56	9.92	9.92	12.39	10.88	10.56	9.92	15.33
CXC	16.64	15.68	16.48	16.64	-	16.48	16.64	-	-	-	15.68	17.12	16.64	-	-
CX	11.20	10.24	11.04	11.20	11.20	11.04	11.20	11.20	10.56	10.56	10.44	11.68	11.20	10.56	16.32

-  AN. PL Anodizado Plata
-  CB Cromo Brillo
-  CU Cuero
-  EFLM Efect. Latón Mate
-  NM Niq. Mate
-  NE Negro
-  ANTR Antracita
-  CI Cuero Inglés
-  CS Cromo Satin.
-  INOX
-  NMM Níquel Mate Mate
-  PB Pulido Brillo
-  BL Blanco
-  CO.ST Cobre Satin.
-  EFCS Efect. Cromo Satin.
-  LM Latón Mate
-  NMOP Níquel Mat. Opaco
-  PL Plata

Grisanes

Tarifa de precios 2023 (€)



Ref.	BL	CB	INOX	NE	
CG66 INOX	19.20	21.12	17.28	17.64	1

Ref.	ANTR	BL	CO.ST	EFC.S	EFLM	NE	NM.OP	
CG20 AL	16.20	15.49	20.00	20.00	16.20	15.49	16.20	1

Ref.	ANTR	BL	CB	CI	CS	NE	NM	NM.OP	
G88C ZK	24.64	26.08	26.88	25.60	23.36	23.68	25.60	24.64	1



Manillones

Tarifa de precios 2023 (€)

Ref.	mm (entre cent.)	BL	CB	INOX	NE	
EQ-M802 INOX	Ø25 (200)	57.60	64.45	26.95	29.03	2



Ref.	mm (entre cent.)	BL	CB	CO.ST	CS	EFLM	NE	NMM	
C349 ZK	200	20.16	20.16	39.47	19.56	39.47	20.16	19.56	2

Ref.	mm (entre cent.)	ANTR	BL	CB	CI	CO.ST	CS	EFLM	LM	NE	NM	NMM	PB	
C327 ZK	210	21.75	21.75	20.68	20.68	39.92	20.68	39.92	20.68	22.03	20.68	21.24	20.68	2

JANDEL PREMIUM

JANDEL PREMIUM



NEW

Ref.	mm (entre cent.)	BL	CB	CI	CS	LM	NE	NM	PB	
C379 LAT	Ø20 (250)	107.20	100.80	92.80	92.80	92.80	80.02	100.80	99.20	1



NEW

Ref.	mm (entre cent.)	CB	CI	LM	NE	NM	PB	
C369 LAT	Ø22 (300)	235.84	235.84	232.32	211.20	235.84	232.32	1



NEW

Ref.	mm (entre cent.)	CB	PL	
C348 ZK	210	118.08	121.60	1



NEW

Ref.	mm (entre cent.)	CB	PB	
C338 LAT	265	140.80	137.60	1

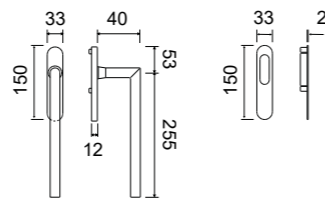

NEW

Ref.	ANTR	BL	INOX	NE	
102AL2 INOX	75.84	75.84	63.36	72.02	2

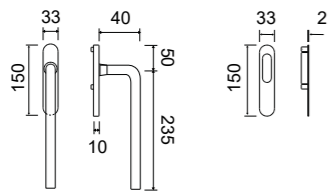

NEW

Ref.	AN	CB	CI	CS	NE	NM	PB	
359AL2 LAT	163.47	178.34	163.47	178.34	188.20	153.53	153.53	2

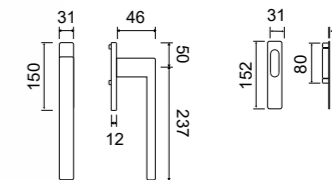

NEW

Ref.	ANTR	BL	CS	NE	
168AL2 ZK	144.02	147.20	134.40	137.60	2



Serie 13 roseta Ø50x5 mm



Bocallaves ZK

Ref.	ANTR	BL	CB	CI	CO.ST	CS	EFCS	EFLM	INOX	LM	NE	NM	NM.OP	PB	PL	
13BY	5.09	5.46	3.89	3.89	5.46	3.83	5.09	6.47	4.29	4.63	5.09	5.09	5.09	4.63	8.69	10
13BO	5.09	5.46	3.89	3.89	5.46	3.83	5.09	6.47	4.29	4.63	5.09	5.09	5.09	4.63	8.69	10



Condenas ZK

Ref.	ANTR	BL	CB	CI	CO.ST	CS	EFCS	EFLM	INOX	LM	NE	NM	NM.OP	PB	PL	
13WC	22.37	23.11	19.22	19.59	25.51	19.17	22.37	25.51	19.84	20.71	22.37	25.51	22.37	20.71	31.05	5



NEW

Condenas LAT

Ref.	CB	CI	LM	NE	NM	PB	
MARIONWC	26.88	26.88	28.90	27.56	27.56	26.18	5

Serie 33 roseta 50x50x5 mm



Bocallaves ZK

Ref.	ANTR	BL	CB	CI	CS	NE	NM	NM.OP	
33BY	5.84	6.18	5.57	5.75	4.42	5.30	5.30	6.18	10
33BO	5.84	6.18	5.57	5.75	4.42	5.30	5.30	6.18	10



Condenas ZK

Ref.	ANTR	BL	CB	CI	CS	NE	NM	NM.OP	
33WC	24.36	25.41	23.30	32.84	20.84	23.65	22.76	26.47	5

Serie 37 roseta Ø25x2 mm



Bocallaves ZK

Ref.	mm	ANTR	BL	CB	CO.ST	EFCS	EFLM	NE	NM.OP	
37BY	40x25x2	14.98	15.33	14.98	16.58	16.26	16.26	14.80	14.98	10
37BO	25x2	4.77	5.12	4.77	6.37	6.05	6.05	4.77	4.80	10



Condenas LAT

Ref.	ANTR	BL	CB	CO.ST	EFCS	EFLM	INOX	NE	NM.OP	
37WC	21.02	21.19	20.52	25.22	21.02	21.02	23.68	18.60	21.02	5

Serie 38 roseta 52x40x10 mm



Bocallaves ZK

Ref.	CS	NE	
38BY	7.06	7.06	10
38BO	7.06	7.06	10



Condenas LAT

Ref.	CS	NE	
38WC	26.12	27.17	5

Serie 39 roseta 25x25x2 mm



Bocallaves ZK

Ref.	mm	ANTR	BL	EFCS	NE	NM.OP	
39BY	40x25x2	14.98	15.33	16.26	14.98	15.99	10
39BO	25x25x2	5.35	5.46	6.63	4.34	5.35	10



Condenas LAT

Ref.	ANTR	BL	EFCS	NE	NM.OP	
39WC	24.03	22.95	24.03	20.68	24.03	5

Serie 63 roseta Ø50x10 mm



Bocallaves LAT

Ref.	CB	CI	CS	NE	NM	PB	PL	
63BY	8.76	9.16	8.76	8.32	8.95	8.76	11.40	10
63BO	8.76	9.16	8.76	8.32	8.95	8.76	11.40	10



Condenas LAT

Ref.	CB	CI	CS	NE	NM	PB	PL	
63WC	30.92	32.11	35.40	28.32	32.53	30.21	39.04	5

Roseta 35 mm



Condenas roseta Ø35x7 mm LAT

Ref.	ANTR	BL	CB	CI	CO.ST	CS	EFCS	EFLM	LM	NE	NM	NM.OP	PB	PL	
01WC	25.29	29.57	29.57	31.43	25.89	21.04	25.29	25.29	25.89	25.29	31.43	25.29	25.89	32.61	5



Condenas roseta 35x35x7 mm LAT

Ref.	ANTR	BL	CB	CI	CS	NE	NM	NM.OP	
03WC	29.54	33.23	26.60	33.28	25.84	29.54	29.54	29.54	5

- AN. PL Anodizado Plata
- ANTR Antracita
- BL Blanco
- CB Cromo Brillo
- CI Cuero Inglés
- CO.ST Cobre Satin.
- CU Cuero
- CS Cromo Satin.
- EFCS Efect. Cromo Satin.
- EFLM Efect. Latón Mate
- INOX
- LM Latón Mate
- NM Niq. Mate
- NMM Níquel Mate Mate
- NMOP Níquel Mat. Opaco
- NE Negro
- PB Pulido Brillo
- PL Plata

Roseta oval 60x30x10 mm

NEW

CXBY ZK

Ref.	ANTR	BL	CB	CI	CO.ST	CS	EFCs	EFLM	NE	NM	NM.OP	PB	PL	
CXBY	10.40	9.41	8.64	8.01	10.40	8.64	10.40	10.40	9.41	9.28	10.40	8.01	12.80	10



NEW

CXBO ZK

Ref.	ANTR	BL	CB	CI	CO.ST	CS	EFCs	EFLM	NE	NM	NM.OP	PB	PL	
CXBO	10.40	9.41	8.64	8.01	10.40	8.64	10.40	10.40	9.41	9.28	10.40	8.01	12.80	10



Roseta rectangular 60x30x10 mm

NEW

CXBYC ZK

Ref.	ANTR	BL	CB	CI	CO.ST	CS	EFCs	EFLM	NE	NM	NM.OP	PB	PL	
CXBYC	10.88	9.92	10.56	10.24	10.88	10.56	10.88	10.88	9.92	11.68	10.88	9.92	17.60	10



NEW

CXBOC ZK

Ref.	ANTR	BL	CB	CI	CO.ST	CS	EFCs	EFLM	NE	NM	NM.OP	PB	PL	
CXBOC	10.88	9.92	10.56	10.24	10.88	10.56	10.88	10.88	9.92	11.68	10.88	9.92	17.60	10



Bocallaves de seguridad (puerta de entrada)



C630 roseta Ø50x10 mm (seguridad) LAT

Ref.	ANTR	BL	CB	CI	CS	LM	NE	NM	NMM	PB	PL	
C630	6.96	8.29	8.29	8.29	8.29	8.29	8.29	8.29	6.96	8.29	6.96	10



C635 roseta 50x50x10 mm (seguridad) LAT

Ref.	ANTR	BL	CB	CI	CS	LM	NE	NM	NMM	PB	
C635	7.43	8.29	8.29	7.43	8.29	7.43	8.29	8.29	7.43	7.43	10



Kit redondo Ø56 mm (Ø48 interior) LAT

Ref.	ANTR	BL	CB	CI	CO.ST	CS	EFLM	LM	NE	NM	NM.OP	PB	PL	
7610	19.59	18.50	21.45	21.73	22.18	21.45	23.52	23.57	18.50	22.47	22.18	22.24	42.85	1



Kit cuadrado 56x56 mm (Ø48 interior) LAT

Ref.	ANTR	BL	CB	CI	CS	LM	NE	NM	NM.OP	PB	
7630	20.90	19.20	26.12	24.71	26.12	27.11	19.22	34.08	24.04	26.43	1

- AN. PL Anodizado Plata
- ANTR Antracita
- BL Blanco
- CB Cromo Brillo
- CI Cuero Inglés
- CO.ST Cobre Satin.
- CU Cuero
- CS Cromo Satin.
- EFCs Efect. Cromo Satin.
- EFLM Efect. Latón Mate
- INOX
- LM Latón Mate
- NM Niq. Mate
- NMM Níquel Mate Mate
- NMOP Níquel Mat. Opaco
- NE Negro
- PB Pulido Brillo
- PL Plata

Kits correderas



Opciones	Ref.	ANTR	BL	CB	CI	CS	CU	LM	NE	NM	NM.OP	PB	🔌
125-40	7.5220	22.18	22.85	24.40	23.66	24.40	24.04	22.99	23.40	27.36	22.18	22.99	1
125-40	7.5200	51.01	52.49	54.92	53.60	54.92	50.64	49.54	49.90	54.92	51.01	49.54	1
125-40	7.5420	24.04	24.40	25.73	25.89	25.73	25.89	23.30	23.66	25.89	24.04	23.30	1
125-40	7.5400	51.75	53.23	55.46	51.75	55.46	51.75	50.64	51.01	54.92	51.75	50.64	1



Kit redondo c/condena Ø56 mm (Ø48 interior) ZK

Ref.	BL	CB	CS	CU	LM	NE	NM	PB	🔌
9510	34.82	34.82	34.82	34.82	34.82	34.82	34.82	34.82	1



Kit cuadrado c/condena 56x56 mm (Ø48 interior) ZK

Ref.	BL	CB	CS	LM	NE	NM	PB	🔌
9530	34.82	34.82	34.82	34.82	34.82	34.82	34.82	1

- AN. PL Anodizado Plata
- ANTR Antracita
- BL Blanco
- CB Cromo Brillo
- CI Cobre Inglés
- CO.ST Cobre Satin.
- CS Cromo Satin.
- EFCS Efect. Cromo Satin.
- EFLM Efect. Latón Mate
- INOX
- LM Latón Mate
- NM Niq. Mate
- NMM Níquel Mate Mate
- NMOP Níquel Mat. Opaco
- NE Negro
- PB Pulido Brillo
- PL Plata



1023 Gótica LAT

Opciones	Ref.	CI	PL		
Ø50	1023	79.10	109.19	1	20
280	8023	95.48	126.02	1	20

1045 Flexa LAT

Opciones	Ref.	CI	CS	LM	NM	PB		
Ø50	1045	50.58	58.11	50.58	60.95	49.04	1	20
241	1545	50.58	58.47	50.58	60.95	49.04	1	20

1082 Kubic LAT

Opciones	Ref.	CC	CS	LM	NM	PB		
Ø50	1082	89.57	89.57	81.65	89.57	81.65	1	20
241	1582	89.57	89.57	81.65	89.57	81.65	1	20

1090 Marina LAT

Opciones	Ref.	CS	LM	NM		
Ø50	1090	64.12	54.98	65.38	1	20
241	1590	64.12	54.98	65.38	1	20



1059 Air ZK

Opciones	Ref.	AN	CI	NE	PL		
Ø50	1059	18.89	18.89	18.89	18.89	1	20
265	4459	35.45	34.05	34.54	35.45	1	20

1072 Nuri LAT

Opciones	Ref.	CI	CS	LM	NM	PB		
Ø50	1072	50.58	58.11	50.58	60.95	54.72	1	20
241	1572	50.58	58.11	50.58	60.95	54.72	1	20

1092 Tekna ZK

Opciones	Ref.	CS	NM		
Ø50	1092	58.58	61.35	1	20
241	1592	58.58	61.35	1	20

1105 Gaudel LAT

Opciones	Ref.	CI	CS	LM	NM	PB		
Ø50	1105	28.64	32.94	28.64	32.94	28.64	1	20
241	1605	48.24	55.48	48.24	58.11	46.77	1	20



1075 Corinne LAT

Opciones	Ref.	CI	CU	LM	MR	NM	PB	PL		
Ø50	1075	59.04	59.04	28.54	59.04	28.54	28.54	28.54	1	20
241	1575	60.52	60.52	48.54	60.52	48.54	48.54	48.54	1	20

1080 Pilar LAT

Opciones	Ref.	CC	CI	CS	LM	NM	PB		
Ø50	1080	81.40	66.96	81.40	66.96	84.64	65.67	1	20
241	1580	81.40	66.96	81.40	66.96	84.64	65.67	1	20

- AN Anticato
- ANTR Antracita
- BL Blanco
- CB Cromo Brillo
- CC Cromo Combinado
- CI Curo Inglés
- CS Cromo Satinado
- CU Cuero
- LM Latón Mate
- MR Marrón
- NE Negro
- NM Níquel Mate
- NMM Níquel Mate Mate
- NM.OP Níq. Mat. Opaco
- NS Níquel Satinado
- PB Pulido Brillo
- PS Pulido Satin.
- PL Plata
- PVL M PVD Lat. Mate

JANDEL ORIGINAL

JANDEL ORIGINAL



1115 Venere LAT

Opciones	Ref.	CB	CI	CS	LM	NM		
Ø50	1115	34.96	30.40	34.96	30.40	34.96	1	20
241	1615	61.49	53.14	61.49	53.14	63.94	1	20



1209 Eva ZK

Opciones	Ref.	ANTR	CB	CS	NE	PVLM		
Ø50	1209	24.80	24.34	24.34	24.80	65.18	1	20
241	1509	44.80	44.34	44.34	44.80	85.18	1	20



1213 Elle ZK

Opc.	Ref.	ANTR	BL	CB	CI	CS	LM	NE	NM	PVLM		
Ø50	1213	24.80	24.34	24.34	24.34	24.34	24.34	24.34	24.34	67.38	1	20
241	1513	44.80	44.34	44.34	44.34	44.34	44.34	44.34	44.34	87.38	1	20



1219 Laia ZK

Opciones	Ref.	CB	CS	NE	NM		
Ø50	1219	24.34	24.34	24.34	24.34	1	20
241	1519	44.34	44.34	44.34	44.34	1	20



1224 Juan ZK

Opciones	Ref.	CB	CS	NM		
Ø50	1224	24.34	24.34	24.34	1	20
241	1524	44.34	44.34	44.34	1	20



1229 Dolce ZK

Opciones	Ref.	CB	CS	NE	NMM		
Ø50	1229	26.07	26.07	26.07	26.07	1	20
241	1529	46.07	46.07	46.07	46.07	1	20



1234 Virgo ZK

Opciones	Ref.	CB	CS	NE	NM		
Ø50	1234	23.94	23.94	23.94	23.94	1	20
241	1534	43.94	43.94	43.94	43.94	1	20



1239 Susi ZK

Opciones	Ref.	CB	CS	NE	NMM		
Ø50	1239	25.56	25.56	25.56	25.56	1	20
241	1539	45.56	45.56	45.56	45.56	1	20



1249 Clubb ZK

Opciones	Ref.	ANTR	BL	CB	CI	CS	NE	NMM		
50	1249	23.94	23.94	23.94	23.94	23.94	23.94	23.94	1	20
241	1549	43.94	43.94	43.94	43.94	43.94	43.94	43.94	1	20



1254 Aria ZK

Opciones	Ref.	CB	CS	NM		
Ø50	1254	24.34	24.34	24.34	1	20
241	1554	44.34	44.34	44.34	1	20







- AN Anticato
- ANTR Antracita
- BL Blanco
- CB Cromo Brillo
- CC Cromo Combinado
- CI Cuero Inglés
- CS Cromo Satinado
- CU Cuero
- LM Latón Mate
- MR Marrón
- NE Negro
- NM Níquel Mate
- NMM Níquel Mate Mate
- NM.OP Níq. Mat. Opaco
- NS Níquel Satinado
- PB Pulido Brillo
- PS Pulido Satin.
- PL Plata
- PVLM PVD Lat. Mate

JANDEL ORIGINAL



















JANDEL ORIGINAL

NEW

12TE ZK

Opciones	Ref.	BL	CI	LM	NE	NM		
	12TE	33.34	33.34	33.34	33.34	33.34	1	20
	15TE	53.34	53.34	53.34	53.34	53.34	1	20
	WCTE	15.34	15.34	15.34	15.34	15.34	2	40
	HQTE	5.95	5.95	5.95	5.95	5.95	10	200
	H2TE	11.04	11.04	11.04	11.04	11.04	5	100



-  AN Anticato
-  CB Cromo Brillo
-  CS Cromo Satinado
-  MR Marrón
-  NMM Níquel Mate Mate
-  PB Pulido Brillo
-  PVL M PVD Lat. Mate
-  ANTR Antracita
-  CC Cromo Combinado
-  CU Cuero
-  NE Negro
-  NM.OP Níq. Mat. Opaco
-  PS Pulido Satin.
-  BL Blanco
-  CI Cuero Inglés
-  LM Latón Mate
-  NM Níquel Mate
-  NS Níquel Satinado
-  PL Plata



1264 Heavy ZK

Opciones	Ref.	CB	CS	NM		
Ø50	1264	24.34	24.34	24.34	1	20
241	1564	44.34	44.34	44.34	1	20



2040 Línea LAT

Opciones	Ref.	CS	LM	NM		
Ø50	2040	63.36	55.73	65.88	1	20
241	2540	63.94	59.04	68.87	1	20



6042 Polaris LAT

Opciones	Ref.	CC	CI	CS	CU	LM	NM	PB	PS		
Ø50	6042	56.31	46.80	56.31	46.80	46.80	58.86	46.80	46.80	1	20
241	1542	56.31	46.80	56.31	46.80	46.80	58.86	46.80	46.80	1	20



Karol ZK

Opciones	Ref.	CI	LM	NM	PB		
Ø50	KAROL ROSETA	40.83	45.26	55.12	40.83	1	20
241	KAROL PLACA	40.83	45.26	55.12	40.83	1	20



EQ-R207 ZK

Opciones	PB		
Ø50	16.67	1	20



EQ-R208 ZK

Opciones	CU		
Ø50	16.67	1	20



EQ-R209 ZK

Opciones	NM		
Ø50	16.67	1	20



EQ-R450 LAT

Opciones	CU	PB		
Ø50	24.60	24.60	1	20



NEW Tapa Pomos

EQ-R653 ZK

mm	CS	NE	NM		
Ø 65	28.78	28.78	28.78	1	20



NEW Tapa Pomos

EQ-R657 ZK

mm	CU	NE	NM	PB		
Ø 65	24.34	24.34	24.34	24.34	1	20

- AN Anticato
- ANTR Antracita
- BL Blanco
- CB Cromo Brillo
- CC Cromo Combinado
- CI Cuero Inglés
- CS Cromo Satinado
- CU Cuero
- LM Latón Mate
- MR Marrón
- NE Negro
- NM Níquel Mate
- NMM Níquel Mate Mate
- NM.OP Níq. Mat. Opaco
- NS Níquel Satinado
- PB Pulido Brillo
- PS Pulido Satin.
- PL Plata
- PVL M PVD Lat. Mate

JANDEL ORIGINAL

JANDEL ORIGINAL



EQ-R890 LAT

Opciones	AN	CI	CU	NM	PB	PL		
Ø50 10	37.63	37.63	37.63	37.63	37.63	37.63	1	20

*Porcelana craquelé



EQ-R891 LAT

Opciones	AN	CI	CU	NM	PB	PL		
Ø50 10	37.63	37.63	37.63	37.63	37.63	37.63	1	20

*Porcelana beige



EQ-R892 LAT

Opciones	AN	CI	CU	NM	PB	PL		
Ø50 10	37.63	37.63	37.63	37.63	37.63	37.63	1	20

*Porcelana blanca



- AN Anticato
- CB Cromo Brillo
- CS Cromo Satinado
- MR Marrón
- NMM Níquel Mate Mate
- PB Pulido Brillo
- PVLN PVD Lat. Mate
- ANTR Antracita
- CC Cromo Combinado
- CU Cuero
- NE Negro
- NM.OP Níq. Mat. Opaco
- PS Pulido Satin.
- BL Blanco
- CI Cuero Inglés
- LM Latón Mate
- NM Níquel Mate
- NS Níquel Satinado
- PL Plata

JANDEL ORIGINAL

JANDEL ORIGINAL



Uovo LAT

Opciones	Ref.	CB	CI	CS	CU	LM	NM	PB	🔌	🔒
Ø50 [C] 10 [F]	UOVO ROSETA	92.34	82.16	92.34	82.16	82.16	94.79	82.16	1	20
241 [C] 42 [F]	UOVO PLACA	92.34	82.16	92.34	82.16	82.16	94.79	82.16	1	20



Polo PORCELANA (sin muelle) LAT

Opciones	Ref.	CI	NM	PB	🔌	🔒
Ø50 [C] 10 [F]	POLO PORC. ROSETA	94.79	104.87	94.79	1	20
241 [C] 42 [F]	POLO PORC. PLACA	94.79	10.487	94.79	1	20



Polo LAT

Opciones	Ref.	CB	CI	CS	CU	LM	NM	PB	🔌	🔒
Ø50 [C] 10 [F]	POLO ROSETA	92.34	82.16	92.34	82.16	82.16	94.79	82.16	1	20
241 [C] 42 [F]	POLO PLACA	92.34	82.16	92.34	82.16	82.16	94.79	82.16	1	20



SV-R650 ZK

Opciones	CB	CS	NM	🔌	🔒
Ø50 [C] 10 [F]	24.85	24.85	24.85	1	20



SV-R950 ZK

Opciones	NM	🔌	🔒
Ø50 [C] 10 [F]	29.61	1	20



SV-C650 ZK

Opciones	CB	CS	NM	🔌	🔒
50x50 [C] 10 [F]	25.72	25.72	25.72	1	20



SV-C950 ZK

Opciones	NM	🔌	🔒
50x50 [C] 10 [F]	32.19	1	20



- AN Anticato
- ANTR Antracita
- BL Blanco
- CB Cromo Brillo
- CC Cromo Combinado
- CI Cuero Inglés
- CS Cromo Satinado
- CU Cuero
- LM Latón Mate
- MR Marrón
- NE Negro
- NM Níquel Mate
- NMM Níquel Mate Mate
- NM.OP Níq. Mat. Opaco
- NS Níquel Satinado
- PB Pulido Brillo
- PS Pulido Satín.
- PL Plata
- PVL M PVD Lat. Mate

JANDEL ORIGINAL

JANDEL ORIGINAL

Manivelas



3012 Laura LAT

Opciones	Ref.	CB	CC	CS	NM	Icono 1	Icono 2
50x50 [Icono]	3012	91.88	91.88	91.88	95.08	1	20
269 [Icono]	3512	127.08	127.08	127.08	130.22	1	20
241 [Icono]	4512	96.59	96.59	96.59	100.84	1	20

3022 Natalia LAT

Opciones	Ref.	CB	CC	CS	NM	Icono 1	Icono 2
50x50 [Icono]	3022	91.88	91.88	91.88	95.08	1	20
269 [Icono]	3522	127.08	127.08	127.08	130.22	1	20
241 [Icono]	4522	96.59	96.59	96.59	100.84	1	20



3070 Iber LAT

Opciones	Ref.	CC	CI	CS	NM	Icono 1	Icono 2
50x50 [Icono]	3070	95.98	83.02	95.98	99.54	1	20
269 [Icono]	3570	126.47	117.65	126.47	136.16	1	20
241 [Icono]	4570	101.02	88.10	101.02	104.58	1	20

3080 Pilar LAT

Opciones	Ref.	CC	CI	CS	LM	NM	PB	Icono 1	Icono 2
50x50 [Icono]	3080	95.98	81.11	95.98	81.11	99.54	79.85	1	20
269 [Icono]	3580	131.15	111.50	131.15	111.50	134.82	110.24	1	20
241 [Icono]	4580	101.02	86.19	101.02	86.19	104.58	84.89	1	20



3082 Kubic LAT

Opc.	Ref.	CB	CC	CS	LM	NM	PB	Icono 1	Icono 2
50x50 [Icono]	3082	93.46	93.46	93.46	83.63	93.46	83.63	1	20
269 [Icono]	3582	126.90	126.90	126.90	117.08	126.90	117.08	1	20
241 [Icono]	4582	98.39	98.39	98.39	96.45	98.39	96.45	1	20

3413 Elle ZK

Opc.	Ref.	ANTR	BL	CB	CI	CS	LM	NE	NM	PVLM	Icono 1	Icono 2
50x50 [Icono]	3413	27.78	27.78	27.78	27.78	27.78	27.78	27.78	27.78	81.78	1	20
269 [Icono]	3513	-	-	67.93	67.93	67.93	67.93	67.93	67.93	-	1	20
241 [Icono]	4513	54.37	53.31	58.81	54.37	58.81	54.37	61.27	61.27	114.14	1	20

Manivelas



3424 Juan ZK

Opciones	Ref.	CB	CS	NM	Icono 1	Icono 2
50x50 [Icono]	3424	27.78	27.78	27.78	1	20
269 [Icono]	3524	67.93	67.93	67.93	1	20
241 [Icono]	4524	50.18	50.18	50.18	1	20

3429 Dolce ZK

Opciones	Ref.	CB	CS	NE	NMM	Icono 1	Icono 2
50x50 [Icono]	3429	30.02	30.02	30.02	30.02	1	20
269 [Icono]	3529	70.17	70.17	70.17	-	1	20
241 [Icono]	4529	52.42	52.42	52.42	52.42	1	20



3434 Virgo ZK

Opciones	Ref.	CB	CS	NE	NM	Icono 1	Icono 2
50x50 [Icono]	3434	27.78	27.78	27.78	27.78	1	20
269 [Icono]	3534	67.93	67.93	67.93	67.93	1	20
241 [Icono]	4534	50.18	50.18	50.18	50.18	1	20

3449 Clubb ZK

Opciones	Ref.	BL	CB	CS	NE	NMM	Icono 1	Icono 2
50x50 [Icono]	3449	30.02	30.02	30.02	30.02	30.02	1	20
269 [Icono]	3549	-	70.17	70.17	70.17	-	1	20
241 [Icono]	4549	52.42	52.42	52.42	52.42	52.42	1	20





- AN Anticato
- ANTR Antracita
- BL Blanco
- CB Cromo Brillo
- CC Cromo Combinado
- CI Curo Inglés
- CS Cromo Satinado
- CU Cuero
- LM Latón Mate
- MR Marrón
- NE Negro
- NM Níquel Mate
- NMM Níquel Mate Mate
- NM.OP Níq. Mat. Opaco
- NS Níquel Satinado
- PB Pulido Brillo
- PS Pulido Satin.
- PL Plata
- PVLM PVD Lat. Mate

JANDEL ORIGINAL

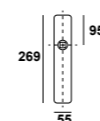
JANDEL ORIGINAL



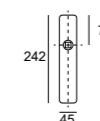

3570 LAT

CC	CI	CS	NM		
126.47	117.65	126.47	136.16	1	20



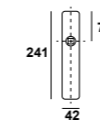

SV-PC65 ZK

CB	CS	NM		
29.45	27.40	30.85	1	20



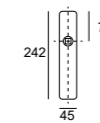

4513 LAT-ZK

ANTR	BL	CB	CC	CI	CS	LM	NE	NM	PVLM		
54.37	53.41	58.81	65.38	54.37	58.81	54.37	61.27	61.27	114.14	1	20



SV-P650 ZK

CB	CS	NM		
29.80	28.38	29.80	1	20

- AN Anticato
- ANTR Antracita
- BL Blanco
- CB Cromo Brillo
- CC Cromo Combinado
- CI Cuero Inglés
- CS Cromo Satinado
- CU Cuero
- LM Latón Mate
- MR Marrón
- NE Negro
- NM Níquel Mate
- NMM Níquel Mate Mate
- NM.OP Níq. Mat. Opaco
- NS Níquel Satinado
- PB Pulido Brillo
- PS Pulido Satin.
- PL Plata
- PVLM PVD Lat. Mate

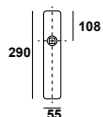

3223 LAT

CI	PB		
124.67	124.67	1	20

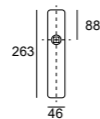

NEW

EQ-9690 LAT

CI		
55.98	1	20

*Porcelana craquelé

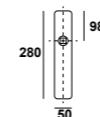
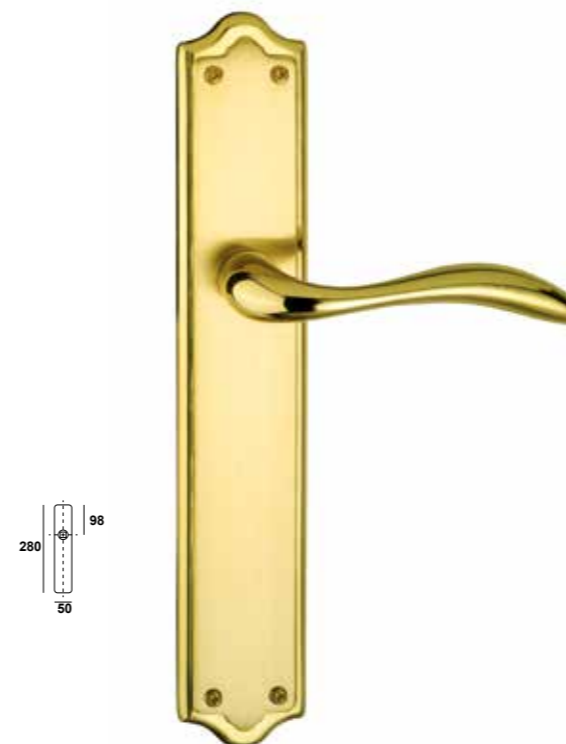

8045 LAT

CI	NM	PS		
67.02	77.76	67.02	1	20

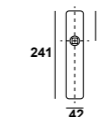
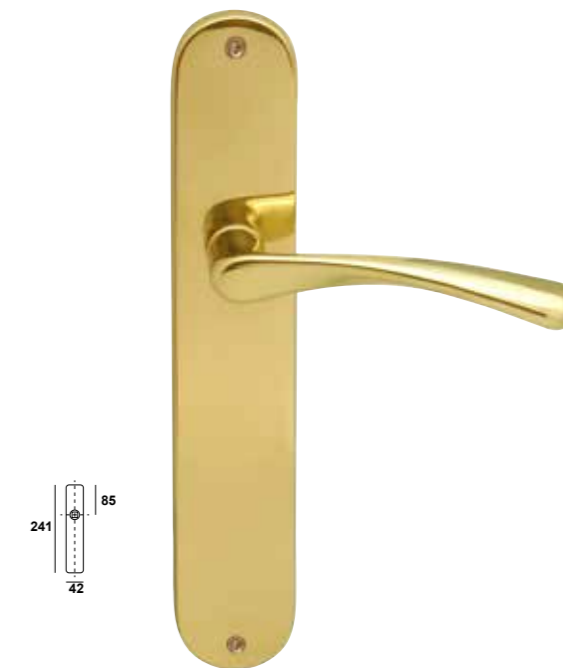

1605 LAT

CI	CS	LM	NM	PB		
48.24	55.48	48.24	58.11	46.77	1	20

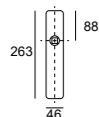
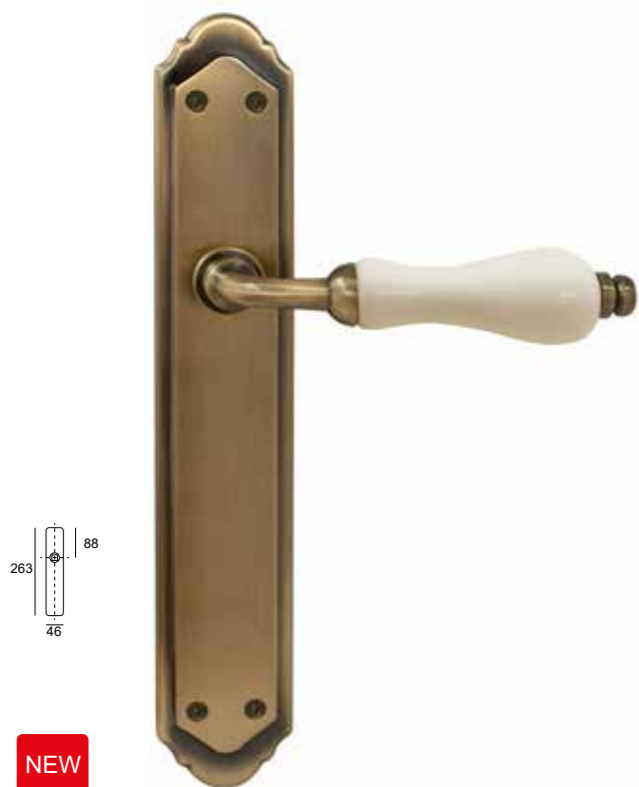

NEW

EQ-9691 LAT

CI		
55.98	1	20

*Porcelana beige

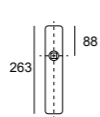

NEW

EQ-9692 LAT

CI		
55.98	1	20

*Porcelana blanca

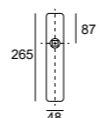

NEW

4459 LAT-ZK

AN	CI	NE	PL		
35.45	34.05	34.54	35.45	1	20



- AN Anticato
- ANTR Antracita
- BL Blanco
- CB Cromo Brillo
- CC Cromo Combinado
- CI Cuero Inglés
- CS Cromo Satinado
- CU Cuero
- LM Latón Mate
- MR Marrón
- NE Negro
- NM Níquel Mate
- NMM Níquel Mate Mate
- NM.OP Níq. Mat. Opaco
- NS Níquel Satinado
- PB Pulido Brillo
- PS Pulido Satin.
- PL Plata
- PVLN PVD Lat. Mate

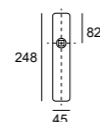

Ref.	Opciones	mm	PB		
EQ-100B	Jgo. Manivela	248x45	22.29	1	20
EQ-M100	Manillón	248x45	15.60	2	40
EQ-L100	Placa limpieza	248x45	6.83	10	100
EQ-C100	Asa corta c/placa	248x45	15.60	2	40
EQ-T203	Tirador armario	123x35	3.83	20	200
EQ-A203	Tirador maletero	83x35	2.78	20	200
EQ-P100	Placa pomo fijo	248x45	17.56	2	40
EQ-P100MV	Placa pomo móvil	248x45	18.48	2	40

LAT

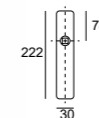

Ref.	Opciones	mm	CU	NM	PB		
EQ-330	Jgo. Manivela	222x30	24.72	24.72	24.72	1	20

LAT

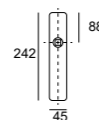

Ref.	Opciones	mm	CU	PS		
EQ-297	Jgo. Manivela	242x45	22.60	22.60	1	20
EQ-M297	Manillón	242x45	15.60	15.60	2	40
EQ-L297	Placa limpieza	242x45	7.54	7.54	10	100
EQ-C297	Asa corta c/placa	242x45	15.60	15.60	2	40
EQ-T400	Tirador armario	123x35	4.87	4.87	20	200
EQ-A400	Tirador maletero	83x35	3.25	3.25	20	200
EQ-P297	Placa pomo fijo	242x45	17.56	17.56	2	40
EQ-P297MV	Placa pomo móvil	242x45	18.27	18.27	2	40

LAT

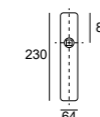

Ref.	Opciones	mm	CU	PS		
EQ-525	Jgo. Manivela	230x64	37.60	37.60	1	20
EQ-M525	Manillón	230x64	16.47	16.47	2	40
EQ-L525	Placa limpieza	230x64	9.49	9.49	10	100
EQ-C525	Asa corta c/placa	230x64	16.47	16.47	2	40
EQ-P525	Placa pomo fijo	230x64	21.85	21.85	2	40
EQ-P525MV	Placa pomo móvil	230x60	22.56	22.56	2	40

LAT

- AN Anticato
- ANTR Antracita
- BL Blanco
- CB Cromo Brillo
- CC Cromo Combinado
- CI Cuero Inglés
- CS Cromo Satinado
- CU Cuero
- LM Latón Mate
- MR Marrón
- NE Negro
- NM Níquel Mate
- NMM Níquel Mate Mate
- NM.OP Níq. Mat. Opaco
- NS Níquel Satinado
- PB Pulido Brillo
- PS Pulido Satín.
- PL Plata
- PVL M PVD Lat. Mate

JANDEL ORIGINAL

JANDEL ORIGINAL

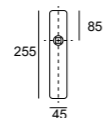

Ref.	Opciones	mm	CU	PS		
EQ-796	Jgo. Manivela	255x45	22.29	22.29	1	20
EQ-M796	Manillón	255x45	15.60	15.60	2	40
EQ-L796	Placa limpieza	255x45	6.83	6.83	10	100
EQ-C796	Asa corta c/placa	255x45	15.60	15.60	2	40
EQ-T599	Tirador armario	129x33	3.58	4.87	20	200
EQ-A599	Tirador maletero	89x33	3.58	3.58	20	200
EQ-P796	Placa pomo fijo	255x45	16.85	16.85	2	40
EQ-P796MV	Placa pomo móvil	255x45	17.56	17.56	2	40

LAT

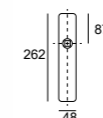

Ref.	Opciones	mm	CU	PS		
EQ-2733	Jgo. Manivela	262x48	31.76	31.76	1	20
EQ-M733	Manillón	262x48	15.05	15.05	2	40
EQ-L733	Placa limpieza	262x48	7.83	7.83	10	100
EQ-C733	Asa corta c/placa	262x48	15.05	15.05	2	40
EQ-T400	Tirador armario	128x33	4.87	4.87	20	200
EQ-A400	Tirador maletero	88x33	3.25	3.25	20	200
EQ-P733	Placa pomo fijo	262x48	20.43	20.43	2	40
EQ-P733MV	Placa pomo móvil	262x48	21.14	21.14	2	40

LAT

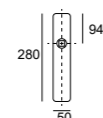

Ref.	Opciones	mm	CU	PS		
EQ-1599	Jgo. Manivela	280x50	27.25	27.25	1	20
EQ-M599	Manillón	280x50	15.60	15.60	2	40
EQ-L599	Placa limpieza	280x50	8.60	8.60	10	100
EQ-C599	Asa corta c/placa	280x50	15.60	15.60	2	40
EQ-T599	Tirador armario	128x33	3.58	4.87	20	200
EQ-A599	Tirador maletero	88x33	3.58	3.58	20	200
EQ-P599	Placa pomo fijo	280x50	21.85	21.85	2	40
EQ-P599MV	Placa pomo móvil	280x50	22.56	22.56	2	40

LAT

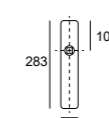

Ref.	Opciones	mm	NM	PS		
EQ-3800	Jgo. Manivela	283X56	43.05	43.05	1	20
EQ-M380	Manillón	283X56	15.85	16.85	2	40
EQ-L800	Placa limpieza	283X56	10.23	10.23	10	100
EQ-C800	Asa corta c/placa	283X56	16.85	16.85	2	40
EQ-T400	Tirador armario	128x33	4.87	4.87	20	200
EQ-A400	Tirador maletero	88x33	3.58	3.25	20	200
EQ-P800	Placa pomo fijo	283X56	22.56	22.56	2	40
EQ-P800MV	Placa pomo móvil	283x56	23.29	23.29	2	40

LAT

- AN Anticato
- ANTR Antracita
- BL Blanco
- CB Cromo Brillo
- CC Cromo Combinado
- CI Cuero Inglés
- CS Cromo Satinado
- CU Cuero
- LM Latón Mate
- MR Marrón
- NE Negro
- NM Níquel Mate
- NMM Níquel Mate Mate
- NM.OP Níq. Mat. Opaco
- NS Níquel Satinado
- PB Pulido Brillo
- PS Pulido Satin.
- PL Plata
- PVL M PVD Lat. Mate

JANDEL ORIGINAL

JANDEL ORIGINAL

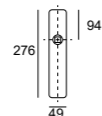

Ref.	Opciones	mm	CU	PS		
EQ-4402	Jgo. Manivela	276x49	40.78	40.78	1	20
EQ-M402	Manillón	276x49	16.47	16.47	2	40
EQ-L402	Placa limpieza	276x49	9.87	9.87	10	100
EQ-C402	Asa corta c/placa	276x49	16.47	16.47	2	40
EQ-T599	Tirador armario	128x33	3.58	4.87	20	200
EQ-A599	Tirador maletero	88x33	3.58	3.58	20	200
EQ-P402	Placa pomo fijo	276x49	22.56	22.56	2	40
EQ-P402MV	Placa pomo móvil	276x49	23.29	23.29	2	40

LAT

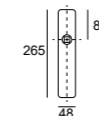

Ref.	Opciones	mm	CU	NM	PS		
EQ-4419	Jgo. Manivela	265x48	30.67	30.67	30.67	1	20
EQ-M419	Manillón	265x48	14.32	14.32	14.32	2	40
EQ-L419	Placa limpieza	265x48	7.74	7.74	7.74	10	100
EQ-C419	Asa corta c/placa	265x48	14.32	14.32	14.32	2	40
EQ-T400	Tirador armario	128x33	4.87	4.87	4.87	20	200
EQ-A400	Tirador maletero	88x33	3.25	3.58	3.25	20	200
EQ-P419	Placa pomo fijo	265x48	19.72	19.72	19.72	2	40
EQ-P419MV	Placa pomo móvil	265x48	20.43	20.43	20.43	2	40

LAT

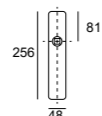

Ref.	Opciones	mm	CU	PS		
EQ-4406	Jgo. Manivela	256x48	30.74	30.74	1	20
EQ-M406	Manillón	256x48	16.14	16.14	2	40
EQ-L406	Placa limpieza	256x48	7.74	7.74	10	100
EQ-C406	Asa corta c/placa	256x48	16.14	16.14	2	40
EQ-T400	Tirador armario	128x33	4.87	4.87	20	200
EQ-A400	Tirador maletero	88x33	3.25	3.25	20	200
EQ-P406	Placa pomo fijo	256x48	20.76	20.76	2	40
EQ-P406MV	Placa pomo móvil	256x48	21.47	21.47	2	40

LAT



- AN Anticato
- ANTR Antracita
- BL Blanco
- CB Cromo Brillo
- CC Cromo Combinado
- CI Cuero Inglés
- CS Cromo Satinado
- CU Cuero
- LM Latón Mate
- MR Marrón
- NE Negro
- NM Níquel Mate
- NMM Níquel Mate Mate
- NM.OP Níq. Mat. Opaco
- NS Níquel Satinado
- PB Pulido Brillo
- PS Pulido Satin.
- PL Plata
- PVL M PVD Lat. Mate

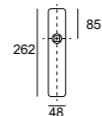

Ref.	Opciones	mm	CU	PS		
EQ-4423	Jgo. Manivela	262x48	36.96	36.96	1	20
EQ-M423	Manillón	262x48	15.40	15.40	2	40
EQ-L423	Placa limpieza	262x48	7.74	7.74	10	100
EQ-C423	Asa corta c/placa	262x48	15.40	15.40	2	40
EQ-T424	Tirador armario	131x35	3.58	3.58	20	200
EQ-A424	Tirador maletero	85x35	3.25	3.25	20	200
EQ-P423	Placa pomo fijo	262x48	20.43	20.43	2	40
EQ-P423MV	Placa pomo móvil	262x48	21.14	21.14	2	40

LAT

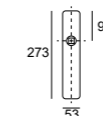

Ref.	Opciones	mm	CU	PS		
EQ-4450	Jgo. Manivela	273X53	35.12	35.12	1	20
EQ-M450	Manillón	273X53	15.40	15.40	2	40
EQ-L450	Placa limpieza	273X53	8.07	8.07	10	100
EQ-C450	Asa corta c/placa	273X53	15.40	15.40	2	40
EQ-T400	Tirador armario	128x33	4.87	4.87	20	200
EQ-A400	Tirador maletero	88x33	3.25	3.25	20	200
EQ-P450	Placa pomo fijo	273X53	18.98	18.98	2	40
EQ-P450MV	Placa pomo móvil	273x53	19.72	19.72	2	40

LAT

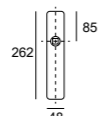

Ref.	Opciones	mm	CU	PS		
EQ-4424	Jgo. Manivela	262x48	32.20	32.20	1	20
EQ-M424	Manillón	262x48	15.40	15.40	2	40
EQ-L424	Placa limpieza	262x48	8.07	8.07	10	100
EQ-C424	Asa corta c/placa	262x48	15.40	15.40	2	40
EQ-T424	Tirador armario	131x35	3.58	3.58	20	200
EQ-A424	Tirador maletero	85x35	3.25	3.25	20	200
EQ-P424	Placa pomo fijo	262x48	20.43	20.43	2	40
EQ-P424MV	Placa pomo móvil	262x48	21.14	21.14	2	40

LAT

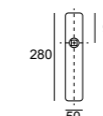

Ref.	Opciones	mm	CU	PS		
EQ-8300	Jgo. Manivela	280x50	34.29	34.29	1	20
EQ-M300	Manillón	280x50	15.94	15.94	2	40
EQ-L300	Placa limpieza	280x50	8.60	8.60	10	100
EQ-C300	Asa corta c/placa	280x50	15.94	15.94	2	40
EQ-T400	Tirador armario	128x33	4.87	4.87	20	200
EQ-A400	Tirador maletero	88x33	3.25	3.25	20	200
EQ-P300	Placa pomo fijo	280x50	20.76	20.76	2	40
EQ-P300MV	Placa pomo móvil	280x50	21.47	21.47	2	40

LAT

- AN Anticato
- ANTR Antracita
- BL Blanco
- CB Cromo Brillo
- CC Cromo Combinado
- CI Cuero Inglés
- CS Cromo Satinado
- CU Cuero
- LM Latón Mate
- MR Marrón
- NE Negro
- NM Níquel Mate
- NMM Níquel Mate Mate
- NM.OP Níq. Mat. Opaco
- NS Níquel Satinado
- PB Pulido Brillo
- PS Pulido Satin.
- PL Plata
- PVLMPVD Lat. Mate

JANDEL ORIGINAL

JANDEL ORIGINAL

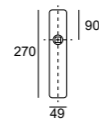
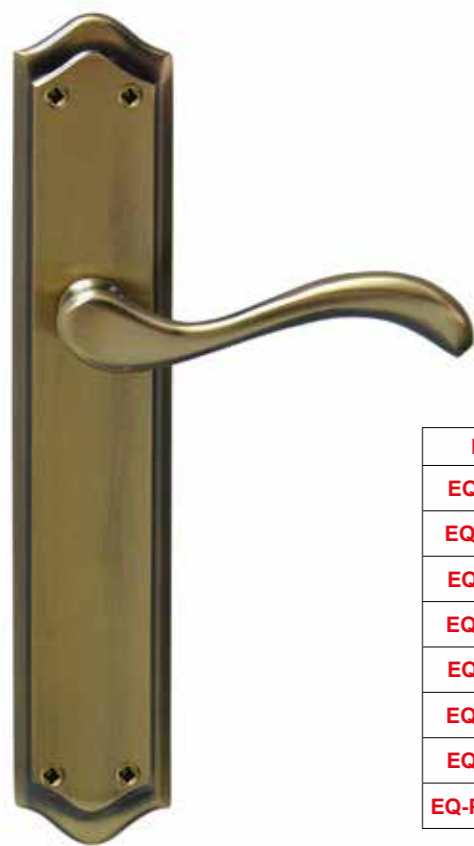

Ref.	Opciones	mm	CU	PS		
EQ-9500	Jgo. Manivela	270x49	31.45	31.45	1	20
EQ-M500	Manillón	270x49	16.14	16.14	2	40
EQ-L500	Placa limpieza	270x49	8.07	8.07	10	100
EQ-C500	Asa corta c/placa	270x49	16.14	16.14	2	40
EQ-T400	Tirador armario	128x33	4.87	4.87	20	200
EQ-A400	Tirador maletero	88x33	3.25	3.25	20	200
EQ-P500	Placa pomo fijo	270x49	20.43	20.43	2	40
EQ-P500MV	Placa pomo móvil	270x49	21.14	21.14	2	40

LAT

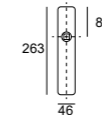
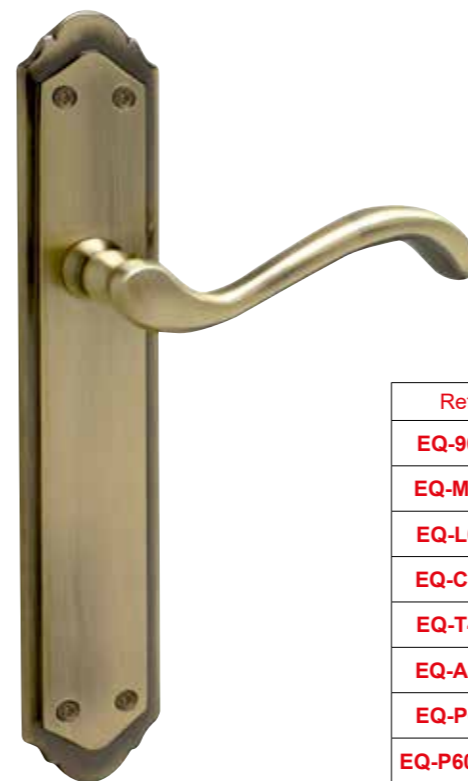

Ref.	Opciones	mm	CI	CU	PS		
EQ-9600	Jgo. Manivela	263x46	30.27	30.27	30.27	1	20
EQ-M600	Manillón	263x46	16.14	16.14	16.14	2	40
EQ-L600	Placa limpieza	263x46	8.25	8.25	8.25	10	100
EQ-C600	Asa corta c/placa	263x46	16.14	16.14	16.14	2	40
EQ-T400	Tirador armario	128x33	4.67	4.87	4.87	20	200
EQ-A400	Tirador maletero	88x33	3.58	3.25	3.25	20	200
EQ-P600	Placa pomo fijo	263x46	21.85	21.85	21.85	2	40
EQ-P600MV	Placa pomo móvil	263x46	22.56	22.56	22.56	2	40

LAT

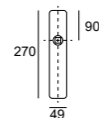

Ref.	Opciones	mm	CU	PS		
EQ-9501	Jgo. Manivela	270x49	25.27	24.29	1	20
EQ-M500	Manillón	270x49	16.14	16.14	2	40
EQ-L500	Placa limpieza	270x49	8.07	8.07	10	100
EQ-C500	Asa corta c/placa	270x49	16.14	16.14	2	40
EQ-T400	Tirador armario	128x33	4.87	4.87	20	200
EQ-A400	Tirador maletero	88x33	3.25	3.25	20	200
EQ-P500	Placa pomo fijo	270x49	20.43	20.43	2	40
EQ-P500MV	Placa pomo móvil	270x49	21.14	21.14	2	40

LAT



- AN Anticato
- ANTR Antracita
- BL Blanco
- CB Cromo Brillo
- CC Cromo Combinado
- CI Cuero Inglés
- CS Cromo Satinado
- CU Cuero
- LM Latón Mate
- MR Marrón
- NE Negro
- NM Níquel Mate
- NMM Níquel Mate Mate
- NM.OP Níq. Mat. Opaco
- NS Níquel Satinado
- PB Pulido Brillo
- PS Pulido Satin.
- PL Plata
- PVL M PVD Lat. Mate

JANDEL ORIGINAL



Estas referencias se pueden montar con todas las manivelas y en todos los acabados de nuestra serie **Jandel Original**

PLACAS LAT

- 35 Placa manivela
- 45 Placa manivela
- 15 Placa manivela
- 00 Placa manivela Sin muelle



ROSETAS ZK

CXC 64 x 30 mm Roseta rect. Con muelle



CX 64 x 30 mm Roseta oval Con muelle



GRISÁN ZK

GC 64 x 30 mm Placa grisán DK rectangular



G 64 x 30 mm Placa grisán DK oval



Ref.	AN	ANTR	BL	CB	CI	CS	CU	LM	MR	NE	NM	NMM	PB	PL	PVLM
35	21.89	-	-	22.76	21.89	22.76	21.89	21.89	21.89	24.52	25.38	-	21.02	-	-
45	12.23	12.23	12.23	12.68	12.23	12.68	12.23	12.23	12.23	13.12	13.12	12.23	12.23	-	32.20
15	9.67	9.67	9.67	10.50	9.67	10.50	9.67	9.67	9.67	11.40	11.40	9.67	8.77	14.36	32.20
00	12.68	-	13.44	13.60	13.12	13.60	12.68	12.68	12.68	14.44	14.44	-	12.48	18.56	-
GC	-	-	11.52	12.32	12.48	12.32	-	10.76	-	11.52	12.80	-	10.31	-	-
G	10.76	-	9.28	10.40	10.56	10.40	10.76	9.92	10.76	12.39	10.88	-	9.92	15.33	-
CXC	-	-	15.68	16.48	16.64	16.48	-	10.40	-	15.68	17.12	-	9.89	-	-
CX	10.40	-	10.24	11.04	11.20	11.04	10.40	10.56	10.40	12.02	11.68	-	10.56	16.32	-

- AN Anticato
- ANTR Antracita
- BL Blanco
- CB Cromo Brillo
- CC Cromo Combinado
- CI Cuero Inglés
- CS Cromo Satinado
- CU Cuero
- LM Latón Mate
- MR Marrón
- NE Negro
- NM Níquel Mate
- NMM Níquel Mate Mate
- NM.OP Níq. Mat. Opaco
- NS Níquel Satinado
- PB Pulido Brillo
- PS Pulido Satin.
- PL Plata
- PVLM PVD Lat. Mate

JANDEL ORIGINAL

Ref.	mm (centr.)	CB	CI	CS	CU	LM	NM	PB	
C302	150 (ROSETA)	50.28	38.92	50.28	38.92	38.92	50.28	37.19	5
C302	150 (PLACA)	52.48	41.57	52.48	41.57	41.57	52.48	39.36	2

Ref.	mm (centr.)	AN	CI	CU	NM	PB	PL	
EQ-M890	220	35.27	35.27	35.27	35.27	35.27	35.27	2

Porcelana craquelé

Ref.	mm (centr.)	AN	CI	CU	NM	PB	PL	
EQ-M891	220	35.27	35.27	35.27	35.27	35.27	35.27	2

Porcelana beige

Ref.	mm (centr.)	AN	CI	CU	NM	PB	PL	
EQ-M892	220	35.27	35.27	35.27	35.27	35.27	35.27	2

Porcelana blanca



C302 LAT

EQ-M890 LAT



EQ-M891 LAT



EQ-M892 LAT



C307 LAT



C308 LAT



C309 LAT



C310 LAT
C312 LAT

Ref.	mm (entre cent.)	CB	CC	CI	CS	LM	NM	PB	
C307	200	101.12	101.12	89.86	101.12	89.86	106.79	89.86	2

Ref.	mm (entre cent.)	CB	CC	CI	CS	LM	NM	PB	
C308	200	114.56	114.56	103.40	114.56	103.40	120.26	103.40	2

Ref.	mm (entre cent.)	CB	CC	CI	CU	CS	LM	NM	PB	
C309	200	95.56	95.56	84.26	84.26	95.56	84.26	101.12	84.26	2

Ref.	mm (entre cent.)	AN	CB	CI	CS	CU	LM	MR	NE	NM	PB	PL	
C310	200	17.18	16.18	16.80	16.18	16.18	16.58	17.18	16.80	16.18	16.58	17.18	5
C312	160	23.17	25.83	23.17	25.83	23.17	23.17	23.17	27.56	27.56	22.31	33.22	10

- AN Anticato
- ANTR Antracita
- BL Blanco
- CB Cromo Brillo
- CC Cromo Combinado
- CI Cuero Inglés
- CS Cromo Satinado
- CU Cuero
- LM Latón Mate
- MR Marrón
- NE Negro
- NM Níquel Mate
- NMM Níquel Mate Mate
- NM.OP Níq. Mat. Opaco
- NS Níquel Satinado
- PB Pulido Brillo
- PS Pulido Satin.
- PL Plata
- PVL M PVD Lat. Mate



C311 LAT



C313 LAT



C316 LAT



C349 ZK



C320 LAT

Ref.	mm (entre cent.)	AN	CB	CI	CS	CU	LM	MR	NM	PB	
C311	200	26.24	34.53	26.24	34.53	26.24	26.24	26.24	36.16	25.73	10

Ref.	mm (entre cent.)	CB	CI	CS	CU	LM	NM	PB	
C313	200	49.54	49.54	49.54	49.54	49.54	49.54	42.82	5

Ref.	mm (entre cent.)	CB	CC	CS	NM	
C316	200	96.23	96.23	96.23	103.65	2

Ref.	mm (entre cent.)	CB	CC	CS	NM	
C320	200	92.84	92.84	92.84	92.84	1
	250	109.28	109.28	109.28	109.28	1
	300	125.67	125.67	125.67	131.11	1
	400	158.40	158.40	158.40	163.88	1
	500	191.17	191.17	191.17	196.64	1

Ref.	mm (entre cent.)	ANTR	BL	CB	CS	NE	NMM	
C349	200	20.16	20.16	20.16	19.56	20.16	19.56	1

- AN Anticato
- ANTR Antracita
- BL Blanco
- CB Cromo Brillo
- CC Cromo Combinado
- CI Cuero Inglés
- CS Cromo Satinado
- CU Cuero
- LM Latón Mate
- MR Marrón
- NE Negro
- NM Níquel Mate
- NMM Níquel Mate Mate
- NM.OP Níq. Mat. Opaco
- NS Níquel Satinado
- PB Pulido Brillo
- PS Pulido Satin.
- PL Plata
- PVL M PVD Lat. Mate

JANDEL ORIGINAL

JANDEL ORIGINAL



C327 ZK

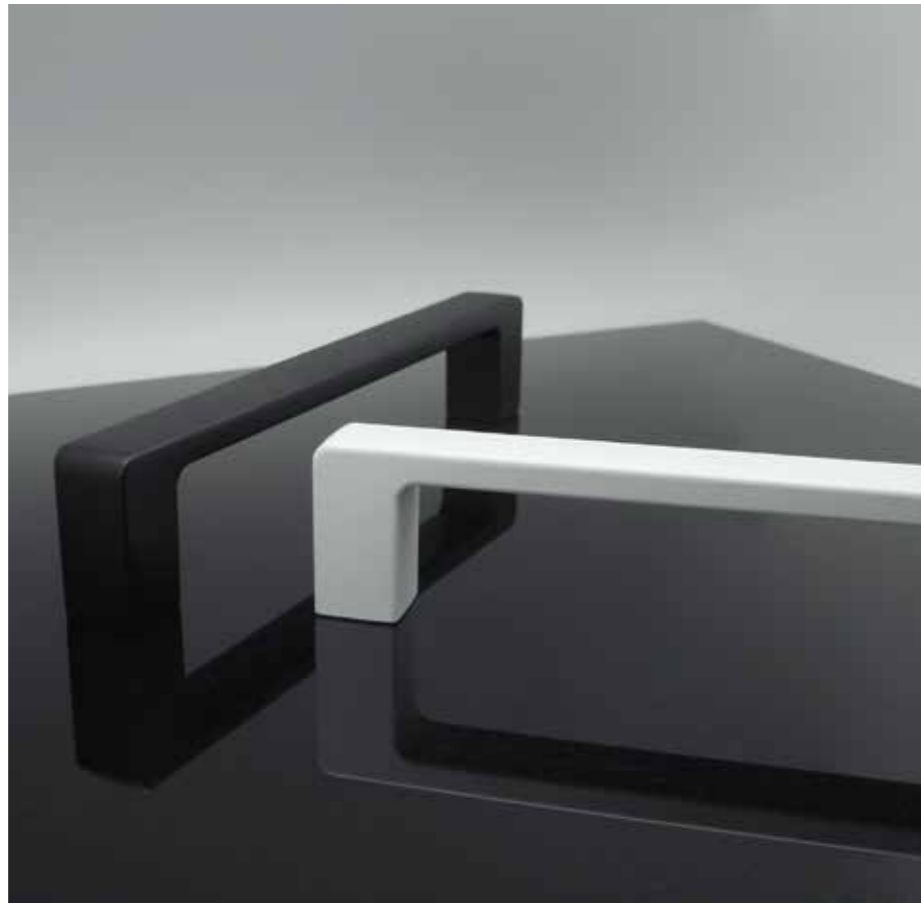

Ref.	mm (entre cent.)	ANTR	BL	CB	CI	CS	LM	NE	NMM	NS	PB	PVLM	
C327	210	21.75	21.75	20.68	20.68	20.68	20.68	22.03	21.24	20.68	20.68	65.58	2

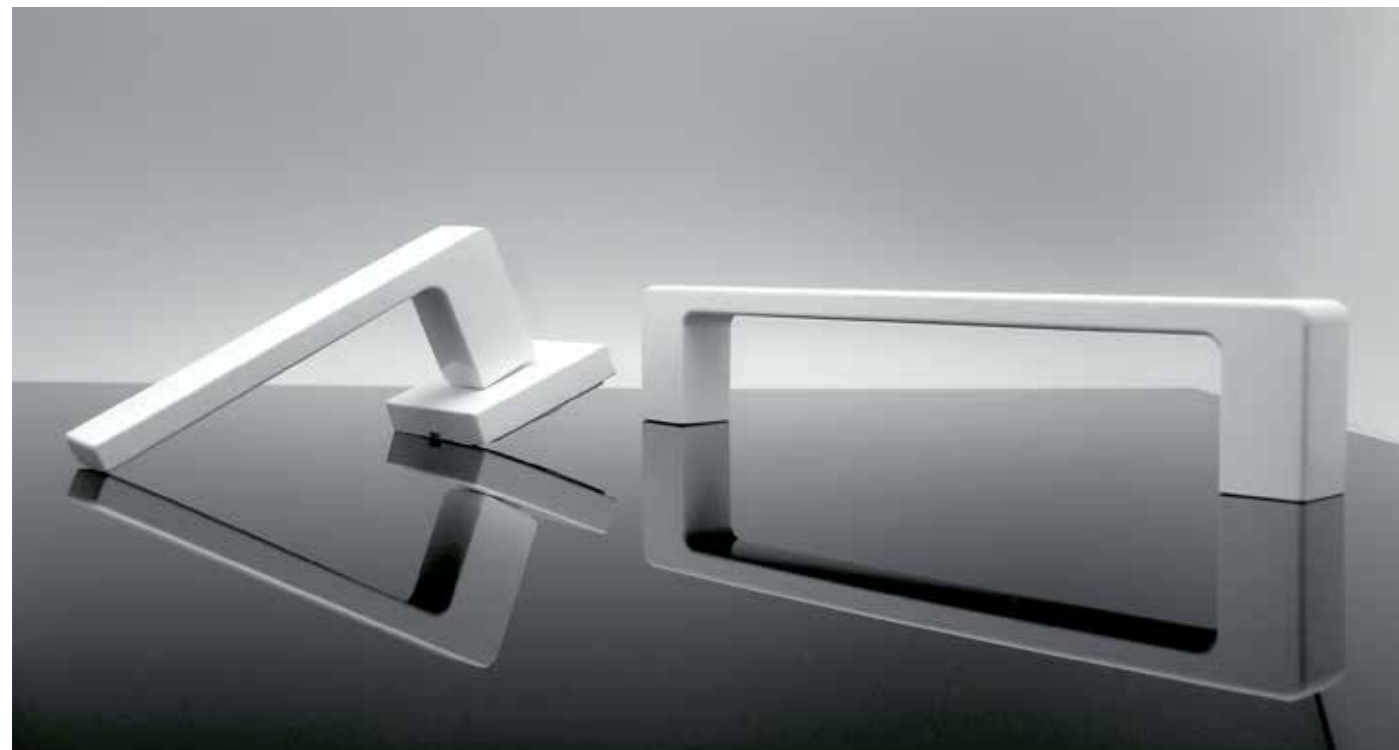

C322 LAT



C326 LAT

Ref.	mm (entre cent.)	CI	CS	CU	LM	NM	PB	
C322	210	91.17	96.10	91.17	91.17	96.61	86.21	2

Ref.	mm (entre cent.)	CI	CU	LM	MR	NM	PB	PL	
C326	225	87.59	87.59	87.59	87.59	107.52	87.59	112.45	2

- AN Anticato
- ANTR Antracita
- BL Blanco
- CB Cromo Brillo
- CC Cromo Combinado
- CI Cuero Inglés
- CS Cromo Satinado
- CU Cuero
- LM Latón Mate
- MR Marrón
- NE Negro
- NM Níquel Mate
- NMM Níquel Mate Mate
- NM.OP Níq. Mat. Opaco
- NS Níquel Satinado
- PB Pulido Brillo
- PS Pulido Satin.
- PL Plata
- PVLM PVD Lat. Mate

JANDEL ORIGINAL

JANDEL ORIGINAL



C359 ZK

C800 LAT

Ref.	mm (entre cent.)	AN	CI	NE	PL	
C359	220	20.40	19.23	19.69	20.40	2

Ref.	mm (entre cent.)	CI	NM	PS	
C800	280x50	48.13	56.84	48.13	2

- AN Anticato
- CB Cromo Brillo
- CS Cromo Satinado
- MR Marrón
- NMM Níquel Mate Mate
- PB Pulido Brillo
- PVLN PVD Lat. Mate
- ANTR Antracita
- CC Cromo Combinado
- CU Cuero
- NE Negro
- NM.OP Níq. Mat. Opaco
- PS Pulido Satin.
- BL Blanco
- CI Cuero Inglés
- LM Latón Mate
- NM Níquel Mate
- NS Níquel Satinado
- PL Plata

JANDEL ORIGINAL



Ref.	CI	CU	LM	MR	NM	PB	PL	
CG75 LAT	33.22	33.22	33.22	33.22	36.68	33.22	46.08	2



Ref.	CB	CS	NE	NM	
G13C ZK	34.47	31.04	30.63	31.04	2

JANDEL ORIGINAL



Ref.	CI	LM	NM	PB	
CGKA ZK	19.81	19.81	21.64	18.98	2





Ref.	mm	PVD	
SV-105P	Ø85 (base)	15.93	1

ZK



Ref.	mm	BL	LM	NE	NM	PB	
EQ-1085	Ø85 (base)	11.65	11.65	11.65	11.65	11.65	1

LAT



Ref.	mm	CI	CU	LM	NM	PS	
C207	Ø90 (base)	21.27	21.27	21.27	21.27	21.27	1

LAT



Ref.	mm	CS	CU	NM	PB	
EQ-1095	Ø85 (base)	11.65	11.65	11.65	11.65	1

LAT



Ref.	mm	CI	CU	PS	
C208	Ø85 (base)	16.12	16.12	16.12	1

LAT

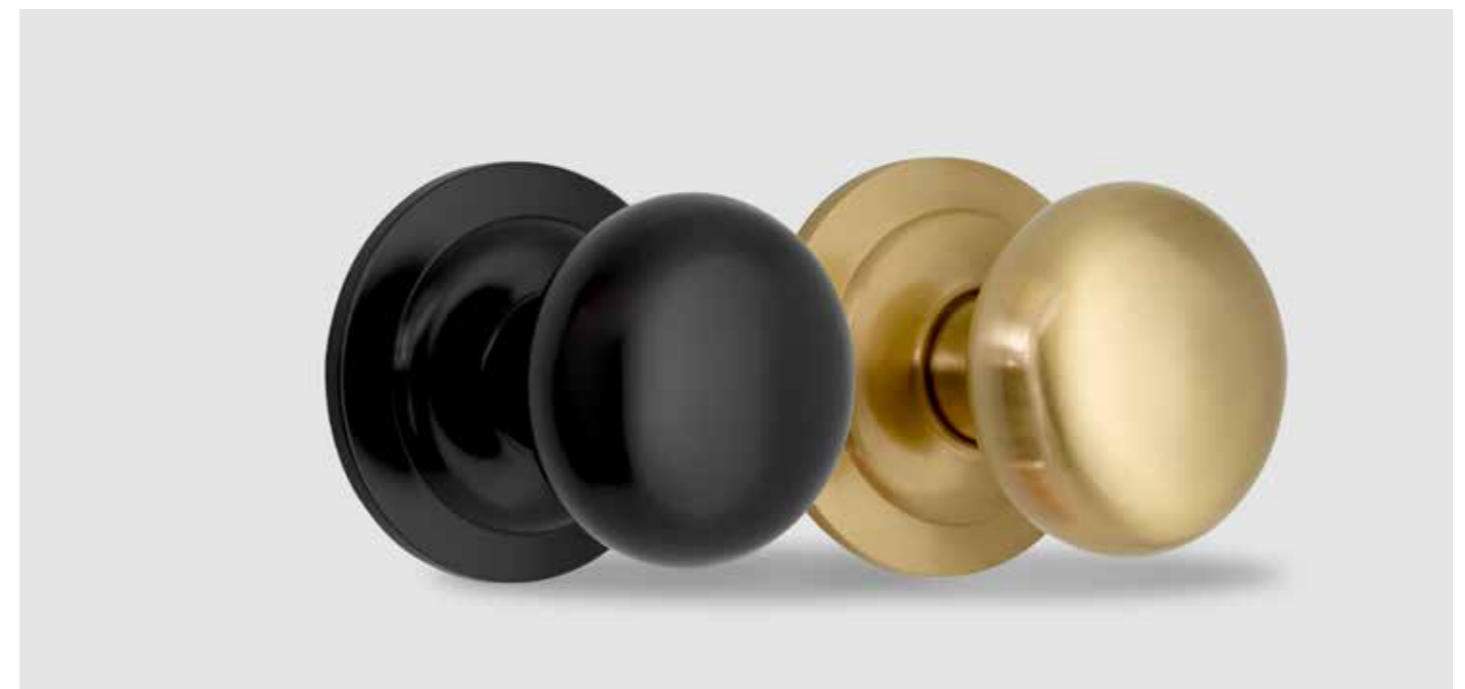

- AN Anticato
- ANTR Antracita
- BL Blanco
- CB Cromo Brillo
- CC Cromo Combinado
- CI Cuero Inglés
- CS Cromo Satinado
- CU Cuero
- LM Latón Mate
- MR Marrón
- NE Negro
- NM Níquel Mate
- NMM Níquel Mate Mate
- NM.OP Níq. Mat. Opaco
- NS Níquel Satinado
- PB Pulido Brillo
- PS Pulido Satin.
- PL Plata
- PVL M PVD Lat. Mate



JANDEL ORIGINAL

JANDEL ORIGINAL

Ref.	mm	CB	CS	LM	NE	NM	PB	
C210	Ø67 (Ø38 base)	70.40	70.40	70.40	70.40	70.40	70.40	1

LAT

Ref.	mm	CB	CI	CS	LM	NE	NM	PB	
C209	67x67 50x50 (base)	50.28	49.41	50.28	47.59	52.55	52.55	47.59	1

LAT





Ref.	mm	AN	CC	CI	CS	CU	LM	MR	PL	
C605	Ø50	8.32	14.88	8.32	14.88	8.32	8.32	8.32	17.51	10

LAT



Ref.	mm	AN	CC	CI	CS	CU	LM	MR	PL	
C606	Ø50	8.32	14.88	8.32	14.88	8.32	8.32	8.32	17.51	10

LAT



Ref.	mm	AN	CB	CI	CS	CU	LM	NS	PB	PL	
SV-BR25	Ø50	4.10	3.43	3.43	3.43	3.43	3.43	2.48	3.43	4.10	10

ZK



Ref.	mm	AN	CB	CI	CS	CU	LM	NM	PB	PL	
EQ-285Z	Ø50	4.10	3.43	3.43	3.43	3.43	3.43	2.48	3.43	4.10	

ZK



Ref.	mm	AN	CC	CI	CS	CU	LM	MR	PL	
C608	Ø50	27.36	36.45	27.36	27.36	36.45	27.36	27.36	48.87	5

LAT



Ref.	mm	AN	BL	CB	CI	CS	CU	LM	NE	NS	PB	PL	
SV-CR50	Ø50	10.13	8.50	8.50	8.50	8.50	8.50	8.50	8.50	6.80	8.50	10.13	2

ZK



Bocallave redonda de seguridad

Ref.	mm	AN	ANTR	BL	CB	CI	CS	CU	LM	MR	NE	NM	NMM	PB	PL	
C630	Ø50	6.96	6.96	8.29	8.29	8.29	8.29	8.29	8.29	19.52	8.29	8.29	6.96	8.29	6.96	10

LAT



Ref.	mm	ANTR	BL	CB	CI	CS	LM	NE	NM	NMM	PVLM	
12BY	Ø50	4.36	4.23	4.23	4.23	4.23	4.23	4.23	4.23	4.23	17.92	10

ZK

- AN Anticato
- ANTR Antracita
- BL Blanco
- CB Cromo Brillo
- CC Cromo Combinado
- CI Cuero Inglés
- CS Cromo Satinado
- CU Cuero
- LM Latón Mate
- MR Marrón
- NE Negro
- NM Níquel Mate
- NMM Níquel Mate Mate
- NM.OP Níq. Mat. Opaco
- NS Níquel Satinado
- PB Pulido Brillo
- PS Pulido Satin.
- PL Plata
- PVLM PVD Lat. Mate

JANDEL ORIGINAL

JANDEL ORIGINAL



Ref.	mm	AN	ANTR	BL	CB	CI	CS	CU	LM	NE	NMM	NS	PB	PL	PVLM	
SV-495	Ø35	6.80	6.80	6.38	6.38	6.38	6.38	6.38	6.38	6.38	6.38	4.60	6.38	6.80	32.38	5

ZK



Ref.	mm	CB	CI	CS	LM	NM	PB	
C611	50X50	6.56	8.32	6.56	8.32	6.56	8.32	10

LAT



Ref.	mm	ANTR	BL	CB	CI	CS	LM	NE	NM	NMM	PVLM	
34BY	50X50	4.89	4.76	4.76	4.76	4.76	4.76	4.76	4.76	4.76	17.92	10

ZK



Bocallave cuadrada de seguridad

Ref.	mm	ANTR	BL	CB	CI	CS	LM	NE	NM	NMM	PB	
C635	50X50	7.43	8.29	8.29	7.43	8.29	7.43	8.29	8.29	7.43	7.43	10

LAT



Ref.	BL	CB	CI	CS	CU	LM	NE	NM	PB	
C902	2.78	2.78	2.78	2.78	2.78	2.78	2.78	2.78	2.78	20

ZK

- AN Anticato
- ANTR Antracita
- BL Blanco
- CB Cromo Brillo
- CC Cromo Combinado
- CI Cuero Inglés
- CS Cromo Satinado
- CU Cuero
- LM Latón Mate
- MR Marrón
- NE Negro
- NM Níquel Mate
- NMM Níquel Mate Mate
- NM.OP Níq. Mat. Opaco
- NS Níquel Satinado
- PB Pulido Brillo
- PS Pulido Satin.
- PL Plata
- PVLM PVD Lat. Mate

JANDEL ORIGINAL

JANDEL ORIGINAL



Ref.	mm	ANTR	BL	CB	CI	CS	LM	NE	NM	NMM	
12WC	Ø50	10.03	9.58	9.58	9.58	9.58	9.58	9.58	9.58	9.58	5

ZK

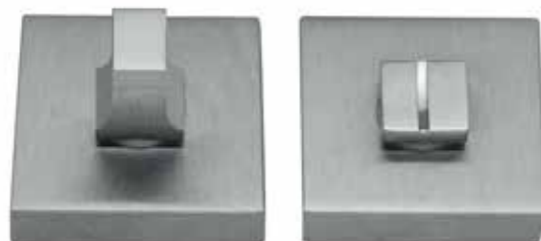

Ref.	mm	CB	CC	CI	CS	LM	NM	PB	
C621	Ø50	38.47	38.47	41.57	37.64	45.48	39.36	40.55	5

ZK



Ref.	mm	BL	CB	CI	CS	LM	NE	NM	NMM	
34WC	Ø50	11.18	11.18	11.18	11.18	11.18	11.18	11.18	11.18	5

ZK



Ref.	mm	ANTR	BL	CB	CI	CS	LM	NE	NMM	NS	
SVCC35	Ø35	7.95	7.45	7.45	6.80	7.45	7.45	7.45	7.45	6.35	5

ZK



Ref.	mm	AN	ANTR	CB	CI	CS	CU	LM	MR	NM	NMOP	PB	PL	
7610	Ø56 Ø48 (interior)	24.96	19.59	21.45	21.73	21.45	24.96	23.57	24.96	22.47	22.18	22.24	42.85	5

ZK



Ref.	mm	ANTR	CB	CI	CS	LM	NM	NMOP	PB	
7630	Ø56 Ø48 (interior)	20.90	26.12	24.71	26.12	27.11	34.08	24.04	26.43	5

ZK



Ref.	mm	AN	ANTR	BL	CB	CI	CS	CU	EFLM	LM	MR	NE	NM	NM.OP	PB	PL	
7510	Ø56 Ø48 (interior)	44.23	39.91	32.52	43.38	44.23	49.44	38.74	48.07	44.23	44.23	39.68	43.01	39.91	36.15	59.43	1
7530	56x56 Ø48 (interior)	49.49	47.30	38.82	50.79	49.49	47.93	44.36	47.30	47.31	-	50.73	51.73	47.30	44.72	74.76	1

ZK

- AN Anticato
- ANTR Antracita
- BL Blanco
- CB Cromo Brillo
- CC Cromo Combinado
- CI Cuero Inglés
- CS Cromo Satinado
- CU Cuero
- LM Latón Mate
- MR Marrón
- NE Negro
- NM Níquel Mate
- NMM Níquel Mate Mate
- NM.OP Níq. Mat. Opaco
- NS Níquel Satinado
- PB Pulido Brillo
- PS Pulido Satin.
- PL Plata
- PVL M PVD Lat. Mate

JANDEL ORIGINAL

JANDEL ORIGINAL



Ref.	mm	CB	CI	CS	CU	LM	NM	PB	
C410	129x34	14.34	13.48	14.34	13.48	13.48	14.88	12.96	10
C420	79x34	12.39	11.33	12.39	11.33	11.33	12.64	10.76	10

LAT



Ref.	Medidas	CI	NM	PS	
C450	137x33	14.88	20.55	14.88	10
C460	87x33	13.25	18.85	13.25	10

LAT



NEW

Ref.	mm	CI	
EQ-T490 (porc. craquelé)	128x33	12.45	20
EQ-T491 (porc. beige)	128x33	12.45	20
EQ-T492 (porc. blanca)	128x33	12.45	20
EQ-A490 (porc. craquelé)	88x33	11.16	20
EQ-A491 (porc. beige)	88x33	11.16	20
EQ-A492 (porc. blanca)	88x33	11.16	20

LAT

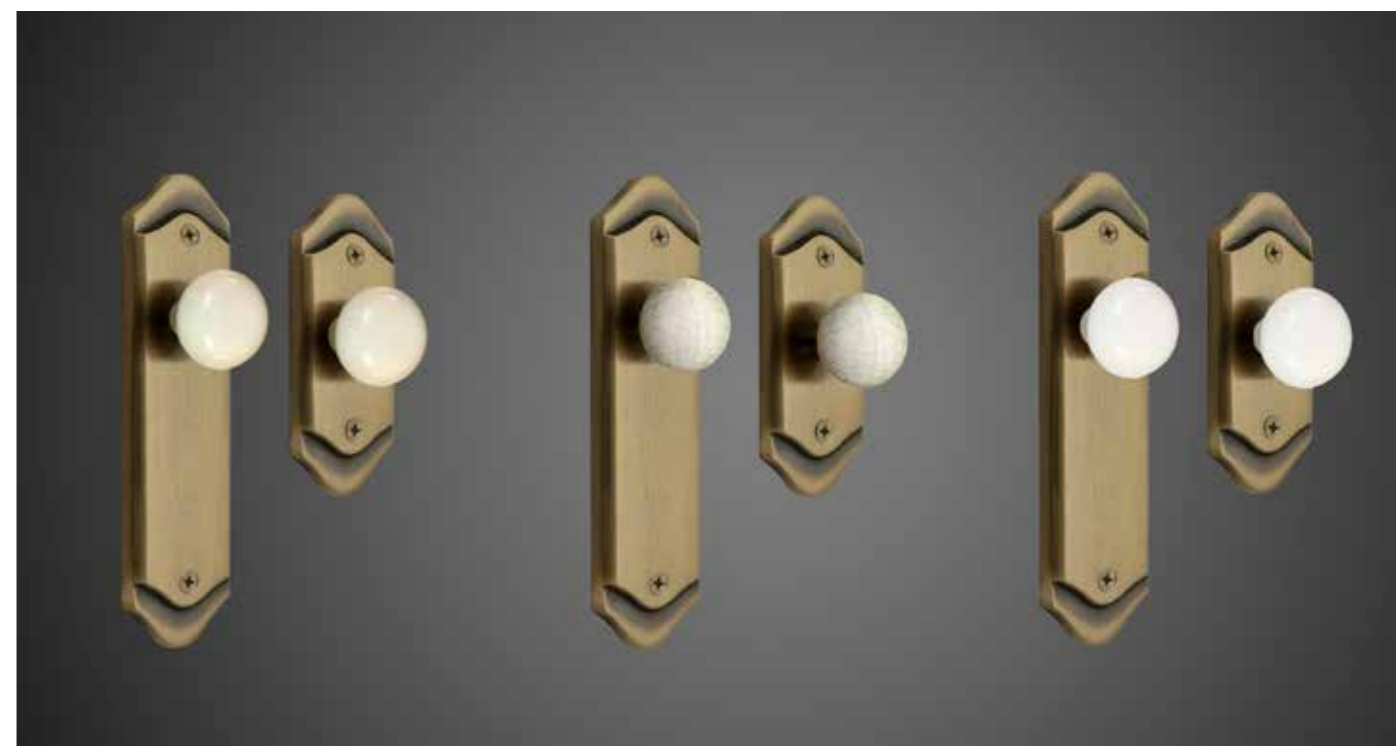

JANDEL ORIGINAL

JANDEL ORIGINAL

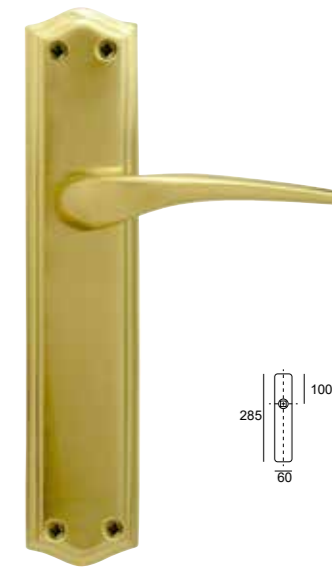
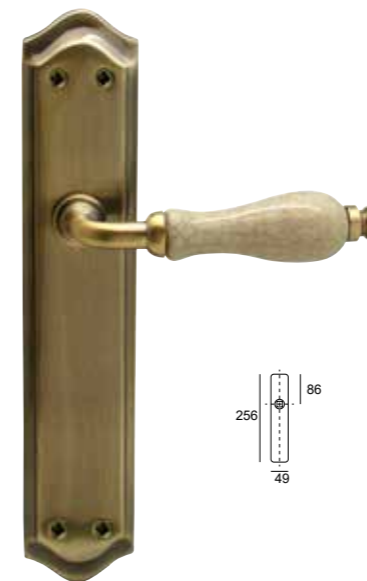
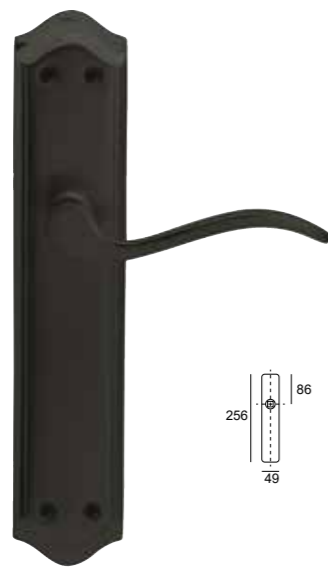

AL

Ref.	Denominación	mm	NE		
EQ-202	Jgo. Manivela	256x49	9.40	2	20
EQ-M202	Manillón	256x49	12.40	4	40
EQ-L202	Placa limpieza	256x49	4.03	10	100
EQ-C202	Asa corta c/placa	256x49	15.58	4	40
EQ-T202	Tirador armario	123x35	3.83	20	200
EQ-A202	Tirador maletero	83x35	2.78	20	200
EQ-P202	Placa pomo fijo	256x49	15.58	2	40
EQ-P202MV	Placa pomo móvil	256x49	16.43	2	40

AL

Ref.	Denominación	mm	PS		
EQ-203	Jgo. Manivela	256x49	8.95	2	20
EQ-M203	Manillón	256x49	12.40	4	40
EQ-L203	Placa limpieza	256x49	4.03	10	100
EQ-C203	Asa corta c/placa	256x49	12.40	4	40
EQ-T203	Tirador armario	123x35	3.83	20	200
EQ-A203	Tirador maletero	83x35	2.78	20	200
EQ-P203	Placa pomo fijo	256x49	15.58	2	40
EQ-P203MV	Placa pomo móvil	256x49	16.43	2	40

AL / LAT

Ref.	Denom.	AN	CI	CU	NS	PL	PS		
EQ-206	Jgo. Man. CRAQUELE	35.25	33.90	33.90	33.90	35.25	33.40	1	20
	Jgo. Man. BEIGE	35.25	33.90	33.90	33.90	35.25	33.40	1	20
	Jgo. Man. BLANCA	35.25	33.90	33.90	33.90	35.25	33.40	1	20
EQ-T290	Tirador armario CRAQUELE	10.05	9.63	9.63	9.63	10.05	9.63	20	200
EQ-T291	Tirador armario BEIGE	9.85	9.45	9.45	9.45	9.85	9.45	20	200
EQ-T292	Tirador armario BLANCA	9.85	9.45	9.45	9.45	9.85	9.45	20	200
EQ-A290	Tirador malet. CRAQUELE	9.63	9.25	9.25	9.25	9.63	9.25	20	200
EQ-A291	Tirador malet. BEIGE	9.45	9.05	9.05	9.05	9.45	9.05	20	200
EQ-A292	Tirador malet. BLANCA	9.45	9.05	9.05	9.05	9.45	9.05	20	200

ZK

Ref.	Denominación	mm	PS		
EQ-207	Jgo. Manivela	285x60	23.02	1	20
EQ-M207	Manillón	285x60	16.68	2	40
EQ-L207	Placa limpieza	285x60	7.08	10	100
EQ-C207	Asa corta c/placa	285x60	16.68	4	40
EQ-T203	Tirador armario	123x35	3.83	20	200
EQ-A203	Tirador maletero	83x35	2.78	20	200
EQ-P207	Placa pomo fijo	285x60	16.68	2	40
EQ-P207MV	Placa pomo móvil	285x60	17.48	2	40

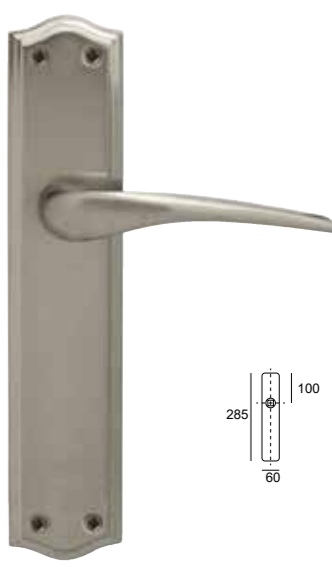
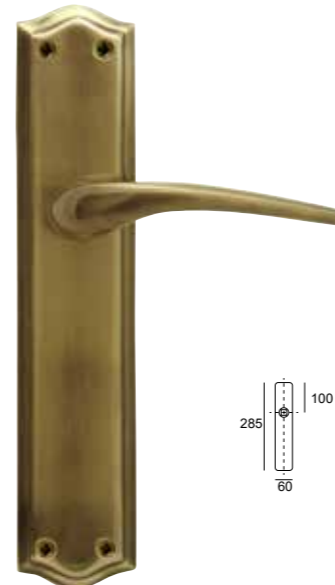
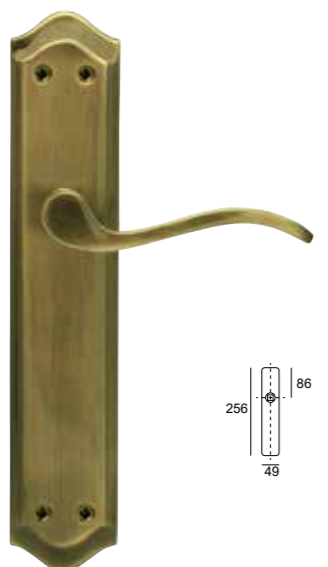

AL

Ref.	Denominación	mm	CU		
EQ-204	Jgo. Manivela	256x49	9.50	2	20
EQ-M204	Manillón	256x49	12.40	4	40
EQ-L204	Placa limpieza	256x49	4.03	10	100
EQ-C204	Asa corta c/placa	256x49	12.40	4	40
EQ-T204	Tirador armario	123x35	3.83	20	200
EQ-A204	Tirador maletero	83x35	2.78	20	200
EQ-P204	Placa pomo fijo	256x49	15.58	2	40
EQ-P204MV	Placa pomo móvil	256x49	16.43	2	40

AL

Ref.	Denominación	mm	NS		
EQ-205	Jgo. Manivela	256x49	9.18	2	20
EQ-M205	Manillón	256x49	12.40	4	40
EQ-L205	Placa limpieza	256x49	4.03	10	100
EQ-C205	Asa corta c/placa	256x49	12.40	4	40
EQ-T205	Tirador armario	123x35	3.83	20	200
EQ-A205	Tirador maletero	83x35	2.78	20	200
EQ-P205	Placa pomo fijo	256x49	15.58	2	40
EQ-P205MV	Placa pomo móvil	256x49	16.43	2	40

ZK

Ref.	Denominación	mm	CU		
EQ-208	Jgo. Manivela	285x60	23.02	1	20
EQ-M208	Manillón	285x60	16.68	2	40
EQ-L208	Placa limpieza	285x60	7.08	10	100
EQ-C208	Asa corta c/placa	285x60	16.68	4	40
EQ-T204	Tirador armario	123x35	3.83	20	200
EQ-A204	Tirador maletero	83x35	2.78	20	200
EQ-P208	Placa pomo fijo	285x60	16.68	2	40
EQ-P208MV	Placa pomo móvil	285x60	17.48	2	40

ZK

Ref.	Denominación	mm	NS		
EQ-209	Jgo. Manivela	285x60	23.02	1	20
EQ-M209	Manillón	285x60	16.68	2	40
EQ-L209	Placa limpieza	285x60	7.08	10	100
EQ-C209	Asa corta c/placa	285x60	16.68	4	40
EQ-T205	Tirador armario	123x35	3.83	20	200
EQ-A205	Tirador maletero	83x35	2.78	20	200
EQ-P209	Placa pomo fijo	285x60	16.68	2	40
EQ-P209MV	Placa pomo móvil	285x60	17.48	2	40

- AN Anticato
- ANTR Antracita
- BL Blanco
- CB Cromo Brillo
- CI Cuero Inglés
- CU Cuero
- CS Cromo Satinado
- LM Latón Mate
- NE Negro
- NMM Niq. Mate Mate
- NS Níquel Satinado
- NS/NB Niq. Sat / Niq. Br.
- PB Pulido Brillo
- PL Plata
- PS Pulido Satin.



JANDEL EQUAL

JANDEL EQUAL

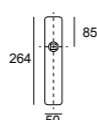
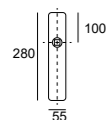

ZK



AL

Ref.	Denominación	mm	CU	NS	PS		
EQ-210	Jgo. Manivela	280x55	24.02	24.02	24.02	1	20
EQ-M210	Manillón	280x55	16.93	16.93	16.93	2	40
EQ-L210	Placa limpieza	280x55	7.08	7.08	7.08	10	100
EQ-C210	Asa corta c/placa	280x55	16.93	16.93	16.93	4	40
EQ-P210	Placa pomo fijo	280x55	16.93	16.93	16.93	2	40
SV-T150	Tirador armario	129x34	4.68	4.68	4.68	20	200
SV-A150	Tirador maletero	79x34	3.85	3.85	3.85	20	200
EQ-P210MV	Placa pomo móvil	280x55	17.48	17.48	17.48	2	40

Ref.	Denominación	mm	CI	NS	PS		
EQ-868	Jgo. Manivela	264x50	11.23	11.23	11.23	2	20
EQ-M868	Manillón	264x50	12.40	12.40	12.40	2	40
EQ-L868	Placa limpieza	264x50	7.08	7.08	7.08	10	100
EQ-C868	Asa corta c/placa	264x50	12.40	12.40	12.40	4	40
EQ-T203	Tirador armario	125x35	3.83	3.83	3.83	20	200
EQ-A203	Tirador maletero	83x35	2.78	2.78	2.78	20	200
EQ-P868	Placa pomo fijo	264x50	17.10	17.10	17.10	2	40
EQ-P868MV	Placa pomo móvil	264x50	17.90	17.90	17.90	2	40





EQ-R150 AL

mm	CU	LM	NE	NS	PB		
Ø 50	9.08	8.55	8.05	6.13	8.55	1	20





EQ-R200 AL

mm	BL	LM	NE	NS	NS/NB		
Ø 50	8.55	8.55	8.05	6.13	9.50	1	20





EQ-R204 AL

mm	CU		
Ø 50	9.50	1	20



SV-R250 AL

mm	NS/NB		
Ø 50	8.55	1	20

- AN Anticato
- ANTR Antracita
- BL Blanco
- CB Cromo Brillo
- CI Cuero Inglés
- CU Cuero
- CS Cromo Satinado
- LM Latón Mate
- NE Negro
- NMM Niq. Mate Mate
- NS Níquel Satinado
- NS/NB Niq. Sat / Niq. Br.
- PB Pulido Brillo
- PL Plata
- PS Pulido Satin.



SV-R300 AL

mm	NS		
Ø 50	8.55	1	20



SV-R333 AL

mm	LM	NE		
Ø 50	12.60	12.60	1	20



NEW

SV-R700 AL

mm	ANTR	NE	NS		
Ø 50	13.45	11.98	10.48	1	20



SV-R800 AL

mm	NS		
Ø 50	11.02	1	20



SV-R350 AL

mm	NS/NB		
Ø 50	8.55	1	20



SV-R600 AL

mm	ANTR	BL	NE	NS	NS/ NB		
Ø 50	12.03	11.90	11.90	10.28	11.90	1	20



NEW

SV-R850 AL

mm	ANTR	LM	NE	NS		
Ø 50	13.15	11.70	11.70	9.98	1	20



NEW

Tapa Pomos

EQ-R655 AL

mm	CU	LM	NE	NS	PB		
Ø 65	13.25	13.25	13.25	13.25	13.25	1	20

- AN Anticato
- ANTR Antracita
- BL Blanco
- CB Cromo Brillo
- CI Cuero Inglés
- CU Cuero
- CS Cromo Satinado
- LM Latón Mate
- NE Negro
- NMM Niq. Mate Mate
- NS Niquel Satinado
- NS/NB Niq. Sat / Niq. Br.
- PB Pulido Brillo
- PL Plata
- PS Pulido Satin.

JANDEL EQUAL

JANDEL EQUAL

NEW



EQ-C150 AL

mm	NS		
50x50	10.70	1	20



SV-C200 AL

mm	NE	NS		
50x50	11.45	10.33	1	20

NEW



SV-C350 AL

mm	NS/NB		
50x50	10.43	1	20



SV-C400 AL

mm	ANTR	BL	LM	NE	NS	NS/NB		
50x50	12.05	12.20	12.20	12.20	10.78	12.20	1	20



SV-C700 AL

mm	NE	NS		
50x50	15.03	13.83	1	20



SV-C750 AL

mm	NS		
50x50	15.08	1	20



- AN Anticato
- ANTR Antracita
- BL Blanco
- CB Cromo Brillo
- CI Cuero Inglés
- CU Cuero
- CS Cromo Satinado
- LM Latón Mate
- NE Negro
- NMM Niq. Mate Mate
- NS Níquel Satinado
- NS/NB Niq. Sat / Niq. Br.
- PB Pulido Brillo
- PL Plata
- PS Pulido Satin.

MANILLAS EN NEGRO



EQ-R150



SV-R700



EQ-R200



SV-R850



SV-R333



SV-C200



SV-R600



SV-C400



SV-R655



SV-C700

MANILLAS EN LATÓN MATE



EQ-R150



EQ-R200



SV-C400



SV-R850



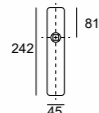
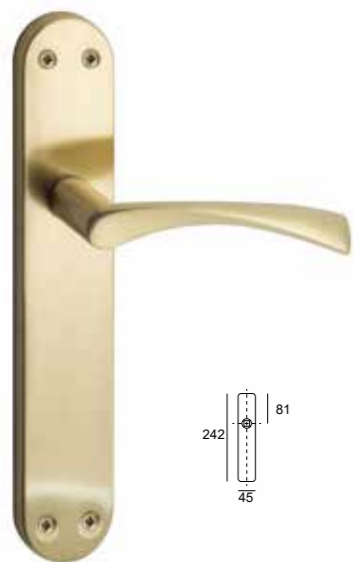

SV-R333

- AN Anticato
- ANTR Antracita
- BL Blanco
- CB Cromo Brillo
- CI Cuero Inglés
- CU Cuero
- CS Cromo Satinado
- LM Latón Mate
- NS Níquel Satinado
- NS/NB Níq. Sat / Níq. Br.
- MMM Níq. Mate Mate
- PL Plata
- PS Pulido Satin.
- PB Pulido Brillo



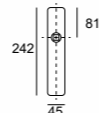

AL

Ref.	CU	LM	NE	NS	PB		
SV-P150	9.88	9.88	9.88	8.80	9.88	2	20



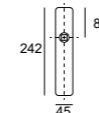

AL

Ref.	BL	LM	NE	NS		
SV-P200	11.95	10.90	10.90	9.10	2	20



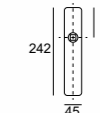

AL

Ref.	NS/NB		
SV-P350	12.95	2	20



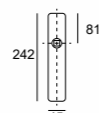

AL

Ref.	ANTR	BL	NE	NS		
SV-P600	17.40	14.68	14.68	12.95	1	20



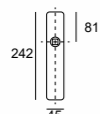

AL

Ref.	NS/NB		
SV-P250	12.95	2	20



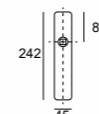
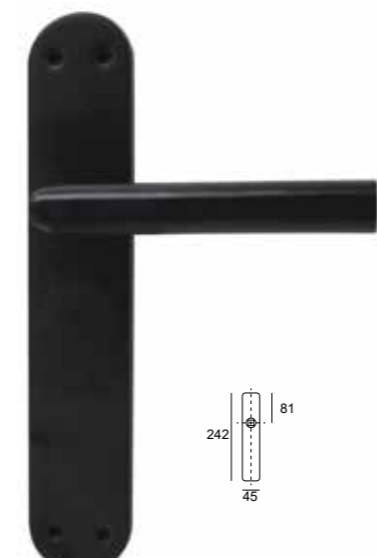

AL

Ref.	NS		
SV-P300	12.95	2	20



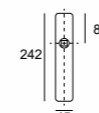

AL

Ref.	LM	NE		
SV-P333	15.38	15.38	1	20



NEW

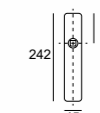
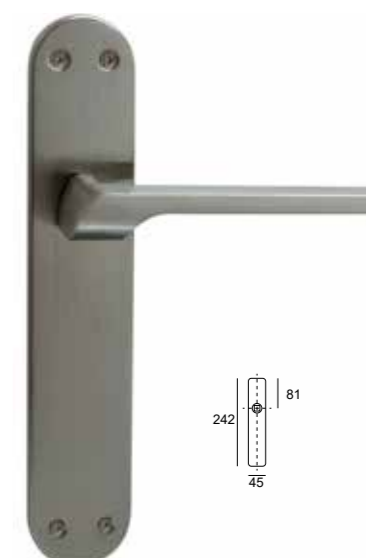

AL

Ref.	ANTR	LM	NE	NS		
SV-P850	17.40	15.30	15.13	12.98	1	20



NEW

AL

Ref.	ANTR	NE	NS		
SV-P700	17.40	14.90	14.03	1	20



- AN Anticato
- ANTR Antracita
- BL Blanco
- CB Cromo Brillo
- CI Cuero Inglés
- CU Cuero
- CS Cromo Satinado
- LM Latón Mate
- NE Negro
- NMM Niq. Mate Mate
- NS Niquel Satinado
- NS/NB Niq. Sat / Niq. Br.
- PB Pulido Brillo
- PL Plata
- PS Pulido Satin.

NEW



AL

Ref.	NE	NS		
SV-PC20	14.30	12.95	1	20



AL

Ref.	NS/NB		
SV-PC35	15.13	1	20

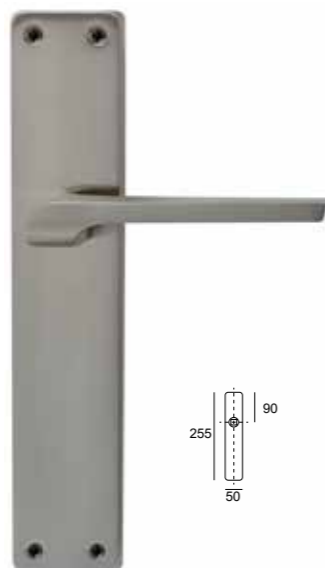

AL

Ref.	NE	NS		
SV-PC70	16.28	15.53	1	20



AL

Ref.	NS		
SV-PC75	15.53	1	20



AL

Ref.	ANTR	BL	LM	NE	NS	NS/NB		
SV-P400	17.93	16.83	16.83	16.83	15.83	16.40	1	20



- AN Anticato
- ANTR Antracita
- BL Blanco
- CB Cromo Brillo
- CI Cuero Inglés
- CU Cuero
- CS Cromo Satinado
- LM Latón Mate
- NE Negro
- MMM Niq. Mate Mate
- NS Níquel Satinado
- NS/NB Niq. Sat / Níq. Br.
- PB Pulido Brillo
- PL Plata
- PS Pulido Satin.

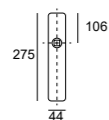

ZK

Ref.	NE		
SV-P398	14.23	1	20

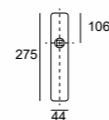

ZK

Ref.	NE		
SV-P500	12.95	1	20

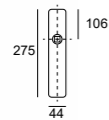

ZK

Ref.	NE		
SV-PP50	13.38	2	40

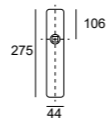

ZK

Ref.	NE		
SV-M500	9.68	5	40



- AN Anticato
- ANTR Antracita
- BL Blanco
- CB Cromo Brillo
- CI Cuero Inglés
- CU Cuero
- CS Cromo Satinado
- LM Latón Mate
- NE Negro
- NMM Niq. Mate Mate
- NS Níquel Satinado
- NS/NB Niq. Sat / Niq. Br.
- PB Pulido Brillo
- PL Plata
- PS Pulido Satin.



AL

Ref.	mm (centr.)	CU	LM	NE	NS	PB	
SV-M150	200	10.90	10.90	10.90	10.68	10.90	1

AL

Ref.	mm (centr.)	NS/NB	
SV-M350	180	12.90	1

AL

Ref.	mm (centr.)	ANTR	BL	CB	CS	LM	NE	NS	
SV-M335	200	13.80	13.80	13.80	13.80	13.80	13.80	13.80	1

INOX

Ref.	mm (entre cent.)	NE	
EQ-M802 (Ø 25)	225 (200)	29.03	2
	325 (300)	32.91	2
	625 (600)	43.44	2
	925 (900)	57.06	2
	1225 (1200)	70.71	2



AL

Ref.	mm (centr.)	BL	LM	NE	NS	NS/NB	
SV-M200	200	10.90	10.90	10.90	10.68	12.90	1

AL

Ref.	mm (centr.)	BL	NE	NS	
SV-M600	200	16.15	16.15	16.15	1



NEW

AL

Ref.	mm (centr.)	NS	🔑
SV-MC15	200	14.50	1



AL

Ref.	mm (centr.)	NE	NS	🔑
SV-MC20	200	15.50	14.68	1



NEW

AL

Ref.	mm (centr.)	NS/NB	🔑
SV-MC35	200	16.72	1



AL

Ref.	mm (centr.)	BL	NE	NS	NS/NB	🔑
SV-M400	200	18.75	18.75	18.75	18.75	1



- AN Anticato
- ANTR Antracita
- BL Blanco
- CB Cromo Brillo
- CI Cuero Inglés
- CU Cuero
- CS Cromo Satinado
- LM Latón Mate
- NE Negro
- NMM Niq. Mate Mate
- NS Níquel Satinado
- NS/NB Niq. Sat / Níq. Br.
- PB Pulido Brillo
- PL Plata
- PS Pulido Satin.

* Medidas especiales consultar con el departamento comercial



INOX

Ref.	A (B)	NE	
EQ-M800 Ø30 mm	300 (210)	36.40	2
	400 (300)	40.78	2
	500 (300)	44.65	2
	600 (400)	51.80	2
	800 (600)	60.65	2
	1200 (900)	77.18	2
	1500 (1300)	91.90	1
1800 (1500)	109.55	1	

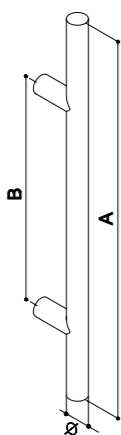

INOX

Ref.	A (B)	NE	
EQ-M810 Ø30 mm Desplazado 45°	300 (210)	45.61	2
	400 (300)	50.68	2
	500 (300)	56.85	2
	600 (400)	64.05	2
	800 (600)	77.53	2
1200 (900)	108.53	2	

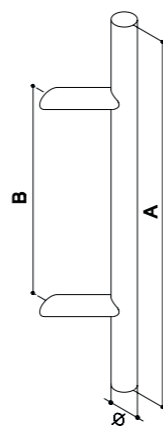

INOX

Ref.	A (B)	NE	
EQ-M831 ■25 x 25 mm	300 (210)	36.40	2
	400 (300)	40.78	2
	500 (300)	44.65	2
	600 (400)	51.80	2
	800 (600)	60.65	2
	1200 (900)	77.18	2
	1500 (1300)	91.90	1
1800 (1500)	109.55	1	

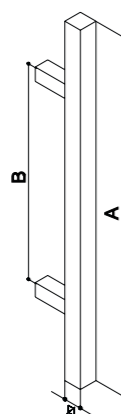

NEW

INOX

Ref.	A (B)	NE	
EQ-M861 ■25 x 25 mm Desplazado 45°	400 (210)	50.68	1
	500 (300)	56.85	1
	600 (400)	64.05	1
	700 (500)	70.28	1
	800 (600)	77.53	1
	1200 (900)	108.53	1

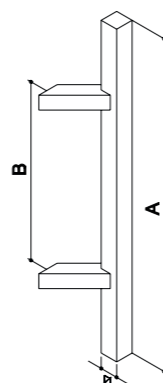

Manillones



- AN Anticato
- ANTR Antracita
- BL Blanco
- CB Cromo Brillo
- CI Cuero Inglés
- CU Cuero
- CS Cromo Satinado
- LM Latón Mate
- NE Negro
- NMM Niq. Mate Mate
- NS Niquel Satinado
- NS/NB Niq. Sat / Niq. Br.
- PB Pulido Brillo
- PL Plata
- PS Pulido Satin.



INOX

Ref.	A (B)	NE	■
SV-M360 (■ 20)	220 (200)	22.93	2
	270 (250)	24.53	2
	320 (300)	26.38	2
	420 (400)	28.73	2
	470 (450)	30.88	2

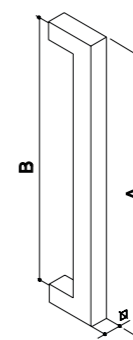

NEW

INOX

Ref.	A (B)	NE	■
EQ-M802K (■ 25)	225 (200)	27.90	2
	325 (300)	30.13	2
	625 (600)	39.45	2
	925 (900)	51.53	2
	1225 (1200)	63.70	2

- AN Anticato
- ANTR Antracita
- BL Blanco

- CB Cromo Brillo
- CI Cuero Inglés
- CU Cuero

- CS Cromo Satinado
- LM Latón Mate
- NE Negro

- NMM Niq. Mate Mate
- NS Niquel Satinado
- NS/NB Niq. Sat / Niq. Br.

- PB Pulido Brillo
- PL Plata
- PS Pulido Satin.



SV-C150



SV-MP15



SV-PP15

Ref.	mm	BL	CU	LM	NE	NS	PB	
SV-C150	242x45	16.40	16.40	16.40	16.40	16.40	16.40	2
SV-MP15	242x45	16.40	16.40	16.40	16.40	16.40	16.40	2
SV-PP15	242x45	19.78	19.78	19.78	19.78	19.78	19.78	2

AL / LAT

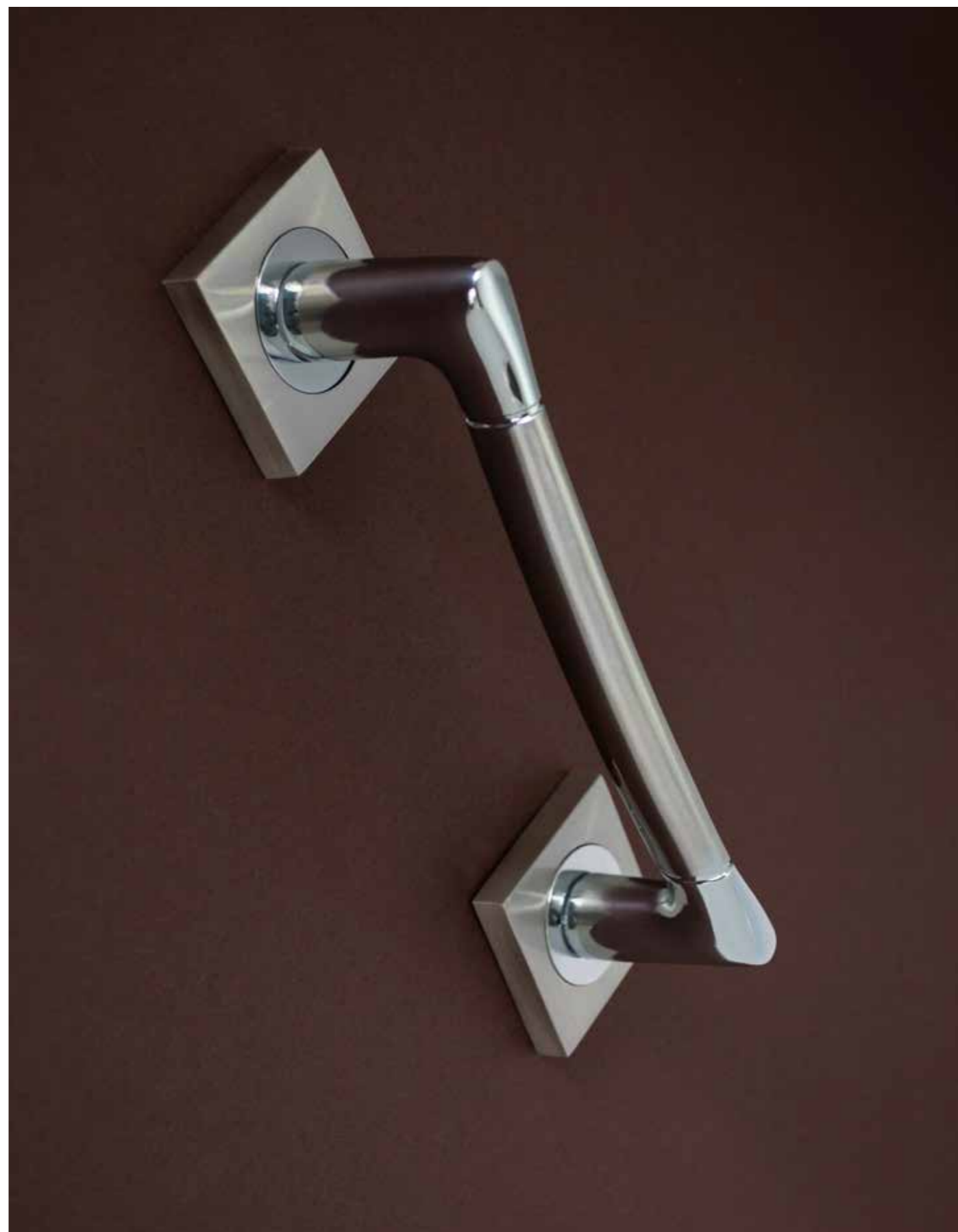

- AN Anticato
- ANTR Antracita
- BL Blanco
- CB Cromo Brillo
- CI Cuero Inglés
- CU Cuero
- CS Cromo Satinado
- LM Latón Mate
- NE Negro
- NMM Niq. Mate Mate
- NS Níquel Satinado
- NS/NB Niq. Sat / Níq. Br.
- PB Pulido Brillo
- PL Plata
- PS Pulido Satin.



ZK

Ref.	Ø mm	ANTR	BL	CU	LM	NE	NM	PB	🔌
EQ-285Z	50	3.43	3.43	3.43	3.43	3.43	2.48	3.43	10



ZK

Ref.	Ø mm	ANTR	BL	CU	LM	NE	NS	PB	🔌
SV-BR25	50	3.43	3.43	3.43	3.43	3.43	2.48	3.43	10



ZK

Ref.	mm	ANTR	BL	CB	CS	NE	NS	NS/NB	🔌
SV-BC15	50x50	3.58	3.58	3.58	3.58	3.58	3.58	3.58	10
SV-BC25	50x50	4.25	4.25	4.25	4.25	4.25	4.25	-	10

INOX

Ref.	Ø mm	NE	🔌
SV-B304	52	2.75	10
SV-B305	52	2.75	10



INOX

Ref.	mm	NE	🔌
SV-B303	50x50	2.78	10
SV-B308	50x50	2.43	10



ZK

Ref.	mm	ANTR	BL	CB	CI	CS	LM	NE	NMM	NS	🔌
SV-CC35	35x35	7.95	7.45	7.45	6.80	7.45	7.45	7.45	7.45	6.35	5



ZK

Ref.	Ømm	ANTR	BL	CU	LM	NE	NS	PB	🔌
SV-CR50	50	8.50	8.50	8.50	8.50	8.50	6.80	8.50	2



ZK

Ref.	Ømm	ANTR	BL	CU	LM	NE	NMM	NS	PB	🔌
SV-495	35	6.80	6.38	6.38	6.38	6.38	6.38	4.60	6.38	5



ZK

Ref.	mm	ANTR	BL	CB	CS	NE	NS	NS/NB	🔌
SV-CC50	50x50	9.83	9.83	9.83	9.83	9.83	8.55	9.83	2



ZK

Ref.	AN	ANTR	BL	CI	CS	CU	LM	NE	NMM	NS	PB	PL	🔌
EQ-1197	3.05	3.05	3.05	3.05	3.05	3.05	3.05	3.05	3.05	3.05	3.05	3.05	10



ZK

Ref.	BL	CB	CI	CS	CU	LM	NE	NS	PB	🔌
C902	2.78	2.78	2.78	2.78	2.78	2.78	2.78	2.78	2.78	20

- AN Anticato
- ANTR Antracita
- BL Blanco
- CB Cromo Brillo
- CI Cuero Inglés
- CU Cuero
- CS Cromo Satinado
- LM Latón Mate
- NE Negro
- NMM Niq. Mate Mate
- NS Níquel Satinado
- NS/NB Niq. Sat / Niq. Br.
- PB Pulido Brillo
- PL Plata
- PS Pulido Satin.



ZK

Ref.	BL	CB	CS	NE	NS	PB	
SVDEDALC	1.68	1.68	1.68	1.68	1.68	-	20
SVDEDALR	1.68	1.68	1.68	1.68	1.68	1.68	20

ZK

Ref.	ANTR	BL	CB	CS	CU	LM	NE	NS	PB		
SV-CCDR	6.05	5.70	5.70	5.70	5.70	5.70	5.70	5.40	5.70	1	20

Ø56 mm (Ø48 interior)



ZK

Ref.	ANTR	BL	CB	CS	CU	LM	NE	NS	PB		
SV-KITR	12.95	12.53	12.53	12.53	12.53	12.53	12.53	10.48	12.53	1	20

Ø56 mm (Ø48 interior)
Frontal 16 mm.



ZK

Ref.	BL	CB	CS	CU	LM	NE	NS	PB		
KITR20	15.30	15.30	15.30	15.30	15.30	15.30	14.13	15.30	1	20

Ø56 mm (Ø48 interior)
Frontal 20 mm. Especial para picaporte unificado de 70 mm.



ZK

Ref.	ANTR	BL	CB	CS	LM	NE	NS		
SV-CCDC	6.65	6.05	6.05	6.05	6.05	6.05	5.68	1	20

56 x 56 mm (Ø48 interior)



ZK

Ref.	ANTR	BL	CB	CS	LM	NE	NS		
SV-KITC	13.35	12.75	12.75	12.75	12.75	12.75	12.55	1	20

56 x 56 (Ø48 interior)
Frontal 16 mm.



ZK

Ref.	BL	CB	CS	NE	NS		
KITC20	13.90	13.90	13.90	13.90	13.63	1	20

56 x 56 mm (Ø48 interior)
Frontal 20 mm. Especial para picaporte unificado de 70 mm.



NEW

ZK

Ref.	NS	
PICOLORO	7.50	10

- AN Anticato
- ANTR Antracita
- BL Blanco
- CB Cromo Brillo
- CI Cuero Inglés
- CU Cuero
- CS Cromo Satinado
- LM Latón Mate
- NE Negro
- NMM Niq. Mate Mate
- NS Niquel Satinado
- NS/NB Niq. Sat / Niq. Br.
- PB Pulido Brillo
- PL Plata
- PS Pulido Satin.



Kits corredera con bombillo 40 mm con 3 llaves



ZK

Ref.	mm	CU	NE	NS	PB	📦
SV-KITB	Ø56 (Ø48 int.)	25.70	25.70	25.70	25.70	1

ZK

Ref.	mm	CB	CS	NE	NS	📦
SV-KITBC	■ 56 (Ø48 int.)	29.60	29.60	29.60	29.60	1



ZK

Ref.	mm	ANTR	BL	CU	NE	NS	PB	📦
PU-47	47	4.75	4.35	4.35	4.35	4.10	4.35	10
PU-70	70	6.35	5.85	5.85	5.85	4.55	5.85	10



ZK

Ref.	mm	CU	LM	NE	NS	📦
SV-PSMN	Ø70	7.20	7.20	7.20	6.93	15



ZK

Ref.	Ø mm	MIXTA	NS	PB	📦
MR-2542	14(25-42)	2.04	2.04	2.04	12

*Se suministran por cajas



ZK

Ref.	Ø mm	MIXTA	NE	NS	PB	📦
MR-3560	14(35-60)	2.38	2.38	2.38	2.38	12

*Se suministran por cajas



ZK

Ref.	Ø mm	NE	NS	📦
SV-TOPE	22x30	3.98	3.98	25



AL

Ref.	mm	ANTR	BL	CB	CI	CS	CU	LM	NE	NS	PB	📦
SV-T150	129x34	5.28	4.68	4.68	4.68	4.68	4.68	4.68	4.68	4.68	4.68	20
SV-A150	79x34	4.45	3.85	3.85	3.85	3.85	3.85	3.85	3.85	3.85	3.85	20



AL

Ref.	mm	ANTR	BL	CB	CI	CS	LM	NE	NS	PB	📦
SV-T401	132x38	5.28	4.68	4.68	4.68	4.68	4.68	4.68	4.68	4.68	20
SV-A401	81x34	4.45	3.85	3.85	3.85	3.85	3.85	3.85	3.85	3.85	20

- AN Anticato
- ANTR Antracita
- BL Blanco
- CB Cromo Brillo
- CI Cuero Inglés
- CU Cuero
- CS Cromo Satinado
- LM Latón Mate
- NE Negro
- NMM Niq. Mate Mate
- NS Niquel Satinado
- NS/NB Niq. Sat / Niq. Br.
- PB Pulido Brillo
- PL Plata
- PS Pulido Satin.



ZK

Ref.	mm	ANTR	BL	CU	NE	NS	PB		
PH-100D	100x57x2	1.68	1.20	1.20	1.20	1.20	1.20	20	240
PH-100I	100x57x2	1.68	1.20	1.20	1.20	1.20	1.20	20	240

*Se suministran por cajas



ZK

Ref.	mm	BL	CU	NE	NS	PB		
PH-95D	95x54x2	1.20	1.20	1.20	1.20	1.20	20	240
PH-95I	95x54x2	1.20	1.20	1.20	1.20	1.20	20	240

*Se suministran por cajas



ZK

Ref.	mm	BL	CU	LM	NE		
BH-90CD	90x65x2.5	2.20	2.20	2.20	2.20	10	100
BH-90CI	90x65x2.5	2.20	2.20	2.20	2.20	10	100
BH-80CD	80x60x2.5	-	2.25	2.25	2.25	10	100
BH-80CI	80x60x2.5	-	2.25	2.25	2.25	10	100

*Se suministran por cajas



ZK

Ref.	mm	BL	CU	LM	NE		
BH-90RD	90x65x2.5	2.20	2.20	2.20	2.20	10	100
BH-90RI	90x65x2.5	2.20	2.20	2.20	2.20	10	100

*Se suministran por cajas



INOX

Ref.	mm	INOX		
PI-100D	100x57x2	1.70	20	240
PI-100I	100x57x2	1.70	20	240

*Se suministran por cajas



INOX

Ref.	mm	INOX		
PI-95D	95x53x2	1.70	20	240
PI-95I	95x53x2	1.70	20	240

*Se suministran por cajas



INOX

Ref.	mm	INOX		
BI-90CD	90x65x2.5	2.48	10	100
BI-90CI	90x65x2.5	2.48	10	100
BI-80CD	80x60x2.5	2.53	10	100
BI-80CI	80x60x2.5	2.53	10	100

*Se suministran por cajas



INOX

Ref.	mm	INOX		
BI-90RD	90x65x2.5	2.48	10	100
BI-90RI	90x65x2.5	2.48	10	100

*Se suministran por cajas

- AN Anticato
- ANTR Antracita
- BL Blanco
- CB Cromo Brillo
- CI Cuero Inglés
- CU Cuero
- CS Cromo Satinado
- LM Latón Mate
- NE Negro
- NMM Niq. Mate Mate
- NS Niquel Satinado
- NS/NB Niq. Sat / Niq. Br.
- PB Pulido Brillo
- PL Plata
- PS Pulido Satin.

Accesorios Técnicos

*Taladro condena y desbloqueo 1€ Neto
 *Taladro bocallave 0,50€ Neto
 *Taladro bocallave cortinilla 2,50€ Neto



NEW

AL

Ref.	mm	NE	NS	🔌
SV-PR	242x45	5.05	5.05	10

NEW

AL

Ref.	mm	NE	NS	🔌
SV-PC	255x50	5.68	5.68	10



8x8
3.80

Fijación expositor cuadradillo



Ø8
3.80

Fijación expositor roscado pomo



8x85	8x120	8x150	8x200
0.92	1.16	1.96	6.90

Cuadrillo fresado de 8 mm



6x80	6x100	6x120
0.74	0.92	1.62

Cuadrillo fresado de 6 mm



de 7 a 6	de 8 a 6	de 8 a 7
0.52	0.52	0.52

Reductor



8x65	8x85
4.20	4.20

Cuadrillo de expansión



Muelle
0.70

Muelle espiral



- PB Pulido Brillo
- CU Cuero
- NS/NB Níq. Sat / Níq. Br
- BL Blanco
- AN Anticato
- PS Pulido Satin.
- CI Cuero Inglés
- LM Latón Mate
- CS Cromo Satinado
- NMM Níq. Mate Mate
- NS Níquel Satin.
- CB Cromo Brillo
- NE Negro
- PL Plata





LINEA INOX

ELEVADA RESISTENCIA
A LA CORROSIÓN





Ref.	mm	INOX	NE		
SV-R302	Ø 52	7.43	11.60	1	20





Ref.	mm	INOX		
SV-X302	60x32	10.20	1	20





Ref.	mm	INOX		
SV-F302	170x170	28.05	1	10





Ref.	mm	INOX		
SV-G302	60x32	8.23	2	20





Ref.	INOX		
SV-E302	19.10	2	20



Ref.	INOX		
SV-P301	18.45	1	20



Ref.	INOX	NE		
SV-P302	17.53	20.70	1	20



Ref.	mm	INOX		
SV-R336	Ø 52	8.38	1	20



Ref.	mm	INOX		
SV-X336	60x32	10.33	1	20



Ref.	mm	INOX		
SV-F336	170x170	25.08	1	10



Ref.	mm	INOX	NE		
SV-R338	Ø 52	8.38	13.33	1	20



Ref.	mm	INOX		
SV-X338	60x32	10.33	1	20



Ref.	mm	INOX		
SV-G338	60x32	8.63	4	20



Ref.	mm	INOX		
SV-G336	60x32	8.63	4	20

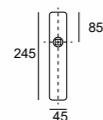

Ref.	INOX		
SV-P336	18.65	1	20

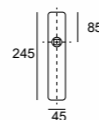

Ref.	INOX		
SV-P337	17.53	1	20

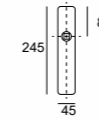

Ref.	INOX		
SV-P338	18.65	1	20

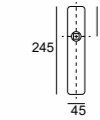

Ref.	INOX	NE		
SV-P339	17.53	20.68	1	20

INOX, elevada
resistencia a la corrosión

NEW



Ref.	mm	INOX		
SV-R318 MACIZA	Ø 52	25.83	1	20
SV-R358 HUECA	Ø 52	12.35	1	20

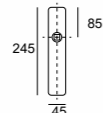

Ref.	INOX		
SV-P319	34.25	1	20



Ref.	mm	INOX		
SV-C334	50x50	15.88	1	20

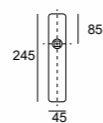

Ref.	INOX		
SV-P318	36.05	1	20

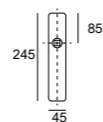

Ref.	INOX		
SV-P334	21.08	1	20

NEW



Ref.	mm	INOX		
SV-R258	Ø 52	11.23	1	20

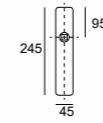

NEW

Ref.	INOX		
SV-P258	14.98	1	20

NEW



Ref.	mm	INOX		
SV-C413	53x53	13.35	1	20

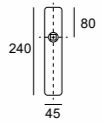

NEW

Ref.	INOX		
SV-P413	16.08	1	20



JANDEL INOX

JANDEL INOX



Ref.	mm (entre cent.)	INOX	NE	
SV-M302	150	7.33	-	2
	200	9.08	10.98	1
	250	9.43	-	1
	300	9.85	-	1



Ref.	mm (entre cent.)	INOX	
SV-M318	200	34.50	1



Ref.	mm (entre cent.)	INOX	NE	
SV-M338	150	7.13	-	1
	200	9.73	12.53	1



NEW

Ref.	mm (entre cent.)	INOX	
SV-M258	200	14.90	1



Ref.	mm (entre cent.)	INOX	
SV-M365	200	23.80	1



Ref.	mm (entre cent.)	INOX	
SV-M360 (20x20)	200	18.38	2
	250	19.75	2
	300	20.85	2
	400	21.75	2
	450	22.73	2

Manillones



Ref.	INOX	NE	
SV-MP32	11.90	16.63	2

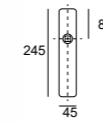

Ref.	INOX	
SV-PP32	13.63	2

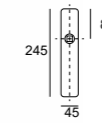

Ref.	INOX	
SV-LP30	10.48	2



Ref.	mm	INOX	
SV-MF32	170x170	15,13	2



Ref.	mm	INOX	
SV-LF30	170x170	12.30	5

MANILLONES
GRAN FORMATO



NEW

Ref.	A (B)	INOX	
EQ-M861 ■ 25 x 25 mm Desplazado 45°	400 (210)	47.03	1
	500 (300)	52.18	1
	600 (400)	59.40	1
	700 (500)	64.55	1
	800 (600)	70.73	1
	1200 (900)	101.75	1

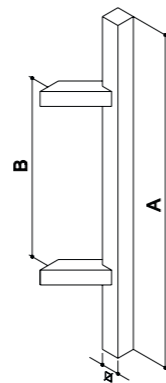



MANILLONES
GRAN FORMATO

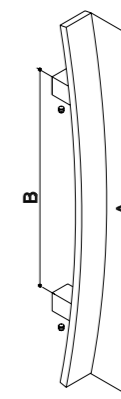

NEW

Ref.	A (B)	INOX	
EQ-M851 40 x 10 mm	400 (210)	44.83	1
	500 (300)	47.75	1
	600 (400)	53.63	1
	800 (600)	68.28	1
	1200 (900)	83.52	1
1500 (1300)	101.05	1	

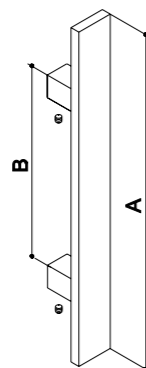

Ref.	A (B)	INOX	
EQ-M841 40 x 10 mm	500 (300)	57.35	1
	600 (400)	63.53	1
	800 (600)	75.90	1

* Medidas especiales consultar con el departamento comercial

* Medidas especiales consultar con el departamento comercial



Ref.	mm (entre cent.)	INOX	
EQ-M800 (Ø30)	300 (210)	28.88	2
	400 (300)	33.15	2
	500 (300)	36.35	2
	600 (400)	40.58	2
	800 (600)	49.15	2
	1200 (900)	61.98	2
	1500 (1300)	73.05	1
	1800 (1500)	86.95	1

Ref.	mm (entre cent.)	INOX	
EQ-M810 (Ø30) Desplazado 45°	300 (210)	37.81	2
	400 (300)	45.50	2
	500 (300)	50.68	2
	600 (400)	57.90	2
	800 (600)	69.23	2
	1200 (900)	100.25	2

Ref.	mm (entre cent.)	INOX	
EQ-M831 (■ 25)	300 (210)	28.88	2
	400 (300)	33.15	2
	500 (300)	36.35	2
	600 (400)	40.58	2
	800 (600)	49.15	2
	1200 (900)	61.98	2
	1500 (1300)	73.05	1
	1800 (1500)	86.95	1

Ref.	mm (entre cent.)	INOX	
EQ-M801 (Ø 25)	425 (400)	23.68	2
	625 (600)	30.10	2

Ref.	mm (entre cent.)	INOX	
EQ-M802 (Ø 25)	225 (200)	26.95	2
	325 (300)	28.75	2
	625 (600)	35.15	2
	925 (900)	43.33	2
	1225 (1200)	55.05	2

Ref.	mm (entre cent.)	INOX	
EQ-M802K (■ 25)	225 (200)	25.98	2
	325 (300)	27.90	2
	625 (600)	33.98	2
	925 (900)	41.62	2
	1225 (1200)	52.65	2



Ref.	mm	INOX	
SV-340	Ø 35	8.23	1



Ref.	mm	INOX	PVLM	
SV-345	Ø 50	9.25	15.53	1



Ref.	mm	INOX	
SV-346	35 x 35	9.88	1



Ref.	mm	INOX	
SV-347	50 x 50	9.50	1



Ref.	mm	INOX	
SV-348	Ø 50	9.93	1



Ref.	mm	INOX	NE	
SV-B304	Ø 50	1.40	2.75	20



Ref.	mm	INOX	NE	
SV-B303	50 x 50	1.63	2.78	20



Ref.	mm	INOX	NE	
SV-B308	50 x 50	1.63	2.43	20



Ref.	mm	INOX	NE	
SV-B306	60 x 32	1.63	2.10	20



Ref.	mm	INOX	NE	
SV-B305	Ø 50	1.40	2.75	20



Ref.	mm	INOX	
SV-B307	Ø 50	1.40	20



Ref.	mm	INOX	
SV-B309	Ø 35	1.95	20



Ref.	INOX	
SV-1198	7.53	20



Ref.	mm	INOX	
SV-HUELLA15	15 x 26	2.35	25



Ref.	mm	INOX	
SV-HUELLA20	20 x 28	2.70	25





Ref.	mm	INOX	
SV-TOPE	22x30	2.80	25



Ref.	mm	INOX	
SV-8510	Ø56 (Ø48 interior)	32.45	1





Ref.	mm	INOX	NE		
SV-170P	70 x 70	17.15	29.65	1	48



Ref.	mm	INOX	
SV-8610	Ø56 (Ø48 interior)	16.23	1



Ref.	mm	INOX		
SV-172P	Ø 85	10.70	1	48



Ref.	mm	BL	CB	CM	NE	NM
M04A	45X20	2.36	2.26	2.26	2.36	1.92



Ref.	mm	CM	NM
M27A	25X25	1.30	1.38



Ref.	mm	CM	NM
M26A	34X30	2.08	2.50
M26B	25X21	1.24	1.82



Ref.	mm	CM	NM
M28A	Ø 32	2.76	3.16

Ref.	mm	CM	NM
M03A	192	5.20	6.38



Ref.	mm	CM	NM
M07A	128	3.38	4.78



Ref.	mm	CB	CM	NM
M09A	128	4.48	4.04	5.90
M09B	96	3.56	3.14	4.76



Ref.	mm	CM	NE	NM
M10A	192	7.76	6.66	9.64
M10B	128	5.38	6.04	7.04



Ref.	mm	CM	NM
M11A	192	11.26	11.26
M11B	128	8.08	8.08



Ref.	mm	CM	NM
M12A	192	9.12	9.03
M12B	160	6.20	7.88
M12C	128	4.54	5.74



Ref.	mm	BL	CM	NE	NM
M13A	240	6.78	5.04	6.76	8.70
M13B	160	4.78	4.16	4.16	4.74
M13C	128	4.38	4.20	4.56	5.06



Ref.	mm	CM	NM
M14A	320	6.82	8.96
M14B	224	5.56	7.50
M14C	128	3.80	4.36
M14D	96	3.30	3.92



Ref.	mm	CM	NM
M22A	256	7.72	7.72
M22B	160	5.14	5.14
M22C	128	4.58	4.58



Ref.	mm	NM
M23A	792 / Ø12	15.34
M23B	692 / Ø12	14.46
M23C	592 / Ø12	13.64
M23D	492 / Ø12	11.88
M23E	442 / Ø12	11.16
M23F	392 / Ø12	10.34
M23G	342 / Ø12	9.72
M23H	292 / Ø12	8.32
M23I	242 / Ø12	7.36
M23J	192 / Ø12	6.28
M23K	160 / Ø12	5.50
M23L	128 / Ø12	4.80
M23M	96 / Ø12	4.06



Ref.	mm	CM	NM
M24A	128	3.20	4.82
M24B	96	2.04	2.44
M24C	64	1.60	1.82



Ref.	mm	CM	NM
M25A	128	3.28	3.70



Ref.	mm	CM	NM
M29A	128	4.52	5.78

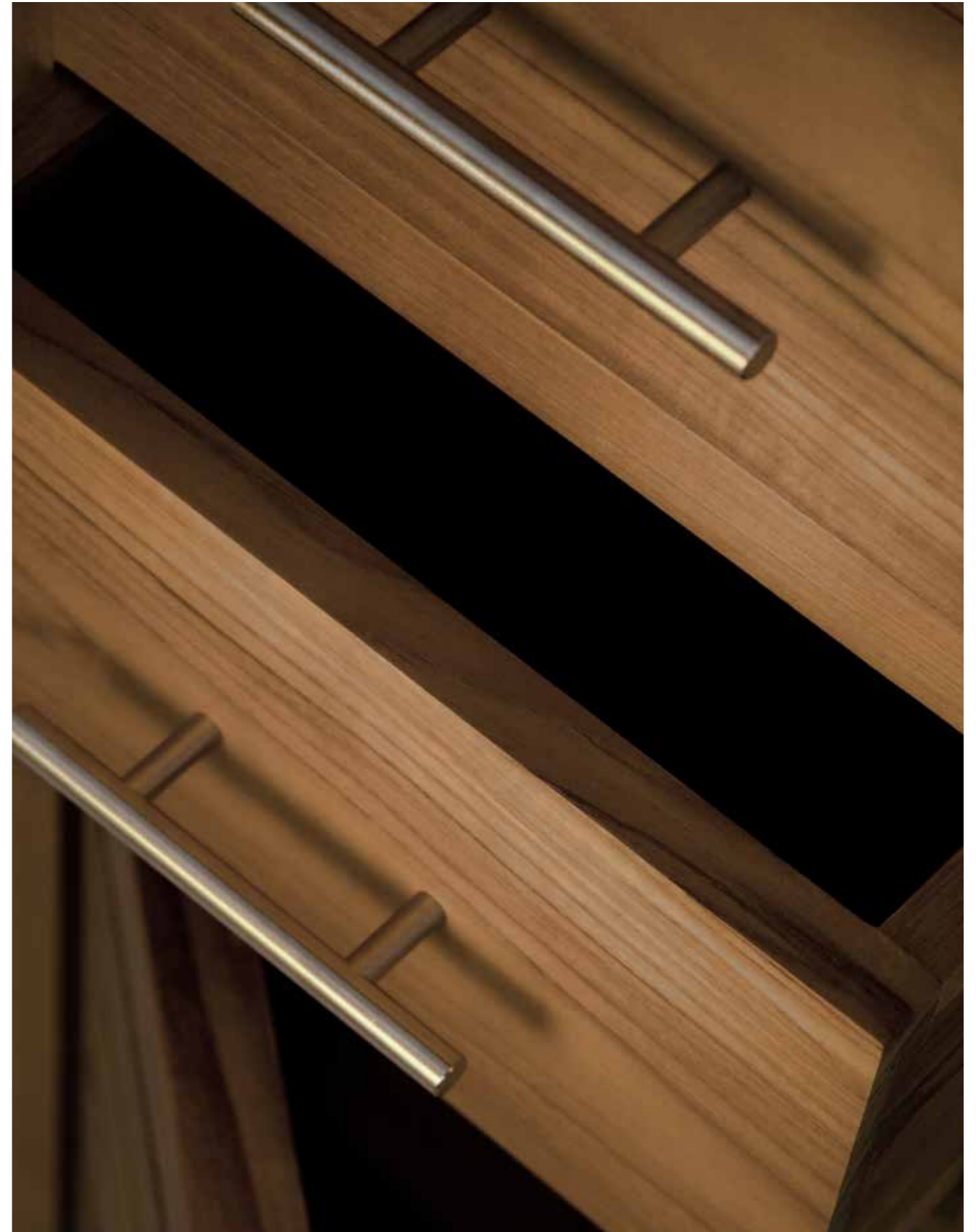



Ref.	mm	CM	CU
H55A	34x28	3.16	3.24
H55B	22x22	2.74	2.90

Ref.	mm	CB	CM	CU
H95A	47x47	10.80	6.24	9.02
H95B	37x37	8.64	4.76	7.10



Ref.	mm	CM	CU
H76A	24x21	2.52	2.86

Ref.	mm	CB	CM	CU	PL
H102	37x37	12.88	7.02	7.88	9.16



Ref.	mm	CM	CU	PL
H93A	37x26	4.54	5.40	5.84
H93B	25x18	3.60	3.46	3.86

Ref.	mm	CB	CM	CU	PL
H103	23x23	8.86	3.68	4.90	5.24

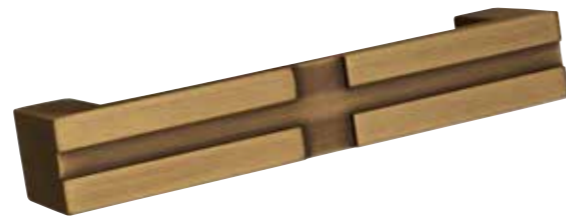

Ref.	mm	CM	CU	PL
H94A	96	6.92	6.66	7.44

Ref.	mm	CU	PL
H113	128	8.26	7.92





Ref.	mm	CB	CM	CU	PL
H107	Ø41 (32 entre centros)	7.66	3.94	5.16	5.36



Ref.	mm	CB	CM	CU	PL
H115	140x28 (96 entre centros)	17.38	9.34	12.28	12.83



Ref.	mm	CB	CM	CU	PL
H108	Ø78 (64 entre centros)	11.46	7.22	8.26	9.01



Ref.	mm	CU	PL
H120	96	7.78	7.96



Ref.	mm	CB	CM	CU	PL
H111	96	7.82	4.16	5.50	5.58



Ref.	mm	CU	PL
H121	50x50	7.70	7.88



Ref.	mm	CB	CM	CU	PL
H112	64	7.06	3.82	4.76	4.85



Ref.	mm	CU	PL
H122	35x35	5.32	5.54



Ref.	mm	CB	CM	CU	PL
H123	Ø62	12.92	9.68	10.46	10.68



Ref.	mm	CB	CM	CU	PL
H124	Ø50	9.30	6.43	7.40	7.62



Ref.	mm	CB	CM	CU	PL
H125	Ø28	6.44	4.16	4.90	4.90





Ref.	mm	CU	PL
H126	50x50	9.64	9.90



Ref.	mm	CU	PL
H127	35x35	7.48	7.82



Ref.	mm	CU	PL
H128	22x22	5.28	5.40



Ref.	mm	CU	PL
H129	68x68	15.38	15.52



Ref.	mm	CU	PL
H130	50x50	10.76	11.24



Ref.	mm	CU	PL
H131	40x40	8.44	8.90



Ref.	mm	CB	CU	PL
H132	58x58	13.70	11.58	11.72



Ref.	mm	CB	CU	PL
H133	45x45	10.38	8.34	8.64



Ref.	mm	CB	CU	PL
H134	37x37	9.90	7.40	7.62

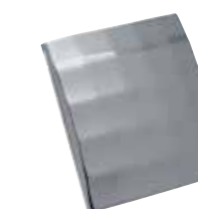

Ref.	mm	CB	CU	PL
H135	28x28	7.40	5.54	5.80



Ref.	mm	CM
H136	250 (128 entre centros)	14.02



Ref.	mm	CM
H137	180 (128 entre centros)	10.68

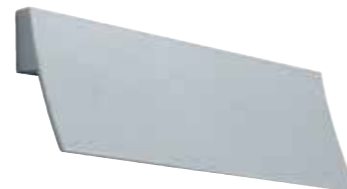

Ref.	mm	CM
H138	110 (64 entre centros)	7.92



Ref.	mm	CB	CM
H140	64 (entre centros)	12.14	7.74



Ref.	mm	NS
SV-HUELLA	Ø20	2.20

jandel



C/Dels Fusters, 19. P. I. Els Mollons · 46970 Alaquàs (Valencia) Spain
Tel. +34 963111845 · info@jandel.es · pedidos@jandel.es
www.jandel.es